

## DECOSTAR 51 TITAN 20 W 12 V 60° GU5.3

DECOSTAR 51 TITAN | Halogen longlife dichroic reflector lamps 51 mm and glass panel



### Areas of application

- General illumination
- Shops
- Restaurants, hotels and similar prestigious applications
- Offices, public buildings

### Product benefits

- Brilliant accent light
- Constant bluish appearance of the light escaping at the back of the reflector
- Dichroic reflector reduces the heat in the light beam by up to 66 %
- Constant luminous intensity and constant color location throughout
- Flat clear shield
- Approved for use in open luminaires (to IEC 60598-1)
- UV filter
- Contains no mercury

### Product features

- Average life: 4,000 h
- Dimmable
- Color rendering index  $R_a$ : 100
- Color temperature: 3,000 K

---

## Technical data

---

### Electrical data

Nominal wattage	20 W
Nominal voltage	12 V
Rated wattage	20 W
Power factor $\lambda$	1.00
Energy consumption	22 kWh/1000h

### Light technical data

Nominal useful luminous flux 90°	250 lm
Luminous intensity	350 cd
Beam angle	60 °
Color temperature	3000 K
Light color as per EN 12464-1	Warm White
Color rendering index Ra	100
Starting time	0.0 s
Warm-up time (60 %)	0.00 s
Lumen main.fact.at end of nom.life time	0.75
Rated useful luminous flux 90°	250 lm

### Dimensions & weight

---

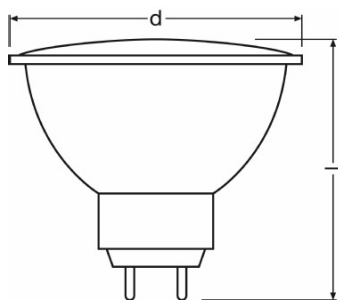

### Product line drawing

Diameter	51.0 mm
Length	46.0 mm
Overall length	46.0 mm
Outer bulb	MR51

## Product datasheet

Maximum diameter	51.0 mm
------------------	---------

### Colors & materials

Lamp mercury content	0.0 mg
Mercury-free	Yes

### Lifespan

Nominal lamp life time	4000 h
Rated lamp life time	4000 h
Number of switching cycles	100000 <sup>1)</sup>

<sup>1)</sup> At 1 min on / 3 min off

### Additional product data

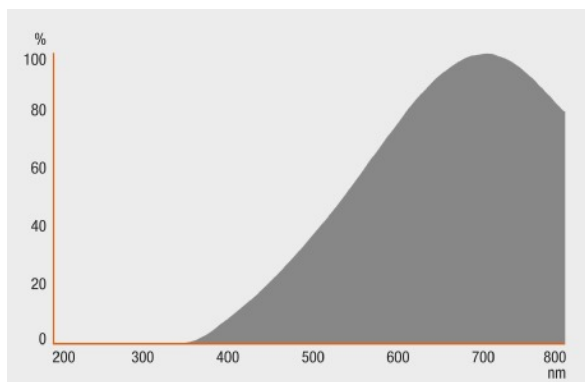

### Spectral power distribution

Base (standard designation)	GU5.3
-----------------------------	-------

### Capabilities

Burning position	Any
Dimmable	Yes

### Certificates & standards

Energy efficiency class	B
-------------------------	---

## Product datasheet

### Country specific categorizations

<b>ILCOS</b>	HRGS//UB-20-12-GU5,3-51/60
<b>Order reference</b>	46860 VWFL

### Country specific information

<b>Product code</b>	<b>METEL code</b>	<b>SEG number</b>	<b>STK number</b>	<b>UK Org</b>
4050300428673	OSRH46860VWFL	8326946	4739634	-

## Product datasheet

---

### Logistical Data

---

Product code	Product description	Packaging unit (Pieces/Unit)	Dimensions (height x width x length)	Volume	Gross weight
4050300428673	DECOSTAR 51 TITAN 20 W 12 V 60° GU5.3	Folding carton box 1	46 mm x 46 mm x 58 mm	0.12 dm <sup>3</sup>	38.00 g
4050300531816	DECOSTAR 51 TITAN 20 W 12 V 60° GU5.3	Shipping carton box 20	106 mm x 122 mm x 238 mm	3.08 dm <sup>3</sup>	836.00 g

---

The mentioned product code describes the smallest quantity unit which can be ordered. One shipping unit can contain one or more single products. When placing an order, for the quantity please enter single or multiples of a shipping unit.

---

### References / Links

---

For light distribution curves see

▶ [www.osram.com](http://www.osram.com)

---

### Disclaimer

---

Subject to change without notice. Errors and omission excepted. Always make sure to use the most recent release.