



ENGLISH

Datasheet

DC Axial Fan, 120 x 120 x 38.5mm, 178.8m/h, 4.7W, 12 V dc (OD1238 Series)

RS Stock number [668-8851](#)

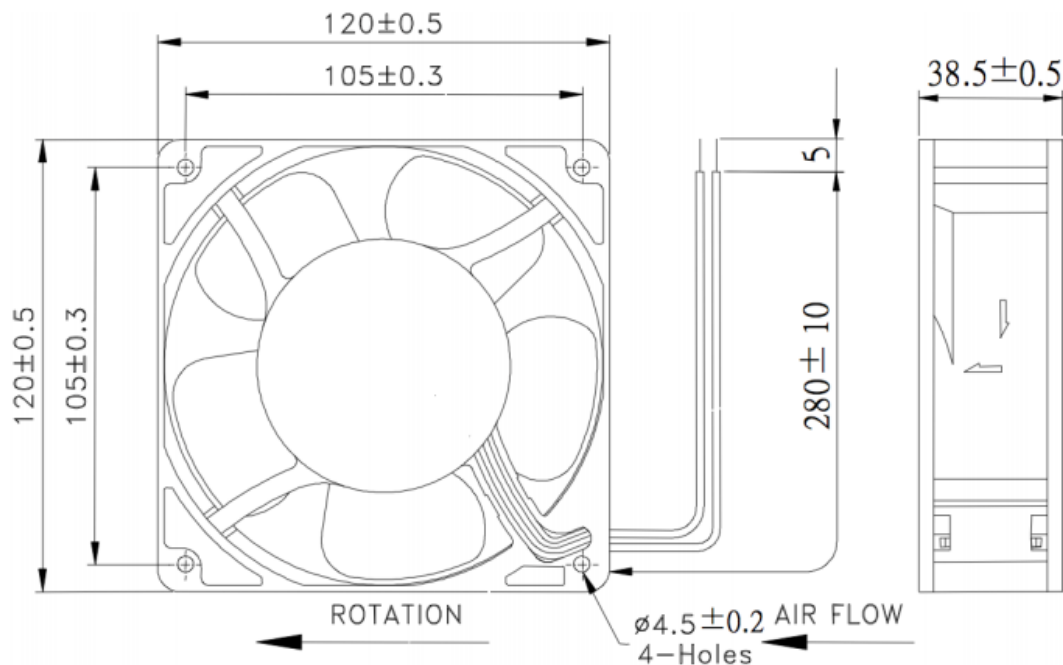

RS Order Number	6688851	6688855
Model Number	OD1238-12HSS	OD1238-24MSS
Nominal Voltage	12 VDC	24 VDC
Rated Power	4.7 W	4.8 W
Nominal Current	0.50 A	0.23 A
Rated Speed (RPM)	2800	2540
Airflow (CFM)	105	96
Noise Level (dB)	47	47
Max. Static Pressure	0.27" H2O	0.23" H2O

Drawing(mm):

Specifications:

Frame & Impeller:	PBT, UL94V-O plastic
Connection:	2x Lead wires 24AWG
Motor:	Brushless DC, auto restart, polarity protected
Bearing System:	Sealed sleeve
Insulation Resistance:	10M ohm between lead wire and frame (500VDC)
Dielectric Strength:	1 second at 500 VAC, max leakage – 500 MicroAmp
Operating Temp:	-10°C ~ 70°C
Life Expectancy(L10):	50,000 hours

Available Options:

- Sleeve bearing
- Ball bearing
- Tachometer
- Alarm
- Thermal control
- PWM input
- IP55
- 48V & 5V