



MASTER LEDspot MV

MASTER LEDspotMV VLE D 5.3-50W GU10 827 36D

Delivering a warm, halogen-like accent beam, MASTER LEDspot MV is a perfect fit for spot lighting (track, corridors, lift lobbies, display cases and cabinets) in the hospitality industry. It is particularly suitable to public areas where the light is on 24/7, such as lobbies, corridors, stairwells. MASTER LEDspot MV delivers huge energy savings and minimizes maintenance cost without any compromise on brightness, enabling hospitality owners to achieve a return on their investment within one year. These LEDspots are compatible with most existing fixtures with a GU10 holder and designed as a retrofit replacement for halogen or incandescent spots. The dimmable versions drive further efficiencies, while helping to create the desired atmosphere.

Product data

• General Characteristics

Cap-Base	GU10
Bulb	PAR16 [PAR 2inch]
Rated Lifetime (hours)	25000 hr
Nominal Lifetime hours	25000 hr

• Light Technical Characteristics

Color Code	827
Color Designation (text)	Warm White
Beam Angle	36 D
Beam Description	36D [Medium beam]
Correlated Color Temperature	2700 K
Luminous Flux	385 Lm
Luminous Intensity	950 cd
Color rendering index	80
Luminous Efficacy Lamp	72.64 Lm/W
Color Temperature	2700 K [CCT 2700K]
Rated Luminous Flux	385 Lm
LLMF - end nominal lifetime	70 %
Colour consistency	6 steps
Rated Beam Angle	36 D
Luminous flux in 90° cone	355 Lm

• Electrical Characteristics

Wattage	5.3 W
Voltage	220-240 V
Line Frequency	50-60 Hz

Power Factor	0.5 -
Lamp Current mA	29 mA
Dimmable	Yes
Wattage Equivalent	50 W
Rated Wattage	5.3 W
Starting Time	0.5 (max) s
Warm-up Time to 60% Light Outp	instant full light
Suitable for accent lighting	Yes

• Temperature Characteristics

T-case maximum	75 C
----------------	------

• Environmental characteristics

Energy Efficiency Label (EEL)	A+
-------------------------------	----

• Measuring Conditions

Switching cycle	50000X
-----------------	--------

• Product Dimensions

Overall Length C	55 mm
Diameter D	50 mm

• Product Data

Order code	929001111002
Full product code	929001111002
Full product name	MASTER LEDspotMV VLE D 5.3-50W GU10 827 36D
Order product name	MAS LEDspotMV VLE D 5.3-50W GU10 827 36D



PHILIPS

MASTER LEDspot MV

Pieces per pack 1
Packing configuration 10
Packs per outerbox 10
Bar code on pack - EAN1 8718291735403

Bar code on outerbox - EAN3 8718291735410
Logistic code(s) - 12NC 929001111002
Net weight per piece 0.038 kg

Warnings and Safety

- Operating temperature range is between -20° C and 45° C ambient
- Only to apply in dry or damp locations and most of open fixtures with lamp-holders that offer sufficient space (10 mm free air space)
- Not intended for use with emergency light fixtures or exit lights

Dimensional drawing

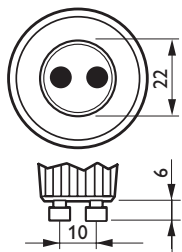
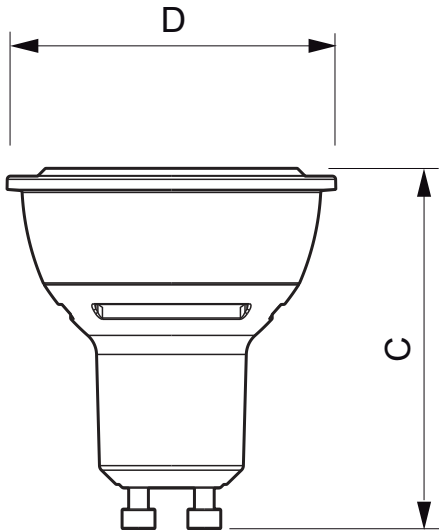

GU10

MASTER LEDspotMV VLE D 5.3-50W GU10 827 36D

Product	C (Norm)	C1 (Max)	D (Norm)	D1 (Norm)
LED VLE D 5.3-50W GU10 827 36D	55	-	50	-

Photometric data

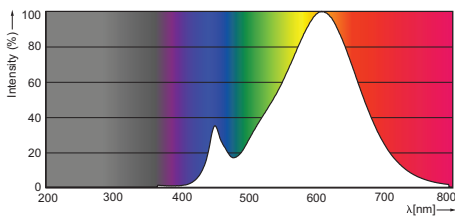

PAR16 /827 2700 K 36D



© 2014 Koninklijke Philips N.V. (Royal Philips)
All rights reserved.

Specifications are subject to change without notice. Trademarks are the property of Koninklijke Philips N.V. (Royal Philips) or their respective owners.

www.philips.com/lighting

2014, July 27
data subject to change