

M 238



Euromas
 Euromas enclosure, polycarbonate

Order no.: 02238000

Colour of enclosure group

Light grey, similar to RAL 7035; special colours on request

Protection class

Depending on the model: IP 65 or IP 66/DIN EN 60529

Enclosure material

Enclosure material: ABS, PC (UV stabilised) and selected sizes in PC UL 94 V0 (additional UL 94 V0 versions on request), seal made of CR; for details, see Technical Information

Scope of delivery: Lid and base, lid screws made of V2A, self-tapping screws for mounting bosses

Note: * = Available on request. Accessories: see following pages.

G = Design with crystal-clear lid.

c3 = Ingress protection acc. to DIN EN 60529

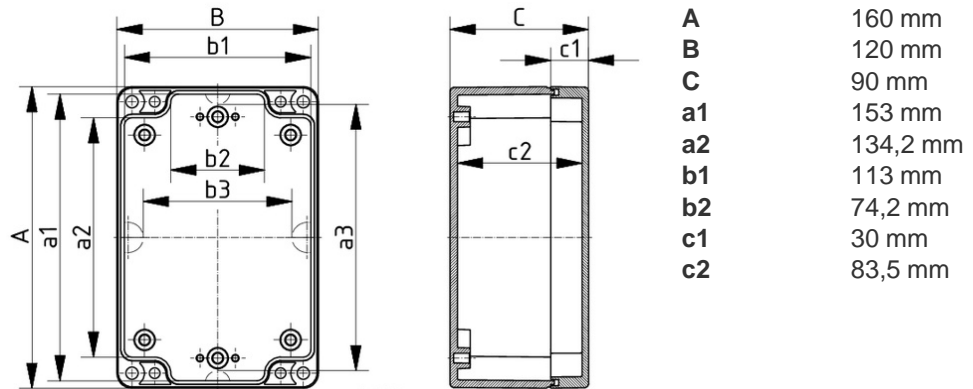

Technical drawings

Catalogue drawing in DXF format:

[02238000_M-238.dxf](#) (678 KB)

Catalogue drawing in PDF format:

[02238000_M-238.pdf](#) (72 KB)

3D product data in STEP format:

[Registration necessary](#)

Basic drawing for processing work:

[02238000_M-238-G.dxf](#) (325 KB)

Chapter download

[Euromas-ABS_Polycarbonate_GB.pdf](#) (531 KB)