



Model Number

GLV18-8-400-S/25/102/159

Energetic diffuse mode sensor
Plastic connector M12 x 1, 3-pin

Features

- Short design in M18 plastic housing
- Optical face lateral
- 4 LEDs indicator for 360° all-round visibility
- Optimal price/power ratio

Dimensions

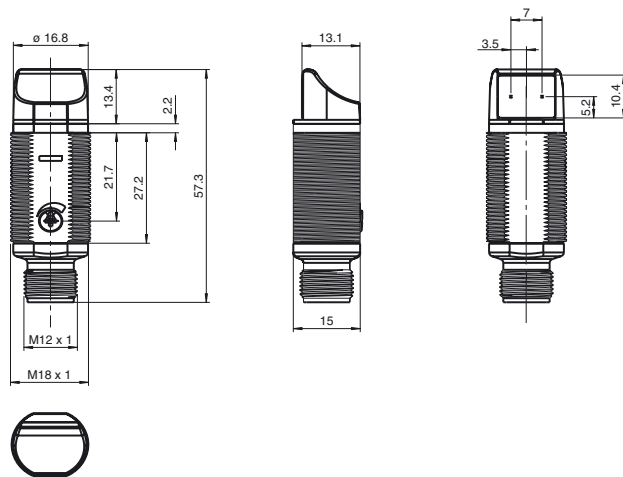

Electrical connection

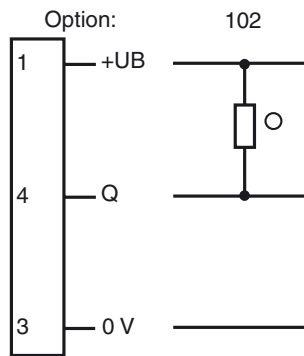

○ = Light on
● = Dark on

Pinning according

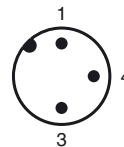

Technical data**General specifications**

Detection range	50 ... 400 mm adjustable
Detection range max.	0 ... 400 mm
Light source	LED, red 640 nm
Approvals	CE, cULus Listed 57M3 (Only in association with UL Class 2 power supply)
Reference target	100 mm x 100 mm Kodak white
Light type	red, modulated light
Diameter of the light spot	approx. 30 mm at 400 mm
Angle of divergence	approx. 4 °
Optical face	lateral
Ambient light limit	30000 Lux
Hysteresis	H < 15 %

Indicators/operating means

Operating display	green LED, statically lit Power on
Function display	LED yellow: lights when object is detected ; flashes when falling short of the stability control
Operating elements	sensitivity adjuster

Electrical specifications

Operating voltage	10 ... 30 V DC
Protection class	II, rated insulation voltage \dot{U} 250 V AC with degree of pollution 1-2 according to IEC 60664-1
No-load supply current	I_0 < 20 mA

Output

Switching type	light ON
Signal output	1 npn, short-circuit proof, open collector
Switching voltage	max. 30 V DC
Switching current	max. 100 mA
Voltage drop	$U_d \leq 1.5$ V DC
Switching frequency	f 500 Hz
Response time	≤ 1 ms

Standard conformity

Standards	EN 60947-5-2
-----------	--------------

Ambient conditions

Ambient temperature	-25 ... 60 °C (248 ... 333 K)
Storage temperature	-40 ... 70 °C (233 ... 343 K)

Mechanical specifications

Protection degree	IP67
Connection	Plastic connector M12 x 1 ; 3-pin
Material	
Housing	PC
Optical face	PMMA
Mass	< 10 g

