



ENGLISH

Datasheet

Stock No: 686-109

RS Pro Black Phenolic Knob, M6 x 30



Standards
BS771

Product Details

Phenolic Star Wheels

Black gloss star knobs made from phenolic, available with zinc plated male studs, brass threaded insert or through hole type with brass insert. Resistant to most industrial chemicals and ultra-violet. -30°C to + 140°C working range.

Specifications:

Thread	M6 x 30
Thread Diameter	M6
Thread Length	30mm
Knob Shape	Multiple Lobes
Mounting Type	Threaded Stud
Knob Diameter	32mm
Body Material	Phenolic
Insert Material	Steel
Colour	Black

Dimensions:

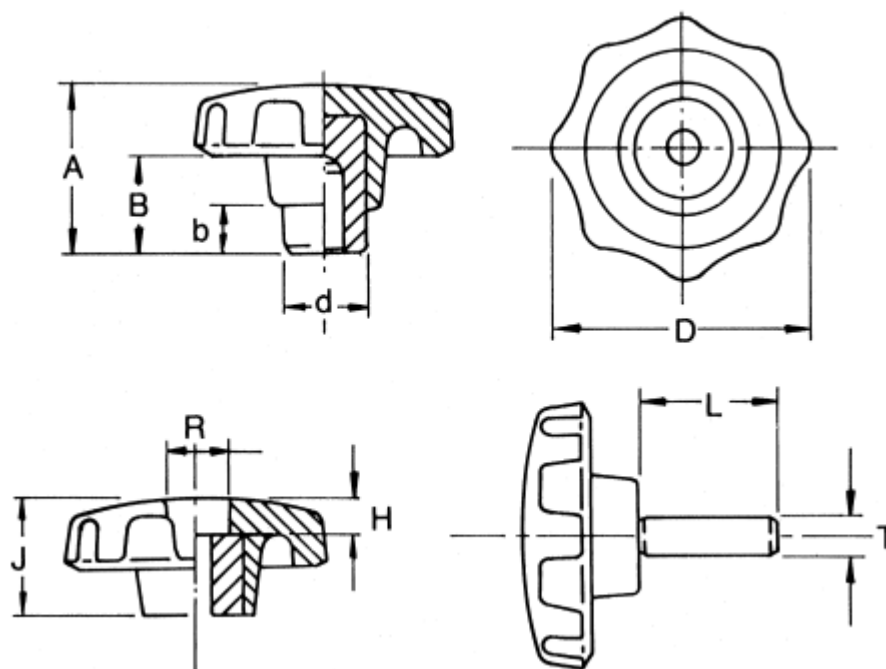

Dimensions (mm)					
T x L	Type/Insert	D	A	d1	B
M6 x 15	Male/Steel	32	27	12	17
M6 x 30	Male/Steel	32	27	12	17
M8 x 20	Male/Steel	44	29	14	16
M8 x 30	Male/Steel	44	29	14	16
M10 x 20	Male/Steel	57	38	19	22
M10 x 30	Male/Steel	57	38	19	22
M5 x 7.5	Female/Brass	32	27	12	17
M6 x 9	Female/Brass	32	27	12	17
M8 x 12	Female/Brass	44	29	14	16
M10 x 15	Female/Brass	44	29	14	16
M6 x 9	Through/Brass	32	27	12	17