

# Compression Fittings

**Brass Compression Fittings**

**Stainless Steel Compression Fittings**

**PL Nickel-Plated Brass Spigot Fittings**



**PARKER LEGRIS** Industrial Connector Systems

Products are available from

**MARYLAND METRICS**

P.O. Box 261 Owings Mills, MD 21117 USA email: sales@mdmetric.com

ph: (410)358-3130 (800)638-1830 fx: (410)358-3142 (800)872-9329

web: http://mdmetric.com RFQ form: http://mdmetric.com/rfq.htm

How to order: Please preface each PARKER LEGRIS Catalog part number with 'R053-' Example: R053-3175 04 10

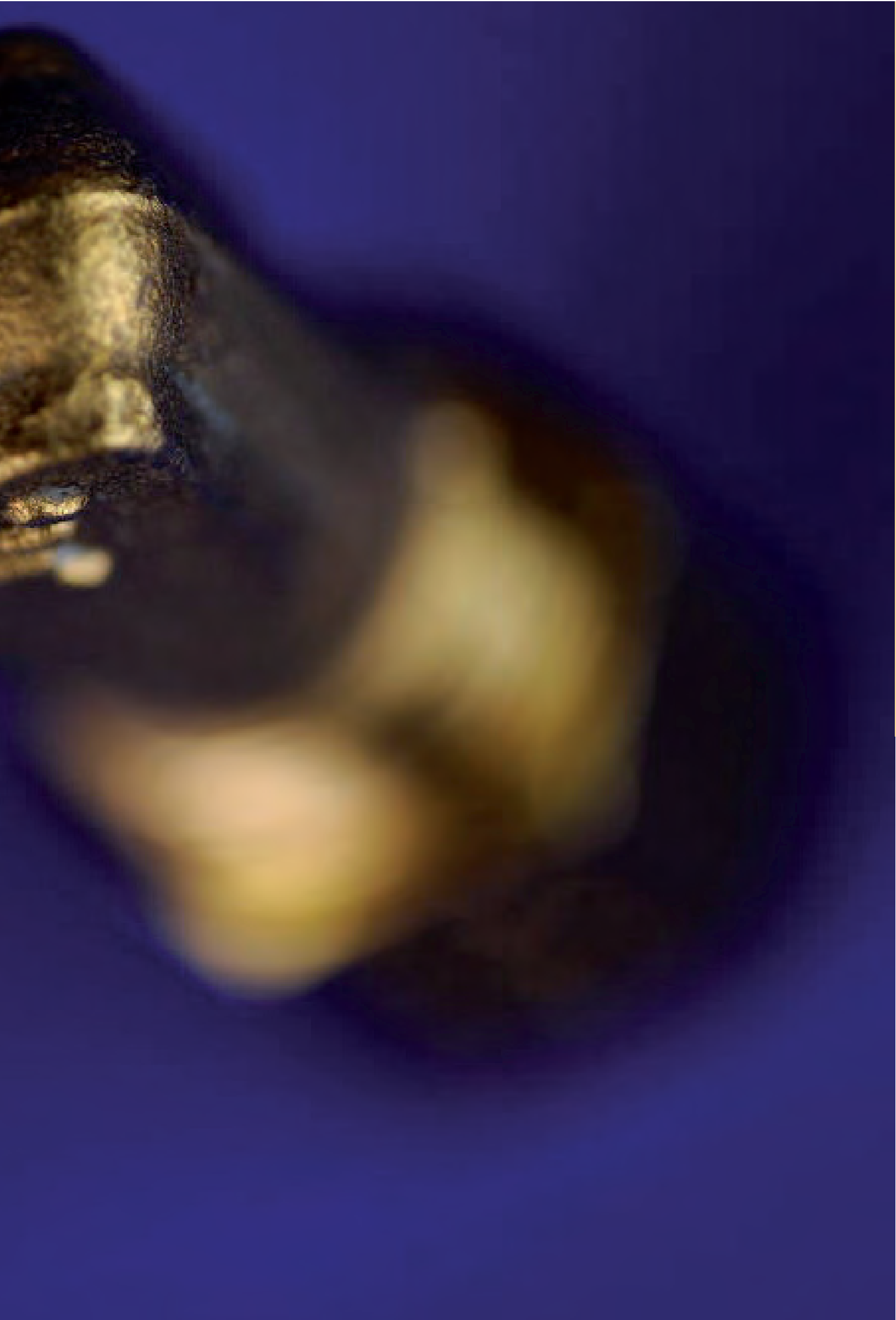

# Compression Fittings

## Brass Compression Fittings (P. 5-5)



**Fluids:** compressed air, non-corrosive industrial fluids  
**Materials:** forged or machined brass  
**Pressure:** 550 bar  
**Temperature:** -40°C to +250°C  
**Ø metric:** 4 mm to 28 mm

## Stainless Steel Compression Fittings (P. 5-31)



**Fluids:** compressed air, coolants, industrial and corrosive fluids  
**Materials:** 316L stainless steel  
**Pressure:** 400 bar  
**Temperature:** -40°C to +250°C  
**Ø metric:** 6 mm to 16 mm

## PL Nickel-Plated Brass Spigot Fittings (P. 5-41)



**Fluids:** compressed air, compatible industrial fluids  
**Materials:** forged or machined nickel-plated brass  
**Pressure:** 40 bar  
**Temperature:** -40°C to +100°C  
**Ø metric:** 4 mm to 14 mm

## Compression Fitting Part Numbers

# 0105 14 27 99

Item Type	Ø	Thread	Suffix
01XX: brass 18XX: stainless steel	04 = 4 mm 06 = 6 mm ... 20 = 20 mm 28 = 28 mm	10 = 1/8 13 = 1/4 ... 21 = 1/2 27 = 3/4	39: bonded seal 40: treated steel 60: nut 70: polymer nut 99: chemical nickel

## PL Fitting Part Numbers

# F3BPL 8/10 -1/4

Item Type	Ø	Thread
FBPL F3BPL HBPL WBPL ...	2.7/4 4/6 6/8 7.5/10 8/10 10/12 11/14	BSPT & NPT: 1/8 1/4 3/8 ... Metric: M10 M12

# Brass Compression Fitting Range

## Brass Fittings

### Stud Fittings

- |                                 |                                |   |                                      |                                    |                                  |                                  |                                 |
|---------------------------------|--------------------------------|---|--------------------------------------|------------------------------------|----------------------------------|----------------------------------|---------------------------------|
| <b>0105</b><br>BSPT<br>Page 5-9 | <b>0105</b><br>NPT<br>Page 5-9 | <b>0101</b><br>BSPP/Metric<br>Page 5-10 | <b>0101..39</b><br>BSPP<br>Page 5-10 | <b>0101</b><br>Metric<br>Page 5-11 | <b>0114</b><br>BSPP<br>Page 5-11 | <b>0109</b><br>BSPT<br>Page 5-12 | <b>0109</b><br>NPT<br>Page 5-12 |
|---------------------------------|--------------------------------|---|--------------------------------------|------------------------------------|----------------------------------|----------------------------------|---------------------------------|



- |                                  |                                  |                                  |                                  |                                      |                                  |                                      |
|----------------------------------|----------------------------------|----------------------------------|----------------------------------|--------------------------------------|----------------------------------|--------------------------------------|
| <b>0199</b><br>BSPP<br>Page 5-12 | <b>0108</b><br>BSPT<br>Page 5-13 | <b>0103</b><br>BSPT<br>Page 5-13 | <b>0118</b><br>BSPP<br>Page 5-14 | <b>0118..39</b><br>BSPP<br>Page 5-14 | <b>0119</b><br>BSPP<br>Page 5-15 | <b>0119..39</b><br>BSPP<br>Page 5-15 |
|----------------------------------|----------------------------------|----------------------------------|----------------------------------|--------------------------------------|----------------------------------|--------------------------------------|



### Tube-to-Tube Fittings

- |                          |                          |                          |                          |                          |                          |                          |
|--------------------------|--------------------------|--------------------------|--------------------------|--------------------------|--------------------------|--------------------------|
| <b>0106</b><br>Page 5-15 | <b>0113</b><br>Page 5-16 | <b>0116</b><br>Page 5-16 | <b>0102</b><br>Page 5-16 | <b>0104</b><br>Page 5-17 | <b>0142</b><br>Page 5-17 | <b>0107</b><br>Page 5-17 |
|--------------------------|--------------------------|--------------------------|--------------------------|--------------------------|--------------------------|--------------------------|



### Complementary Fittings

- |                          |                          |                              |                          |                          |                              |                              |                              |
|--------------------------|--------------------------|------------------------------|--------------------------|--------------------------|------------------------------|------------------------------|------------------------------|
| <b>0166</b><br>Page 5-20 | <b>0124</b><br>Page 5-21 | <b>0124..40</b><br>Page 5-21 | <b>0111</b><br>Page 5-21 | <b>0110</b><br>Page 5-22 | <b>0110..40</b><br>Page 5-22 | <b>0110..60</b><br>Page 5-22 | <b>0110..70</b><br>Page 5-22 |
|--------------------------|--------------------------|------------------------------|--------------------------|--------------------------|------------------------------|------------------------------|------------------------------|



## Self-Fastening Hose Barb Connectors

- |                          |                              |                          |
|--------------------------|------------------------------|--------------------------|
| <b>0132</b><br>Page 5-25 | <b>0133..39</b><br>Page 5-25 | <b>0134</b><br>Page 5-25 |
|--------------------------|------------------------------|--------------------------|



## Accessories

- |                          |                          |                          |                          |                          |                              |                          |                          |                              |                              |                              |
|--------------------------|--------------------------|--------------------------|--------------------------|--------------------------|------------------------------|--------------------------|--------------------------|------------------------------|------------------------------|------------------------------|
| <b>0122</b><br>Page 5-26 | <b>0165</b><br>Page 5-26 | <b>0126</b><br>Page 5-27 | <b>0125</b><br>Page 5-27 | <b>0220</b><br>Page 5-27 | <b>0220..39</b><br>Page 5-27 | <b>0120</b><br>Page 5-28 | <b>0112</b><br>Page 5-28 | <b>0128..39</b><br>Page 5-29 | <b>0151..39</b><br>Page 5-29 | <b>0168..39</b><br>Page 5-29 |
|--------------------------|--------------------------|--------------------------|--------------------------|--------------------------|------------------------------|--------------------------|--------------------------|------------------------------|------------------------------|------------------------------|



- |                          |
|--------------------------|
| <b>0127</b><br>Page 5-30 |
|--------------------------|



# Brass Compression Fittings

These **"universal"** fittings provide users with **numerous connection** options for a wide variety of tube materials without the need for tube threading or soldering. This range **guarantees** excellent long-term sealing and performance.

## Product Advantages

### Simple to Install and Use

- Suitable for pneumatic and medium pressure hydraulic applications
- Compatible with many industrial fluids
- Large product range: 22 configurations
- Excellent sealing due to the tightening of the olive onto the tube
- Metallic sealing guarantees maximum service life
- High strength brass for increased mechanical reliability

### Wide Variety of Tubing

- Connection of different types of tubing and hose: metal, polymer, steel, rubber, etc.
- Multiple tube diameters can be connected using the Parker Legris reducer assembly system
- No insert required for rigid and semi-rigid polyamide tubing below 14 mm



- Applications**
- Pneumatics
  - Cooling
  - Automotive Process
  - Lubrication
  - Fluid Transmission
  - Packaging
  - Industrial Machinery

## Technical Characteristics

<b>Compatible Fluids</b>	Water, machining oil, fuel, hydraulic oil, compressed air, chemical fluids, disinfectants
<b>Working Pressure</b>	Vacuum to 550 bar
<b>Working Temperature</b>	-40°C to +250°C
<b>Tightening Torque</b>	See "Technical Characteristics" on opposite page

Reliable performance is dependent upon the type of fluid conveyed, component materials and tubing being used.  
Guaranteed for use with a vacuum of 755 mm Hg (99% vacuum).

### Component Materials

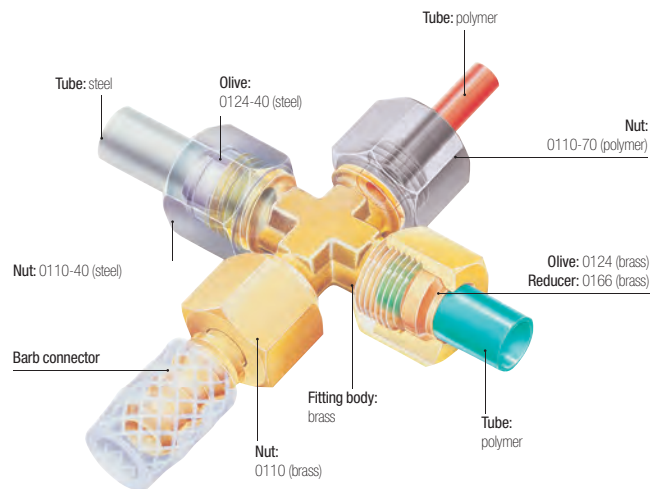

### Silicone-free

### Maximum Bore Diameters

The table below shows the recommended compatibility of tube size, BSPP male thread and maximum bore.

Tube O.D.	BSPP Thread	Max. Bore
4-5-6	G1/8	4
6-8-10	G1/4	7
10-12-14	G3/8	11
14-15-16-18	G1/2	14
18-20-22	G3/4	18
22-25-28	G1	24

### Tube Length for Assembly

Minimum length of tube (L) between 2 fittings.







ØD	L (mm)	ØD	L (mm)	ØD	L (mm)
4	26.5	12	39	20	51
5	26	14	41	22	54
6	26	15	41	25	62
8	32	16	46.5	28	62
10	39	18	49.5		

### Regulations

- CNOMO:** E07.21.115N (for robotic equipment in the automotive industry)
- DI:** 97/23/EC (PED)
- RG:** 1907/2006 (REACH)
- DI:** 2002/95/EC (RoHS)
- DI:** 94/9/EC (ATEX)

# Technical Characteristics

## Installing Compression Fittings

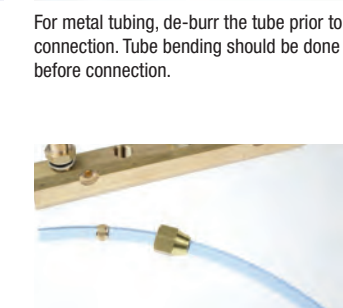
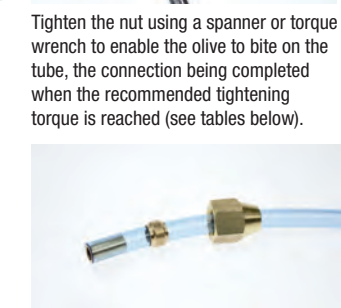
Cutting the Tube	Preparing the Connection	Connecting the Tube	Final Assembly
 <p>Cut the polymer or metal tube square.</p>	 <p>For metal tubing, de-burr the tube prior to connection. Tube bending should be done before connection.</p>	 <p>Push the tube up against the shoulder of the body of the fitting and hand tighten.</p>	 <p>Tighten the nut using a spanner or torque wrench to enable the olive to bite on the tube, the connection being completed when the recommended tightening torque is reached (see tables below).</p>
	 <p>Slide the nut onto the tube; lubricate the threads on the body and nut along with the olive to facilitate tightening (for metal tubing as well). Fit the olive onto the end of the tube.</p>		 <p>It is recommended to use an insert in order to prevent tube creeping (diameter &gt; 14mm)</p>

## Recommended Nut Tightening Torque

**Tightening torque in daN.m =**  
 maximum tightening torque of a 0110 nut and 0124 olive with copper, brass or steel tube.

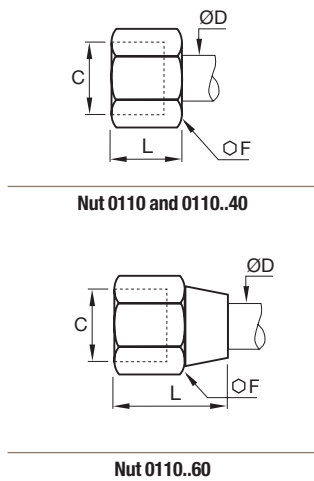

Ø D (mm)	Ø F 0110	Ø F 0110..60	Max. daN.m Copper or Brass	Ø F 0110..40	Max. daN.m Steel
4	10	11	0.7	10	1.5
5	12	13	0.7	12	1.5
6	13	13	1.5	13	2.5
8	14	16	1.5	14	2.5
10	19	20	1.8	19	3
12	22	22	3	22	4.5
14	24	24	3.5	24	5.5
15	24	24	4	24	6
16	27	27	5	27	7
18	30	30	6	30	9
20	32	32	6	32	10
22	36	36	7	36	12
25	41	41	8	41	13
28	42		9		

## Customised Fittings

Working directly with its customers and based on its knowledge and experience, Parker Legris can design customised brass compression fittings for specific requirements using the customer's specifications.

The range of compression fittings also offers nickel chemical surface treatment in order to improve the corrosion resistance and chemical compatibility of the fittings (the model number of the fitting is then given the suffix 99).

The above recommendations are given in good faith. However, since each application is different, it is advisable to undertake tests in actual working conditions.



# Technical Characteristics

The use of Parker Legris brass compression fittings is dependant on the tube material. Tables of recommended working pressure for the different tubes are shown below.

## Recommended Tube Type

**Copper tube:** copper which has been "cold rolled", cold drawn and in straight lengths.  
**Brass tube:** in cold-rolled straight lengths (same working pressure as for copper tube).  
**"Coiled annealed" copper tube:** reduces working pressure by 35%; must be avoided completely if vibration is present.

**Steel tube:** "thin wall" cold drawn, seamless, bright annealed and in straight lengths.  
 6 mm to 16 mm O.D.: max. wall thickness 1 mm  
 Above 16 mm O.D.: max. wall thickness 1.5 mm

**Polyamide tube:** semi-rigid  
 For rigid polyamide tube, multiply the figures in this table by 1.8.

## Recommended Tube-Fitting Assembly Configurations

Assembled using Parker Legris brass olive and nut.

Assembled using Parker Legris steel olive and nut (nut type 0110..40).

Assembled using Parker Legris brass olive and nut.

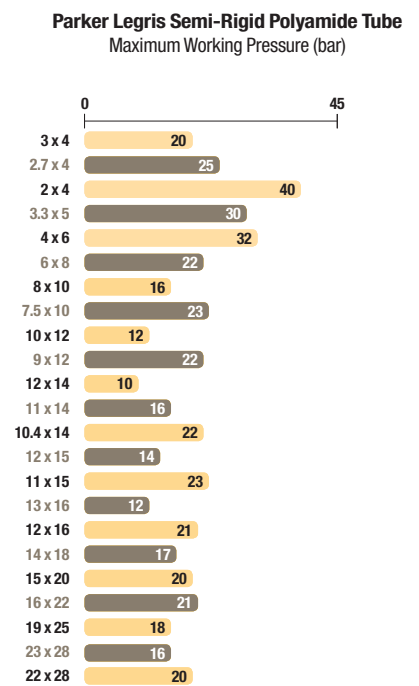
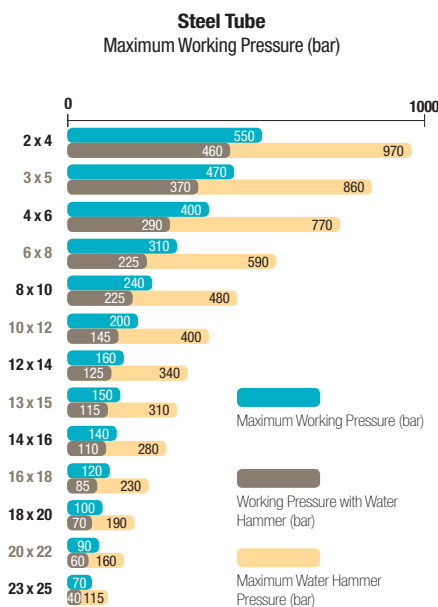
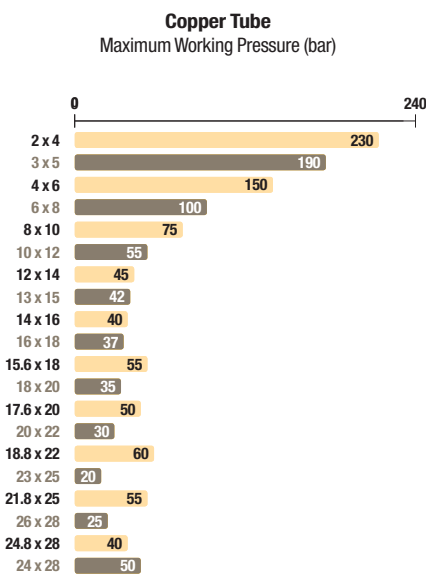

When using a plastic nut type 0110..70, the maximum working pressure is 10 bar, for all diameters.

## Working Pressure Coefficients for Semi-Rigid Polyamide Tubing

Temperature °C	-40°C / -15°C	-15°C / +30°C	+30°C / +50°C	+50°C / +70°C	+70°C / +100°C
Factor	1.8	1	0.68	0.55	0.31

Parker Legris brass compression fittings are not compatible with ammonia and its derivatives.

The above recommendations are given in good faith. However, since each application is different, it is advisable to undertake tests in actual working conditions.

# Brass Compression Fittings

## 0105 Stud Fitting, Male BSPT Thread

ØD	C		F	F1	H <sub>max</sub>	H1	kg
			Brass				
4	R1/8	<a href="#">0105 04 10</a>	10	10	17	7	0.012
	R1/8	<a href="#">0105 05 10</a>	11	12	17.5	7.5	0.016
5	R1/4	<a href="#">0105 05 13</a>	14	12	17.5	7.5	0.022
	R1/8	<a href="#">0105 06 10</a>	11	13	18	7.5	0.017
6	R1/4	<a href="#">0105 06 13</a>	14	13	18	7.5	0.024
	R3/8	<a href="#">0105 06 17</a>	17	13	18	8.5	0.031
8	R1/8	<a href="#">0105 08 10</a>	13	14	19.5	7	0.020
	R1/4	<a href="#">0105 08 13</a>	14	14	19.5	7	0.025
10	R3/8	<a href="#">0105 08 17</a>	17	14	20.5	8	0.032
	R1/8	<a href="#">0105 10 10</a>	17	19	24	9	0.043
12	R1/4	<a href="#">0105 10 13</a>	17	19	24	9	0.047
	R3/8	<a href="#">0105 10 17</a>	17	19	24	9	0.048
14	R1/2	<a href="#">0105 10 21</a>	22	19	25	10	0.067
	R1/4	<a href="#">0105 12 13</a>	19	22	24	9	0.059
16	R3/8	<a href="#">0105 12 17</a>	19	22	24	9	0.060
	R1/2	<a href="#">0105 12 21</a>	22	22	25	10	0.076
18	R1/4	<a href="#">0105 14 13</a>	22	24	25	8	0.068
	R3/8	<a href="#">0105 14 17</a>	22	24	25	8	0.068
20	R1/2	<a href="#">0105 14 21</a>	22	24	26	9	0.080
	R3/4	<a href="#">0105 14 27</a>	27	24	27	10	0.107
22	R3/8	<a href="#">0105 15 17</a>	22	24	25	8	0.065
	R1/2	<a href="#">0105 15 21</a>	22	24	26	9	0.076
24	R1/4	<a href="#">0105 16 13</a>	24	27	27	9.5	0.092
	R3/8	<a href="#">0105 16 17</a>	24	27	27	9.5	0.092
26	R1/2	<a href="#">0105 16 21</a>	24	27	27	9.5	0.099
	R3/4	<a href="#">0105 16 27</a>	27	27	28	10.5	0.123
28	R1/2	<a href="#">0105 18 21</a>	27	30	30	10.5	0.127
	R3/4	<a href="#">0105 18 27</a>	27	30	30	10.5	0.138
30	R1/2	<a href="#">0105 20 21</a>	30	32	32	11	0.148
	R3/4	<a href="#">0105 20 27</a>	30	32	32	11	0.157
32	R1/2	<a href="#">0105 22 21</a>	32	36	33	11	0.187
	R3/4	<a href="#">0105 22 27</a>	32	36	33	11	0.196
34	R1	<a href="#">0105 22 34</a>	36	36	33	11	0.227
	R3/4	<a href="#">0105 25 27</a>	36	41	36	11	0.261
36	R1	<a href="#">0105 25 34</a>	36	41	36	11	0.278
	R3/4	<a href="#">0105 28 27</a>	41	42	36	11	0.274
38	R1	<a href="#">0105 28 34</a>	41	42	36	11	0.283

Metric taper threads or Briggs (NPT threads) are available by special order, subject to minimum quantities.

Brass Compression Fittings

Compression Fittings

## 0105 Stud Fitting, Male NPT Thread

ØD	C		F	F1	H <sub>max</sub>	H1	kg
			Brass				
6	NPT1/8	<a href="#">0105 06 11</a>	11	13	18	7.5	0.018
	NPT1/4	<a href="#">0105 06 14</a>	14	13	18	7.5	0.027
8	NPT1/8	<a href="#">0105 08 11</a>	13	14	21	7	0.021
	NPT1/4	<a href="#">0105 08 14</a>	14	14	18.5	7	0.026
10	NPT1/4	<a href="#">0105 10 14</a>	17	19	24	9	0.048
	NPT3/8	<a href="#">0105 10 18</a>	17	19	24	9	0.048
12	NPT1/2	<a href="#">0105 10 22</a>	22	19	25	10	0.066

# Brass Compression Fittings

## 0101 Stud Fitting with Captive Sealing Washer, Male BSPP and Metric Thread



Brass, technical polymer

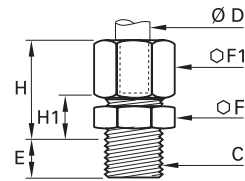

ØD	C		E	F	F1	H <sub>max</sub>	H1	kg
4	M5x0.8	<a href="#">0101 04 19</a>	5	10	10	16.5	8	0.011
	G1/8	<a href="#">0101 04 10</a>	6.5	13	10	16.5	8	0.016
5	G1/8	<a href="#">0101 05 10</a>	6.5	13	12	17.5	8.5	0.018
	G1/8	<a href="#">0101 06 10</a>	6.5	13	13	18	8.5	0.020
6	G1/4	<a href="#">0101 06 13</a>	8	17	13	18	9.5	0.030
	G1/8	<a href="#">0101 08 10</a>	6.5	13	14	19	8.5	0.021
8	G1/4	<a href="#">0101 08 13</a>	8	17	14	19.5	9	0.032
	G3/8	<a href="#">0101 08 17</a>	11	22	14	20	10.5	0.044
10	G1/4	<a href="#">0101 10 13</a>	8	17	19	24	11	0.049
	G3/8	<a href="#">0101 10 17</a>	11	22	19	24	11.5	0.061
12	G1/4	<a href="#">0101 12 13</a>	8	19	22	24	11	0.062
	G3/8	<a href="#">0101 12 17</a>	11	22	22	24	11.5	0.069
14	G1/2	<a href="#">0101 12 21</a>	12	27	22	24	12	0.089
	G3/8	<a href="#">0101 14 17</a>	11	22	24	25	10.5	0.074
15	G1/2	<a href="#">0101 14 21</a>	12	27	24	25	11	0.094
	G3/8	<a href="#">0101 15 17</a>	11	22	24	25	10.5	0.071
16	G1/2	<a href="#">0101 15 21</a>	12	27	24	25	11	0.093
	G3/8	<a href="#">0101 16 17</a>	11	22	27	27	12	0.092
18	G1/2	<a href="#">0101 16 21</a>	12	27	27	27	12.5	0.109
	G3/4	<a href="#">0101 18 21</a>	12	27	30	29.5	12.5	0.128
20	G3/4	<a href="#">0101 18 27</a>	13	32	30	29.5	13	0.152
	G3/4	<a href="#">0101 20 27</a>	13	32	32	31	13	0.164
22	G3/4	<a href="#">0101 22 27</a>	13	32	36	32	13	0.195
	G1	<a href="#">0101 22 34</a>	15	41	36	31	13.5	0.259
25	G3/4	<a href="#">0101 25 27</a>	13	36	41	35.5	13	0.261
	G1	<a href="#">0101 25 34</a>	15	41	41	35.5	13	0.169
28	G1	<a href="#">0101 28 34</a>	15	41	42	35.5	13.5	0.300

With pre-assembled captive sealing washer  
Sealing washers 0602 are shown in Chapter 9.

## 0101..39 Stud Fitting, with Bi-Material Seal, Male BSPP



Brass, zinc-plated steel with NBR seal

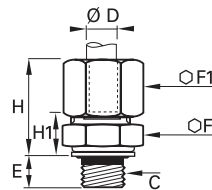

ØD	C		E	F	F1	H <sub>max</sub>	H1	kg
4	G1/8	<a href="#">0101 04 10 39</a>	5.5	13	10	17.5	9	0.016
5	G1/8	<a href="#">0101 05 10 39</a>	5.5	13	12	18.5	9.5	0.019
	G1/8	<a href="#">0101 06 10 39</a>	5.5	13	13	19	9.5	0.020
6	G1/4	<a href="#">0101 06 13 39</a>	7	17	13	19	10.5	0.030
	G1/8	<a href="#">0101 08 10 39</a>	5.5	13	14	20	9.5	0.022
8	G1/4	<a href="#">0101 08 13 39</a>	7	17	14	20.5	10	0.032
	G3/8	<a href="#">0101 08 17 39</a>	9.5	22	14	21.5	12	0.045
10	G1/4	<a href="#">0101 10 13 39</a>	7	17	19	25	12	0.048
	G3/8	<a href="#">0101 10 17 39</a>	9.5	22	19	25.5	13	0.062
12	G1/4	<a href="#">0101 12 13 39</a>	7	19	22	25	12	0.063
	G3/8	<a href="#">0101 12 17 39</a>	9.5	22	22	25	13	0.071
14	G1/2	<a href="#">0101 12 21 39</a>	10.5	27	22	25	13.5	0.091
	G3/8	<a href="#">0101 14 17 39</a>	9.5	22	24	26.5	12	0.075
15	G1/2	<a href="#">0101 14 21 39</a>	10.5	27	24	26.5	12.5	0.095
	G3/8	<a href="#">0101 15 17 39</a>	9.5	22	24	26.5	12	0.073
16	G1/2	<a href="#">0101 15 21 39</a>	10.5	27	24	26.5	12.5	0.095
	G3/8	<a href="#">0101 16 17 39</a>	9.5	22	27	28.5	13.5	0.092
18	G1/2	<a href="#">0101 16 21 39</a>	10.5	27	27	28.5	14	0.111
	G1/2	<a href="#">0101 18 21 39</a>	10.5	27	30	31	14	0.129
20	G3/4	<a href="#">0101 18 27 39</a>	11.5	32	30	31	14.5	0.155
	G3/4	<a href="#">0101 20 27 39</a>	11.5	32	32	32.5	14.5	0.164
22	G3/4	<a href="#">0101 22 27 39</a>	11.5	32	36	32.5	14.5	0.197
	G1	<a href="#">0101 22 34 39</a>	13	41	36	33	15.5	0.259
25	G1	<a href="#">0101 25 34 39</a>	13	41	41	37.5	15.5	0.309
28	G1	<a href="#">0101 28 34 39</a>	13	41	42	37.5	15.5	0.301

Thread with bi-material seal  
Bi-material sealing washers, part number 0139, can be found in Chapter 9

# Brass Compression Fittings

## 0101 Stud Fitting, Male Metric Thread



ØD	C	[Icon]	E	F	F1	H max	H1	kg
4	M7x1	<a href="#">0101 04 55</a>	6.5	10	10	16.5	7.5	0.012
	M8x1	<a href="#">0101 04 56</a>	6.5	11	10	16.5	7.5	0.013
5	M8x1	<a href="#">0101 05 56</a>	6.5	11	12	17.5	8	0.016
	M10x1	<a href="#">0101 05 60</a>	6.5	14	12	17.5	8.5	0.020
6	M10x1	<a href="#">0101 06 60</a>	6.5	14	13	18	8.5	0.021
	M10x1.5	<a href="#">0101 06 62</a>	6.5	14	13	18	8.5	0.021
8	M12x1	<a href="#">0101 08 65</a>	8	17	14	19.5	9	0.029
	M12x1.25	<a href="#">0101 08 66</a>	8	17	14	19.5	9	0.029
10	M14x1.25	<a href="#">0101 10 70</a>	8	17	19	24	11	0.047
	M14x1.5	<a href="#">0101 10 71</a>	8	17	19	24	11	0.047
12	M16x1.25	<a href="#">0101 10 74</a>	9	19	19	24	11	0.051
	M16x1.5	<a href="#">0101 10 75</a>	9	19	19	24	11	0.051
14	M18x1.5	<a href="#">0101 10 78</a>	9	22	19	24	11.5	0.060
	M16x1.25	<a href="#">0101 12 74</a>	9	19	22	24	11	0.061
16	M16x1.5	<a href="#">0101 12 75</a>	9	19	22	24	11	0.061
	M18x1.5	<a href="#">0101 12 78</a>	9	22	22	24	11.5	0.070
18	M18x1.5	<a href="#">0101 14 78</a>	9	22	24	25	10.5	0.077
	M20x1.5	<a href="#">0101 14 80</a>	10	24	24	25	11	0.084
15	M18x1.5	<a href="#">0101 15 78</a>	9	22	24	25	10.5	0.071
	M20x1.5	<a href="#">0101 16 80</a>	10	24	27	27	12.5	0.102
16	M22x1.5	<a href="#">0101 16 82</a>	10	27	27	27	12.5	0.111
	M22x1.5	<a href="#">0101 18 82</a>	10	27	30	29.5	12.5	0.129
18	M24x1.5	<a href="#">0101 18 83</a>	11	30	30	29.5	13	0.142

## 0114 Stud Fitting, Female BSPP Thread

ØD	C	[Icon]	E	F	F1	H max	H1	kg
4	G1/8	<a href="#">0114 04 10</a>	9.5	14	10	26	16.5	0.020
	G1/4	<a href="#">0114 04 13</a>	13.5	17	10	30	20.5	0.030
5	G1/8	<a href="#">0114 05 10</a>	9.5	14	12	28	17	0.023
	G1/4	<a href="#">0114 05 13</a>	13.5	17	12	31	21	0.033
6	G1/8	<a href="#">0114 06 10</a>	9.5	14	13	28	17	0.025
	G1/4	<a href="#">0114 06 13</a>	13.5	17	13	32	21	0.034
8	G3/8	<a href="#">0114 06 17</a>	14	22	13	32	21.5	0.051
	G1/8	<a href="#">0114 08 10</a>	9.5	14	14	29	16.5	0.026
10	G1/4	<a href="#">0114 08 13</a>	13.5	17	14	33	20.5	0.036
	G3/8	<a href="#">0114 08 17</a>	14	22	14	34	21	0.052
12	G1/4	<a href="#">0114 10 13</a>	13.5	17	19	37	21.5	0.052
	G3/8	<a href="#">0114 10 17</a>	14	22	19	37	22	0.068
14	G1/2	<a href="#">0114 10 21</a>	18.5	27	19	42	26.5	0.099
	G1/4	<a href="#">0114 12 13</a>	13.5	19	22	36	20.5	0.069
16	G3/8	<a href="#">0114 12 17</a>	14	22	22	37	22	0.078
	G1/2	<a href="#">0114 12 21</a>	18.5	27	22	42	26.5	0.109
18	G1/4	<a href="#">0114 14 13</a>	13.5	22	24	36	18.5	0.085
	G3/8	<a href="#">0114 14 17</a>	14	22	24	38	21	0.048
20	G1/2	<a href="#">0114 14 21</a>	18.5	27	24	43	25.5	0.113
	G3/8	<a href="#">0114 15 17</a>	14	22	24	38	21	0.078
22	G1/2	<a href="#">0114 15 21</a>	18.5	27	24	43	25.5	0.109
	G1/4	<a href="#">0114 16 13</a>	13.5	24	27	36	18	0.107
24	G3/8	<a href="#">0114 16 17</a>	14	24	27	38	20.5	0.106
	G1/2	<a href="#">0114 16 21</a>	18.5	27	27	44	26	0.127
26	G3/8	<a href="#">0114 18 17</a>	14	27	30	39	19.5	0.140
	G1/2	<a href="#">0114 18 21</a>	18.5	27	30	45	26	0.144
28	G3/4	<a href="#">0114 18 27</a>	19.5	32	30	46	27	0.165
	G3/8	<a href="#">0114 20 17</a>	14	30	32	38	18	0.161
30	G1/2	<a href="#">0114 20 21</a>	18.5	30	32	44.5	24	0.173
	G3/4	<a href="#">0114 20 27</a>	19.5	32	32	47	26.5	0.170
32	G3/4	<a href="#">0114 22 27</a>	19.5	32	36	48	26.5	0.204
	G3/4	<a href="#">0114 25 27</a>	19.5	36	41	50.5	26	0.297

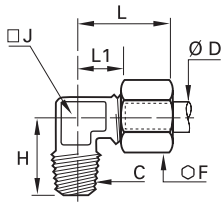

# Brass Compression Fittings

## 0109 Stud Elbow, Male BSPT Thread

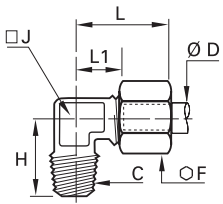

	Brass		ØD	C		F	H	J	L <sub>max</sub>	L1	kg
			4	R1/8	<a href="#">0109 04 10</a>	10	17	8	19	9.5	0.016
				R1/4	<a href="#">0109 04 13</a>	10	20	10	19	11	0.026
			5	R1/8	<a href="#">0109 05 10</a>	12	17.5	8	21	11	0.019
				R1/4	<a href="#">0109 05 13</a>	12	21.5	10	22	12	0.028
			6	R1/8	<a href="#">0109 06 10</a>	13	18	8	22	11	0.021
				R1/4	<a href="#">0109 06 13</a>	13	21.5	10	22	12	0.031
				R1/8	<a href="#">0109 08 10</a>	14	18.5	10	28	15	0.028
			8	R1/4	<a href="#">0109 08 13</a>	14	22	10	28	15	0.033
				R3/8	<a href="#">0109 08 17</a>	14	24	12	28	15	0.044
				R1/4	<a href="#">0109 10 13</a>	19	25	12	30	14.5	0.052
			10	R3/8	<a href="#">0109 10 17</a>	19	25.5	12	30	14.5	0.060
				R1/2	<a href="#">0109 10 21</a>	19	32	19	36	21	0.109
				R1/4	<a href="#">0109 12 13</a>	22	26	15	30	15	0.074
			12	R3/8	<a href="#">0109 12 17</a>	22	27	15	30	15	0.077
				R1/2	<a href="#">0109 12 21</a>	22	32	19	36	21	0.116
				R3/8	<a href="#">0109 14 17</a>	24	30	19	35	18	0.105
			14	R1/2	<a href="#">0109 14 21</a>	24	32	19	35	18	0.112
				R3/8	<a href="#">0109 15 17</a>	24	30	19	35	18	0.099
				R1/2	<a href="#">0109 15 21</a>	24	32	19	35	18	0.106
				R3/8	<a href="#">0109 16 17</a>	27	30	19	39	21	0.120
			16	R1/2	<a href="#">0109 16 21</a>	27	33.5	19	39	21	0.130
				R3/4	<a href="#">0109 16 27</a>	27	36.5	23	41	23	0.189
				R1/2	<a href="#">0109 18 21</a>	30	35.5	23	41	21.5	0.182
			18	R3/4	<a href="#">0109 18 27</a>	30	36.5	23	41	21.5	0.199
				R1/2	<a href="#">0109 20 21</a>	32	36.5	23	42	21.5	0.181
			20	R3/4	<a href="#">0109 20 27</a>	32	38	23	42	21.5	0.200
				R3/4	<a href="#">0109 22 27</a>	36	40	27	50	30	0.288
			22	R1	<a href="#">0109 22 34</a>	36	44	27	50	30	0.342
				R3/4	<a href="#">0109 25 27</a>	41	43	27	54	30	0.325
			25	R1	<a href="#">0109 25 34</a>	41	44	27	54	30	0.367
				R3/4	<a href="#">0109 28 27</a>	42	46	32	54	30	0.402
			28	R1	<a href="#">0109 28 34</a>	42	48	32	54	30	0.384

Metric taper threads or Briggs (NPT threads) are available by special order, subject to minimum quantities.

## 0109 Stud Elbow, Male NPT Thread

	Brass		ØD	C		F	H	J	L <sub>max</sub>	L1	kg
			6	NPT1/8	<a href="#">0109 06 11</a>	13	18	8	22	11	0.021
				NPT1/4	<a href="#">0109 06 14</a>	13	21.5	10	22	12	0.030
			8	NPT1/8	<a href="#">0109 08 11</a>	14	18.5	10	28	15	0.028
				NPT1/4	<a href="#">0109 08 14</a>	14	22	10	28	15	0.033
			10	NPT1/4	<a href="#">0109 10 14</a>	19	25	12	30	14.5	0.053

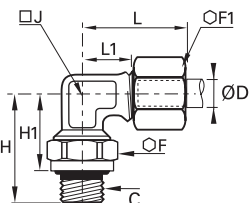
## 0199 Stud Orientable Elbow, Male BSPP Thread

	Brass, NBR		ØD	C		F	F1	H	H1	H1 <sub>max</sub>	J	L <sub>max</sub>	L1	kg
			4	G1/8	<a href="#">0199 04 10</a>	14	10	23	16	17	8	19	9.5	0.023
				G1/4	<a href="#">0199 04 13</a>	19	10	30.5	22	23.5	10	19	11	0.043
			6	G1/8	<a href="#">0199 06 10</a>	14	13	23	16	17	8	22	11	0.027
				G1/4	<a href="#">0199 06 13</a>	19	13	30.5	22	23.5	10	22	12	0.047
				G1/8	<a href="#">0199 08 10</a>	14	14	24	17	18	10	28	15	0.033
			8	G1/4	<a href="#">0199 08 13</a>	19	14	30.5	22	23.5	10	28	15	0.051
				G3/8	<a href="#">0199 08 17</a>	22	14	33.5	24	25.5	12	28	15	0.065
				G1/4	<a href="#">0199 10 13</a>	19	19	31	22.5	24	12	30	14.5	0.068
			10	G3/8	<a href="#">0199 10 17</a>	22	19	33.5	24	25.5	12	30	14.5	0.079
				G1/2	<a href="#">0199 10 21</a>	27	19	40	29.5	31	19	37	22	0.138
				G3/8	<a href="#">0199 14 17</a>	22	24	35.5	26	27.5	19	35	18	0.119
			14	G1/2	<a href="#">0199 14 21</a>	27	24	40	29.5	31	19	35	18	0.141
				G1/2	<a href="#">0199 18 21</a>	27	30	40	29	30.5	23	41	21.5	0.187
				G3/4	<a href="#">0199 18 27</a>	32	30	43.5	32	33.5	23	41	21.5	0.222
			22	G3/4	<a href="#">0199 22 27</a>	32	36	45.5	34	36	32	51	31	0.382
				G1	<a href="#">0199 22 34</a>	41	36	54	40.5	43	32	51	31	0.408
			28	G1	<a href="#">0199 28 34</a>	41	42	54	40.5	43	32	54	30	0.420

The body will orientate for positioning purposes

# Brass Compression Fittings

## 0108 Stud Branch Tee, Male BSPT Thread

Brass		ØD	C		F	H	J	L1	L/2	kg
4	R1/8	0108 04 10	10	17	8	9.5	19			0.025
	R1/8	0108 05 10	12	17.5	8	11	21			0.017
6	R1/8	0108 06 10	13	18	8	11	22			0.032
	R1/4	0108 06 13	13	21.5	10	16	27			0.047
8	R1/8	0108 08 10	14	18.5	10	15	28			0.045
	R1/4	0108 08 13	14	22	10	15	28			0.050
	R3/8	0108 08 17	14	24	12	15	28			0.061
10	R1/4	0108 10 13	19	25	12	14.5	30			0.084
	R3/8	0108 10 17	19	25.5	12	14.5	30			0.090
12	R1/4	0108 12 13	22	26	15	15	30			0.116
	R3/8	0108 12 17	22	27	15	15	30			0.117
14	R3/8	0108 14 17	24	30	19	18	35			0.153
	R1/2	0108 14 21	24	32	19	18	35			0.168
15	R3/8	0108 15 17	24	30	19	18	35			0.145
	R1/2	0108 15 21	24	32	19	18	35			0.155
16	R3/8	0108 16 17	27	30	19	21	39			0.190
	R1/2	0108 16 21	27	33.5	19	21	39			0.203
18	R1/2	0108 18 21	30	35.5	23	21.5	41			0.265
	R3/4	0108 18 27	30	36.5	23	21.5	41			0.292
20	R3/4	0108 20 27	32	38	23	21.5	42			0.298
	R3/4	0108 22 27	36	40	27	29	50			0.435
22	R3/4	0108 22 27	36	40	27	29	50			0.435
	R1	0108 22 34	36	44	27	29	50			0.466

Metric taper threads or Briggs (NPT threads) are available by special order, subject to minimum quantities.



## 0103 Stud Run Tee, Male BSPT Thread

Brass		ØD	C		F	H <sub>max</sub>	H1	H2	J	kg
4	R1/8	0103 04 10	10	19	17	9.5	8			0.025
	R1/8	0103 05 10	12	21	17.5	11	8			0.030
6	R1/8	0103 06 10	13	22	18	11	8			0.033
	R1/4	0103 06 13	13	27	21.5	16	10			0.048
8	R1/8	0103 08 10	14	28	18.5	15	10			0.045
	R1/4	0103 08 13	14	28	22	15	10			0.050
10	R3/8	0103 08 17	14	28	24	15	12			0.061
	R1/4	0103 10 13	19	30	25	14.5	12			0.084
12	R3/8	0103 10 17	19	30	25.5	14.5	12			0.092
	R1/4	0103 12 13	22	30	26	15	15			0.114
14	R3/8	0103 12 17	22	30	27	15	15			0.120
	R3/8	0103 14 17	24	35	30	18	19			0.161
15	R1/2	0103 14 21	24	35	32	18	19			0.169
	R3/8	0103 15 17	24	35	30	18	19			0.148
16	R1/2	0103 15 21	24	35	32	18	19			0.158
	R3/8	0103 16 17	27	39	30	21	19			0.192
18	R1/2	0103 16 21	27	39	33.5	21	19			0.199
	R1/2	0103 18 21	30	41	35.5	21.5	23			0.269
20	R3/4	0103 18 27	30	41	36.5	21.5	23			0.282
	R3/4	0103 20 27	32	42	38	21.5	23			0.298
22	R3/4	0103 20 27	36	50	40	29	27			0.435
	R3/4	0103 22 27	36	50	40	29	27			0.435

Metric taper threads or Briggs (NPT threads) are available by special order, subject to minimum quantities.

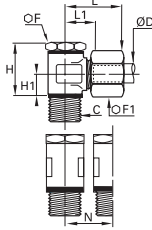

# Brass Compression Fittings

## 0118 Single Banjo, with Captive Sealing Washer, Male BSPP Thread

	Brass, technical polymer  	<b>ØD</b>	<b>C</b>		<b>F</b>	<b>F1</b>	<b>H</b>	<b>H1</b>	<b>L<sub>max</sub></b>	<b>L1</b>	<b>N</b>	<b>kg</b>
		4	G1/8	<a href="#">0118 04 10</a>	14	10	24	9.5	24	14.5	17.5	0.038
		5	G1/8	<a href="#">0118 05 10</a>	14	12	24	9.5	25	14.5	17.5	0.041
			G1/4	<a href="#">0118 05 13</a>	17	12	25	10	26	16	21	0.058
		6	G1/8	<a href="#">0118 06 10</a>	14	13	24	9.5	25	14.5	17.5	0.041
			G1/4	<a href="#">0118 06 13</a>	17	13	25	10	26	16	21	0.056
		8	G1/8	<a href="#">0118 08 10</a>	14	14	24	9.5	28	15.5	17.5	0.054
			G1/4	<a href="#">0118 08 13</a>	17	14	25	10	28	15.5	21	0.057
			G3/8	<a href="#">0118 08 17</a>	22	14	32	13	30	18	26.5	0.111
		10	G1/4	<a href="#">0118 10 13</a>	17	19	31	13	34	19	23	0.120
			G3/8	<a href="#">0118 10 17</a>	22	19	32	13	34	19	26.5	0.129
		12	G1/4	<a href="#">0118 12 13</a>	17	22	34	14.5	34	19	23	0.126
			G3/8	<a href="#">0118 12 17</a>	22	22	35	14.5	34	19	26.5	0.133
		14	G1/4	<a href="#">0118 14 13</a>	17	24	37	16	37	20.5	28	0.154
			G3/8	<a href="#">0118 14 17</a>	22	24	38	16	37	20.5	28	0.195
		15	G1/2	<a href="#">0118 14 21</a>	27	24	40	16	38	20.5	32.5	0.208
			G3/8	<a href="#">0118 15 17</a>	22	24	38	16	37	20.5	28	0.190
		16	G1/2	<a href="#">0118 15 21</a>	27	24	40	16	38	20.5	32.5	0.198
		18	G1/2	<a href="#">0118 16 21</a>	27	27	42	16	38	21	32.5	0.221
		20	G3/4	<a href="#">0118 18 21</a>	27	30	46	19.5	43	24.5	36	0.366
		22	G3/4	<a href="#">0118 20 27</a>	32	32	49	20	44	24.5	39	0.403
				<a href="#">0118 22 27</a>	32	36	53	22	45	24.5	39	0.459

With pre-assembled captive sealing washer  
Sealing washers 0602 can be found in Chapter 9.

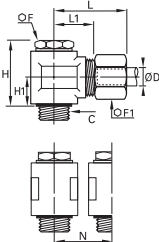
## 0118..39 Single Banjo with Bi-Material Seal, Male BSPP Thread

	Brass, zinc-plated steel with NBR seal  	<b>ØD</b>	<b>C</b>		<b>F</b>	<b>F1</b>	<b>H</b>	<b>H1</b>	<b>L<sub>max</sub></b>	<b>L1</b>	<b>N</b>	<b>kg</b>
		4	G1/8	<a href="#">0118 04 10 39</a>	14	10	23	9.5	24	14.5	17.5	0.038
		5	G1/8	<a href="#">0118 05 10 39</a>	14	12	23	9.5	25	14.5	17.5	0.041
			G1/4	<a href="#">0118 05 13 39</a>	17	12	24	10	26	16	21	0.064
		6	G1/8	<a href="#">0118 06 10 39</a>	14	13	23	9.5	25	14.5	17.5	0.042
			G1/4	<a href="#">0118 06 13 39</a>	17	13	24	10	26	16	21	0.057
		8	G1/8	<a href="#">0118 08 10 39</a>	14	14	23	9.5	28	15.5	17.5	0.055
			G1/4	<a href="#">0118 08 13 39</a>	17	14	24	10	28	15.5	21	0.058
			G3/8	<a href="#">0118 08 17 39</a>	22	14	31.5	13.5	30	18	26.5	0.113
		10	G1/4	<a href="#">0118 10 13 39</a>	17	19	30	13	34	19	23	0.118
			G3/8	<a href="#">0118 10 17 39</a>	22	19	31.5	13.5	34	19	26.5	0.128
		12	G1/4	<a href="#">0118 12 13 39</a>	17	22	33	14.5	34	19	23	0.128
			G3/8	<a href="#">0118 12 17 39</a>	22	22	34.5	15	34	19	26.5	0.140
		14	G1/4	<a href="#">0118 14 13 39</a>	17	24	36	16	37	20.5	28	0.189
			G3/8	<a href="#">0118 14 17 39</a>	22	24	37.5	16.5	37	20.5	28	0.198
		15	G1/2	<a href="#">0118 14 21 39</a>	27	24	39	16.5	38	20.5	32.5	0.205
			G3/8	<a href="#">0118 15 17 39</a>	22	24	37.5	16.5	37	20.5	28	0.389
		16	G1/2	<a href="#">0118 15 21 39</a>	27	24	40	16.5	38	20.5	32.5	0.202
		18	G1/2	<a href="#">0118 16 21 39</a>	27	27	40	16.5	38	21	32.5	0.225
		20	G3/4	<a href="#">0118 18 21 39</a>	27	30	47	20	43	24.5	36	0.369
		22	G3/4	<a href="#">0118 20 27 39</a>	32	32	50	20.5	44	24.5	39	0.394
				<a href="#">0118 22 27 39</a>	32	36	54	22.5	45	24.5	39	0.462

With bi-material sealing washer  
Bi-material sealing washers, part number 0139, can be found in Chapter 9.

# Brass Compression Fittings

## 0119 Double Banjo with Captive Sealing Washer, Male BSPP Thread



Brass, technical polymer

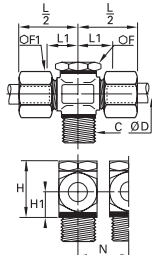

ØD	C		F	F1	H	H1	L1	L/2	N	kg
4	G1/8	<a href="#">0119 04 10</a>	14	10	24	9.5	14.5	24	17.5	0.049
6	G1/8	<a href="#">0119 06 10</a>	14	13	24	9.5	14.5	25	17.5	0.056
	G1/4	<a href="#">0119 06 13</a>	17	13	25	10	16	26.5	21	0.038
8	G1/8	<a href="#">0119 08 10</a>	14	14	24	9.5	15.5	28	17.5	0.069
	G3/8	<a href="#">0119 08 17</a>	17	14	25	10	15.5	28	21	0.074
10	G1/4	<a href="#">0119 10 13</a>	17	19	31	13	19	34	23	0.156
	G3/8	<a href="#">0119 10 17</a>	22	19	32	13	19	34	26.5	0.165
12	G1/4	<a href="#">0119 12 13</a>	17	22	34	14.5	19	34	23	0.180
	G3/8	<a href="#">0119 12 17</a>	22	22	35	14.5	19	34	26.5	0.182
14	G1/4	<a href="#">0119 14 13</a>	17	24	37	16	20.5	37.5	28	0.246
	G3/8	<a href="#">0119 14 17</a>	22	24	38	16	20.5	37.5	28	0.247
	G1/2	<a href="#">0119 14 21</a>	27	24	40	16	20.5	38	32.5	0.219

Thread with pre-assembled washer  
Sealing washers 0602 can be found in Chapter 9.

## 0119..39 Double Banjo with Bi-Material Seal, Male BSPP Thread



Brass, zinc-plated steel with NBR seal

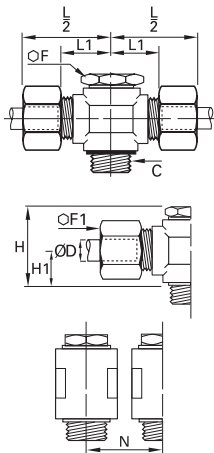

ØD	C		F	F1	H	H1	L1	L/2	N	kg
4	G1/8	<a href="#">0119 04 10 39</a>	14	10	23	9.5	14.5	24	17.5	0.050
5	G1/8	<a href="#">0119 05 10 39</a>	14	12	23	9.5	14.5	25	17.5	0.049
	G1/4	<a href="#">0119 05 13 39</a>	17	12	24	10	126	26	21	0.072
6	G1/8	<a href="#">0119 06 10 39</a>	14	13	23	9.5	14.5	25	17.5	0.056
	G1/4	<a href="#">0119 06 13 39</a>	17	13	24	10	16	26	21	0.071
8	G1/8	<a href="#">0119 08 10 39</a>	14	14	23	9.5	15.5	28	17.5	0.072
	G1/4	<a href="#">0119 08 13 39</a>	17	14	24	10	15.5	28	21	0.080
10	G3/8	<a href="#">0119 08 17 39</a>	22	14	31.5	13.5	18	30	26.5	0.118
	G1/4	<a href="#">0119 10 13 39</a>	17	19	30	13	19	34	23	0.156
12	G3/8	<a href="#">0119 10 17 39</a>	22	19	31.5	13.5	19	34	26.5	0.167
	G1/4	<a href="#">0119 12 13 39</a>	17	22	33	14.5	19	34	23	0.180
14	G3/8	<a href="#">0119 12 17 39</a>	22	22	34.5	15	19	34	26.5	0.183
	G1/4	<a href="#">0119 14 13 39</a>	17	24	36	16	20.5	37	28	0.248
15	G3/8	<a href="#">0119 14 17 39</a>	22	24	37.5	16.5	20.5	37	28	0.247
	G1/2	<a href="#">0119 14 21 39</a>	27	24	39	16.5	20.5	38	32.5	0.262
18	G3/8	<a href="#">0119 15 17 39</a>	22	24	37.5	16.5	20.5	37	28	0.246
	G1/2	<a href="#">0119 15 21 39</a>	27	24	40	16.5	20.5	38	32.5	0.251
20	G1/2	<a href="#">0119 18 21 39</a>	27	30	47	20	24.5	43	36	0.469
22	G3/4	<a href="#">0119 20 27 39</a>	32	32	50	20.5	24.5	44	39	0.638
	G3/4	<a href="#">0119 22 27 39</a>	32	36	54	22.5	24.5	45	39	0.610

Thread with pre-assembled washer  
Bi-material sealing washers, part number 0139, can be found in Chapter 9.

## 0106 Equal Tube-to-Tube Connector



Brass

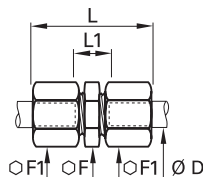

ØD		F	F1	L <sub>max</sub>	L1	kg
4	<a href="#">0106 04 00</a>	10	10	28	10	0.016
5	<a href="#">0106 05 00</a>	11	12	31	11	0.023
6	<a href="#">0106 06 00</a>	11	13	32	11	0.026
8	<a href="#">0106 08 00</a>	13	14	36	10	0.031
10	<a href="#">0106 10 00</a>	17	19	42	13	0.070
12	<a href="#">0106 12 00</a>	19	22	42	13	0.092
14	<a href="#">0106 14 00</a>	22	24	45	11	0.104
15	<a href="#">0106 15 00</a>	22	24	45	11	0.097
16	<a href="#">0106 16 00</a>	24	27	48	13	0.141
18	<a href="#">0106 18 00</a>	27	30	53	14	0.186
20	<a href="#">0106 20 00</a>	30	32	56	14	0.211
22	<a href="#">0106 22 00</a>	32	36	60	14	0.283
25	<a href="#">0106 25 00</a>	36	41	64	14	0.396
28	<a href="#">0106 28 00</a>	41	42	64	14	0.399

# Brass Compression Fittings

## 0113 Equal Tube-to-Tube Connector with Mounting Boss

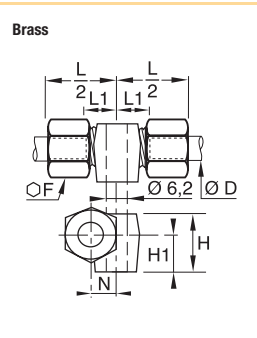

ØD		F	H	H1	L1	L/2	N	kg
4	<a href="#">0113 04 00</a>	10	10.5	7	9.5	19	6	0.022
6	<a href="#">0113 06 00</a>	13	13	9	10	20.5	7	0.033
8	<a href="#">0113 08 00</a>	14	14.5	9.5	11	23.5	8	0.041
10	<a href="#">0113 10 00</a>	19	19.5	12.5	11	26	9	0.082
12	<a href="#">0113 12 00</a>	22	22	14	12	26.5	11	0.107
14	<a href="#">0113 14 00</a>	24	25	16	11	28	12	0.122

## 0116 Equal Bulkhead Connector

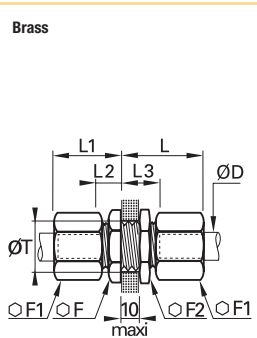

ØD		F	F1	F2	L max	L1 max	L2	L3	ØT min	kg
4	<a href="#">0116 04 00</a>	10	10	13	27	17	7	17	8.3	0.024
5	<a href="#">0116 05 00</a>	13	12	14	28	18	7.5	17.5	10.3	0.035
6	<a href="#">0116 06 00</a>	13	13	14	28	19	7.5	17.5	10.3	0.037
8	<a href="#">0116 08 00</a>	14	14	17	29	20	7	17	12.3	0.045
10	<a href="#">0116 10 00</a>	19	19	22	33	25	9	19	16.5	0.101
12	<a href="#">0116 12 00</a>	22	22	22	33	25	9	19	18.5	0.121
14	<a href="#">0116 14 00</a>	24	24	24	35	25	8	18	20.5	0.145
15	<a href="#">0116 15 00</a>	24	24	24	35	25	8	18	20.5	0.134
16	<a href="#">0116 16 00</a>	27	27	27	36	28	9.5	19.5	22.5	0.189
18	<a href="#">0116 18 00</a>	27	30	30	40	30	10.5	20.5	24.5	0.237
20	<a href="#">0116 20 00</a>	32	30	32	41	31	11	21	27.5	0.274
22	<a href="#">0116 22 00</a>	36	36	36	42	32	11	21	30.5	0.372
25	<a href="#">0116 25 00</a>	36	41	38	46	36	11	21	33.5	0.469

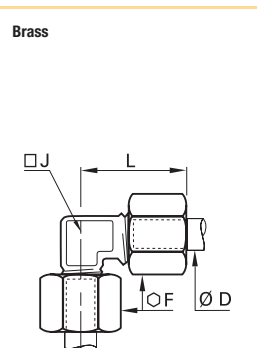

## 0102 Equal Elbow



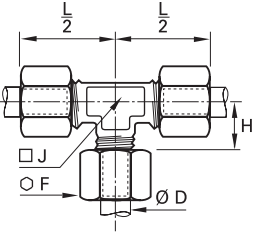

ØD		F	J	L max	kg
4	<a href="#">0102 04 00</a>	10	5	19	0.016
5	<a href="#">0102 05 00</a>	12	8	21	0.024
6	<a href="#">0102 06 00</a>	13	8	22	0.027
8	<a href="#">0102 08 00</a>	14	10	28	0.038
10	<a href="#">0102 10 00</a>	19	12	30	0.073
12	<a href="#">0102 12 00</a>	22	15	30	0.098
14	<a href="#">0102 14 00</a>	24	19	35	0.133
15	<a href="#">0102 15 00</a>	24	19	35	0.122
16	<a href="#">0102 16 00</a>	27	19	39	0.164
18	<a href="#">0102 18 00</a>	30	23	41	0.231
20	<a href="#">0102 20 00</a>	32	23	42	0.233
22	<a href="#">0102 22 00</a>	36	27	50	0.371
25	<a href="#">0102 25 00</a>	41	27	54	0.446
28	<a href="#">0102 28 00</a>	42	32	54.5	0.478

# Brass Compression Fittings

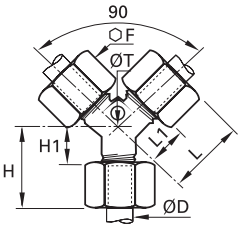

## 0104 Equal Tee

		<b>ØD</b>		<b>F</b>	<b>H</b>	<b>J</b>	<b>L/2</b>	<b>kg</b>
		4	<a href="#">0104 04 00</a>	10	9.5	8	19	0.028
		5	<a href="#">0104 05 00</a>	12	11	8	21	0.036
		6	<a href="#">0104 06 00</a>	13	11	8	22	0.040
		8	<a href="#">0104 08 00</a>	14	15	10	28	0.055
		10	<a href="#">0104 10 00</a>	19	14.5	12	30	0.105
		12	<a href="#">0104 12 00</a>	22	15	15	30	0.142
		14	<a href="#">0104 14 00</a>	24	18	19	35	0.190
		15	<a href="#">0104 15 00</a>	24	18	19	35	0.175
		16	<a href="#">0104 16 00</a>	27	21	19	39	0.239
		18	<a href="#">0104 18 00</a>	30	21.5	23	41	0.330
		20	<a href="#">0104 20 00</a>	32	21.5	23	42	0.330
		22	<a href="#">0104 22 00</a>	36	29	27	50	0.518
		25	<a href="#">0104 25 00</a>	41	29	27	54	0.630
		28	<a href="#">0104 28 00</a>	42	30	32	55	0.660

## 0142 Equal Y Piece with Mounting Boss

		<b>ØD</b>		<b>F</b>	<b>H max</b>	<b>H1</b>	<b>L max</b>	<b>L1</b>	<b>ØT</b>	<b>Kg</b>
		4	<a href="#">0142 04 00</a>	10	16.5	7	26.5	17	4.2	0.032
		6	<a href="#">0142 06 00</a>	13	19.5	8.5	28	17	4.2	0.049
		8	<a href="#">0142 08 00</a>	14	21	8	30	17	6.2	0.061
		10	<a href="#">0142 10 00</a>	19	24.5	9	37.5	22	6.2	0.128
		12	<a href="#">0142 12 00</a>	22	26	11	38	23	6.2	0.110
		14	<a href="#">0142 14 00</a>	24	28	11	41.5	24.5	6.2	0.201
		15	<a href="#">0142 15 00</a>	24	28	11	41.5	24.5	6.2	0.204
		16	<a href="#">0142 16 00</a>	27	30	12	43	25	6.2	0.252
		18	<a href="#">0142 18 00</a>	30	31.5	12	50.5	31	10.2	0.220
		25	<a href="#">0142 25 00</a>	41	39	14	59	34	10.2	0.728

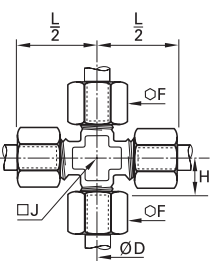
## 0107 Equal Cross

		<b>ØD</b>		<b>F</b>	<b>H</b>	<b>J</b>	<b>L/2</b>	<b>Kg</b>
		4	<a href="#">0107 04 00</a>	10	9.5	8	19	0.035
		5	<a href="#">0107 05 00</a>	12	11	8	21	0.047
		6	<a href="#">0107 06 00</a>	13	11	8	22	0.052
		8	<a href="#">0107 08 00</a>	14	15	11	28	0.073
		10	<a href="#">0107 10 00</a>	19	14.5	14	30	0.142
		12	<a href="#">0107 12 00</a>	22	15	15	35	0.096
		14	<a href="#">0107 14 00</a>	24	18	20	35	0.246
		15	<a href="#">0107 15 00</a>	24	18	20	35	0.227
		16	<a href="#">0107 16 00</a>	27	21	20	39	0.312
		18	<a href="#">0107 18 00</a>	30	21.5	25	41	0.426
		20	<a href="#">0107 20 00</a>	32	21.5	25	42	0.429
		22	<a href="#">0107 22 00</a>	36	29	27	50	0.676
		25	<a href="#">0107 25 00</a>	41	29	27	50	0.819

# Complementary Brass Fittings Reducers, Olives and Nuts

This innovative reducer system, using a full range of nuts and olives, enables **different diameters** of steel, copper, brass or polymer tubes to be fitted onto **a single Parker Legris compression fitting**.

## Product Advantages

### Efficient Solution

Reduces envelope dimensions  
Quick and easy to assemble, whatever the diameters and tube material  
Improved stock management  
Silicone-free

### Multiple Combinations

A single connector for up to 4 different tube materials and sizes  
Example:
 

- polymer tube 4 mm O.D.
- copper tube 8 mm O.D.
- brass tube 12 mm O.D.
- braided PVC hose 12 mm I.D.

 A full range of olives and nuts to optimise all assembly operations



**Applications**

Pneumatics  
Cooling  
Automotive Process  
Lubrication  
Fluid Transmission  
Packaging  
Industrial Machinery

### Regulations

DI: 97/23/EC (PED)  
RG: 1907/2006 (REACH)  
DI: 2002/95/EC (RoHS)  
DI: 94/9/EC (ATEX)

## Reducer Assembly Procedure

Operation	Assembly Sequence	Assembled Fitting
<p><b>1</b> <b>Assemble the reducer</b> Place the reducer in the fitting body.</p>	<p><b>1</b></p>	
<p><b>2</b> <b>Assemble the nut and olive</b> Place the nut and then the olive onto the tube.</p>	<p><b>2</b></p>	
<p><b>3</b> <b>Assemble the nut</b> Push the tubing into the fitting until it butts against the tube reducer. Tighten the nut to the recommended torque (see opposite page).</p>	<p><b>3</b></p>	

# Complementary Brass Fittings

## Assembly Configuration

The table and information given below illustrate the large number of options available with Parker Legris brass compression fittings. To these must be added the advantages specific to the original Parker Legris reducer shown on the previous page.



Brass Body

0110 Brass			0110..60 Brass		0110..40 Steel	0110..70* Polymer
	<b>0124 Brass</b>	<b>0111 BNA** Brass</b>	<b>0124 Brass</b>	<b>0111 BNA** Brass</b>	<b>0124...40 Steel</b>	
No olive required to assemble the plug						No olive required to assemble the tube
Brass plug: <b>0126</b>	Copper, cold-rolled brass, polymer tube and barb connectors <b>0122</b> and <b>0165</b>	Coiled annealed copper tube	Cold-rolled copper tube for vibration and side loading, etc.	Coiled annealed copper tube for vibration and side loading, etc.	Steel or copper tube: low/medium hydraulic pressure, lubricate before assembly	Polymer tube

**\*Assembly specifications for nut-olive 0110 ..70**

This part functions as both olive and nut for flexible polymer tube assemblies:

1. Hand tighten the polymer nut-olive a few turns onto the body of the fitting; the knurling makes this easier.
2. Then introduce the polymer tube and push home into the body of the fitting.
3. Continue manually tightening the polymer nut-olive.
4. Finish tightening using a spanner until the nut body disengages and turns freely, which acts as a torque limiter.

**N.B.:** To avoid damaging the threads, do not insert the tube before hand tightening the nut-olive into the body of the fitting.

\*\*Bureau de Normalisation de l'Automobile (French Automotive Bureau of Standards)

**Recommended Tightening Torque**

**Tightening torque in daN.m =**

maximum tightening torque of a **0110** nut and **0124** olive with copper, brass or steel tube.

Nut **0110** and **0110..40**

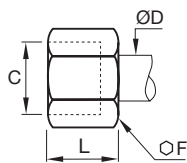

Nut **0110..60**

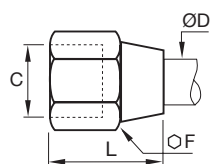

Ø D (mm)	OF 0110	OF 0110..60	max. daN.m copper or brass	OF 0110..40	max. daN.m steel
4	10	11	0.7	10	1.5
5	12	13	0.7	12	1.5
6	13	13	1.5	13	2.5
8	14	16	1.5	14	2.5
10	19	20	1.8	19	3
12	22	22	3	22	4.5
14	24	24	3.5	24	5.5
15	24	24	4	24	6
16	27	27	5	27	7
18	30	30	6	30	9
20	32	32	6	32	10
22	36	36	7	36	12
25	41	41	8	41	13
28	42		9		

# Complementary Brass Compression Fittings

## 0166 3-Piece Reducer





ØD1	ØD2		F	kg
4	5	0166 04 05	13	0.011
	6	0166 04 06	13	0.011
	8	0166 04 08	14	0.012
	10	0166 04 10	19	0.031
	12	0166 04 12	22	0.044
	14	0166 04 14	24	0.054
5	15	0166 04 15	24	0.056
	6	0166 05 06	13	0.010
	8	0166 05 08	14	0.012
	10	0166 05 10	19	0.030
	12	0166 05 12	22	0.044
	14	0166 05 14	24	0.053
6	16	0166 05 16	27	0.078
	8	0166 06 08	14	0.012
	10	0166 06 10	19	0.030
	12	0166 06 12	22	0.043
	14	0166 06 14	24	0.052
	15	0166 06 15	24	0.054
8	16	0166 06 16	27	0.077
	10	0166 08 10	19	0.027
	12	0166 08 12	22	0.040
	14	0166 08 14	24	0.051
	15	0166 08 15	24	0.053
	16	0166 08 16	27	0.076
10	18	0166 08 18	30	0.100
	12	0166 10 12	22	0.037
	14	0166 10 14	24	0.045
	15	0166 10 15	24	0.047
	16	0166 10 16	27	0.068
	18	0166 10 18	30	0.095
12	20	0166 10 20	32	0.107
	22	0166 10 22	36	0.144
	25	0166 10 25	41	0.209
	14	0166 12 14	24	0.043
	15	0166 12 15	24	0.043
	16	0166 12 16	27	0.066
14	18	0166 12 18	30	0.092
	20	0166 12 20	32	0.102
	22	0166 12 22	36	0.140
	25	0166 12 25	41	0.200
	16	0166 14 16	27	0.060
	18	0166 14 18	30	0.084
15	20	0166 14 20	32	0.095
	22	0166 14 22	36	0.133
	25	0166 14 25	41	0.189
	18	0166 15 18	30	0.081
16	22	0166 15 22	36	0.130
	18	0166 16 18	30	0.078
	20	0166 16 20	32	0.088
	22	0166 16 22	36	0.126
18	25	0166 16 25	41	0.185
	20	0166 18 20	32	0.082
	22	0166 18 22	36	0.118
	25	0166 18 25	41	0.180
20	28	0166 18 28	42	0.176
	25	0166 20 25	41	0.168
22	28	0166 22 28	42	0.168

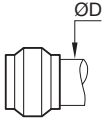

ØD1: tube to be fitted  
 ØD2: for an x mm Ø fitting  
 Each of the above part numbers comprises:  
 - a reduction piece  
 - an olive, PN 0124  
 - a sleeve nut

# Complementary Brass Compression Fittings

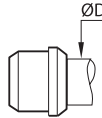

## 0124 Brass Olive

	Brass  	<b>ØD</b>		<b>kg</b>
		4	<a href="#">0124 04 00</a>	0.001
		5	<a href="#">0124 05 00</a>	0.001
		6	<a href="#">0124 06 00</a>	0.001
		8	<a href="#">0124 08 00</a>	0.001
		10	<a href="#">0124 10 00</a>	0.003
		12	<a href="#">0124 12 00</a>	0.004
		14	<a href="#">0124 14 00</a>	0.005
		15	<a href="#">0124 15 00</a>	0.004
		16	<a href="#">0124 16 00</a>	0.006
		18	<a href="#">0124 18 00</a>	0.007
		20	<a href="#">0124 20 00</a>	0.009
		22	<a href="#">0124 22 00</a>	0.012
		25	<a href="#">0124 25 00</a>	0.017
28	<a href="#">0124 28 00</a>	0.017		

## 0124..40 Steel Olive

	Zinc-plated steel  	<b>ØD</b>		<b>kg</b>
		4	<a href="#">0124 04 00 40</a>	0.001
		6	<a href="#">0124 06 00 40</a>	0.001
		8	<a href="#">0124 08 00 40</a>	0.001
		10	<a href="#">0124 10 00 40</a>	0.003
		12	<a href="#">0124 12 00 40</a>	0.003
		14	<a href="#">0124 14 00 40</a>	0.005
		15	<a href="#">0124 15 00 40</a>	0.004
		16	<a href="#">0124 16 00 40</a>	0.006
		18	<a href="#">0124 18 00 40</a>	0.007
		20	<a href="#">0124 20 00 40</a>	0.007
		22	<a href="#">0124 22 00 40</a>	0.010
		25	<a href="#">0124 25 00 40</a>	0.014

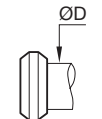

## 0111 BNA\* Brass Olive

	Brass  	<b>ØD</b>		<b>kg</b>
		4	<a href="#">0111 04 00</a>	0.001
		5	<a href="#">0111 05 00</a>	0.001
		6	<a href="#">0111 06 00</a>	0.001
		8	<a href="#">0111 08 00</a>	0.001
		10	<a href="#">0111 10 00</a>	0.002
		12	<a href="#">0111 12 00</a>	0.002
		14	<a href="#">0111 14 00</a>	0.003
		15	<a href="#">0111 15 00</a>	0.003
		16	<a href="#">0111 16 00</a>	0.003

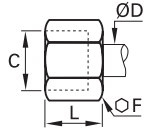

\*BNA: Bureau de Normalisation de l'Automobile (standards organization in the field of Automotive Process)

# Complementary Brass Compression Fittings

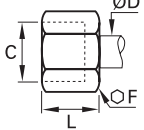

## 0110 Brass Nut

	Brass		<b>ØD</b>	<b>C</b>		<b>F</b>	<b>L</b>	<b>kg</b>
			4	M8x1	<a href="#">0110 04 00</a>	10	11	0.005
			5	M10x1	<a href="#">0110 05 00</a>	12	11	0.006
			6	M10x1	<a href="#">0110 06 00</a>	13	11	0.008
			8	M12x1	<a href="#">0110 08 00</a>	14	13	0.008
			10	M16x1.5	<a href="#">0110 10 00</a>	19	15	0.019
			12	M18x1.5	<a href="#">0110 12 00</a>	22	15	0.026
			14	M20x1.5	<a href="#">0110 14 00</a>	24	15	0.029
			15	M20x1.5	<a href="#">0110 15 00</a>	24	15	0.028
			16	M22x1.5	<a href="#">0110 16 00</a>	27	17	0.042
			18	M24x1.5	<a href="#">0110 18 00</a>	30	18	0.057
			20	M27x1.5	<a href="#">0110 20 00</a>	32	18	0.057
			22	M30x1.5	<a href="#">0110 22 00</a>	36	19	0.078
			25	M33x1.5	<a href="#">0110 25 00</a>	41	21	0.121
28	M36x1.5	<a href="#">0110 28 00</a>	42	21	0.110			

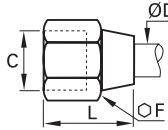

## 0110..40 Steel Nut

	Zinc-plated steel		<b>ØD</b>	<b>C</b>		<b>F</b>	<b>L</b>	<b>kg</b>
			4	M8x1	<a href="#">0110 04 00 40</a>	10	11	0.004
			5	M10x1	<a href="#">0110 05 00 40</a>	12	11.5	0.005
			6	M10x1	<a href="#">0110 06 00 40</a>	13	12	0.008
			8	M12x1	<a href="#">0110 08 00 40</a>	14	13.5	0.008
			10	M16x1.5	<a href="#">0110 10 00 40</a>	19	16	0.018
			12	M18x1.5	<a href="#">0110 12 00 40</a>	22	16.5	0.027
			14	M20x1.5	<a href="#">0110 14 00 40</a>	24	17	0.030
			15	M20x1.5	<a href="#">0110 15 00 40</a>	24	17	0.029
			16	M22x1.5	<a href="#">0110 16 00 40</a>	27	18	0.042
			18	M24x1.5	<a href="#">0110 18 00 40</a>	30	19	0.056
			20	M27x1.5	<a href="#">0110 20 00 40</a>	32	20.5	0.061
			22	M30x1.5	<a href="#">0110 22 00 40</a>	36	21.5	0.085

## 0110..60 Brass Long Nut

	Brass		<b>ØD</b>	<b>C</b>		<b>F</b>	<b>L</b>	<b>kg</b>
			4	M8x1	<a href="#">0110 04 00 60</a>	11	14.5	0.007
			5	M10x1	<a href="#">0110 05 00 60</a>	13	17	0.008
			6	M10x1	<a href="#">0110 06 00 60</a>	13	17.5	0.011
			8	M12x1	<a href="#">0110 08 00 60</a>	16	20	0.019
			10	M16x1.5	<a href="#">0110 10 00 60</a>	20	23	0.032
			12	M18x1.5	<a href="#">0110 12 00 60</a>	22	25	0.039
			14	M20x1.5	<a href="#">0110 14 00 60</a>	24	30	0.051
			15	M20x1.5	<a href="#">0110 15 00 60</a>	24	30	0.049
			16	M22x1.5	<a href="#">0110 16 00 60</a>	27	32	0.070
			18	M24x1.5	<a href="#">0110 18 00 60</a>	30	35	0.098
			20	M27x1.5	<a href="#">0110 20 00 60</a>	32	35	0.102
			22	M30x1.5	<a href="#">0110 22 00 60</a>	36	36	0.129

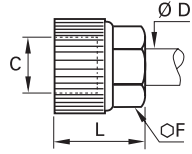
## 0110..70 Technical Polymer Nut-Olive

	Technical polymer		<b>ØD</b>	<b>C</b>		<b>F</b>	<b>L</b>	<b>kg</b>
			4	M8x1	<a href="#">0110 04 00 70</a>	8	13	0.008
			6	M10x1	<a href="#">0110 06 00 70</a>	11	15	0.002
			8	M12x1	<a href="#">0110 08 00 70</a>	13	16	0.002
			10	M16x1.5	<a href="#">0110 10 00 70</a>	17	19	0.004
			12	M18x1.5	<a href="#">0110 12 00 70</a>	19	19	0.005
			14	M20x1.5	<a href="#">0110 14 00 70</a>	22	20	0.005
16	M22x1.5	<a href="#">0110 16 00 70</a>	24	21	0.008			

NB: polymer nut-olives should not be used on metal tubing.



Brass Compression Fittings

Compression Fittings

# Self-Fastening Barb Connectors for NBR Hose

This range of fittings is designed to meet the requirements of the automotive and robotics industries, combining as it does **optimum CNOMO manufacturing quality**, simple installation, reliable operation and a **long service life**.

## Product Advantages

### Perfect for Self-Fastening NBR Hose

- Quick and simple to install
- Compatible with the Parker Legris range of brass compression fittings
- Mechanical properties proven for use in industrial robotic installations
- Spark-resistant

### Ergonomic and Time-Saving

- Fitting does not require lubrication or clamping, reducing assembly time
- Visual stop confirms installation is correct and improves operating safety
- Removal by cutting the tube
- The fitting can be re-used if necessary



**Applications**

Welding Robots  
Pneumatics  
Compressed Air Systems  
Automotive Process  
Cooling

## Technical Characteristics

<b>Compatible Fluids</b>	Coolants, compressed air
<b>Working Pressure</b>	0 to 16 bar
<b>Working Temperature</b>	0°C to +100°C (water) -20°C to +70°C (air)

<b>Tightening Torque, Type 0132</b>	DN	6	8	10	14	18	22
	daN.m	0.7	1.5	1.8	3.5	6	7

Reliable performance is dependent upon the type of fluid conveyed and hose being used.

### Component Materials

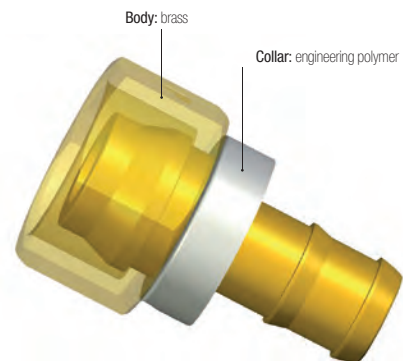

**Silicone-free**

### Self-Fastening Hose Assembly Machine

Machine designed to assemble a barb connector and a self-fastening NBR hose.  
Machine part number: **0650 00 00 05**



#### Tube Cutting and Positioning

Cut the hose square and position the barb connector on the mounting tool.

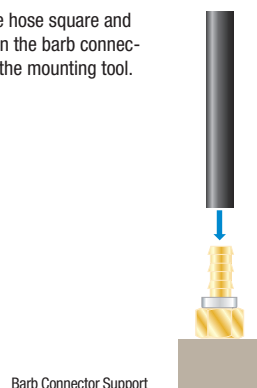

#### Press-Fitting the Tube

Activate the press-fit tool; connection is complete when the tube is fully home on the barb connector. This tool has been designed for use with 5 different diameters and is easy to operate.

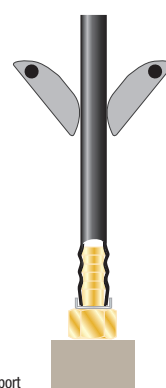



### Regulations

**Industrial**  
DI: 2002/95/EC (RoHS), 2011/65/EC  
DI: 97/23/EC (PED)  
RG: 1907/2006 (REACH)  
CNOMO: E07.21.115N

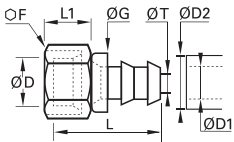

# Self-Fastening Barb Connectors for NBR Hose

## 0132 Self-Fastening Barb Connector for Brass Compression Fitting

	<p>Brass</p> 	<b>ØD</b>	<b>ØD1</b>	<b>ØD2</b>		<b>F</b>	<b>G</b>	<b>L</b>	<b>L1</b>	<b>ØT</b>	<b>kg</b>
		6	6.3	13	<a href="#">0132 06 56</a>	12	16.5	32.5	12.5	4.8	0.010
		8	6.3	13	<a href="#">0132 08 56</a>	14	16.5	29.5	11.5	4.8	0.015
		10	6.3	13	<a href="#">0132 10 56</a>	19	16.5	30	14	4.8	0.028
			9.5	16	<a href="#">0132 10 60</a>	19	19.5	34	14	7.5	0.030
		14	9.5	16	<a href="#">0132 14 60</a>	24	19.5	35.5	15	7.5	0.050
			12.7	19	<a href="#">0132 14 62</a>	24	23.5	39.5	15	10	0.054
		18	12.7	19	<a href="#">0132 18 62</a>	30	23.5	41.5	17	10	0.090
			15.9	23	<a href="#">0132 18 66</a>	30	27	50	17	13.5	0.090
		22	19.1	27	<a href="#">0132 22 69</a>	36	30.5	56.5	17	16	0.128

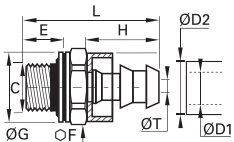

Polymer collar

## 0133..39 Self-Fastening Barb Connector with Bi-Material Seal, Male BSPP Thread

	<p>Brass, zinc-plated steel with NBR seal</p> 	<b>ØD1</b>	<b>ØD2</b>	<b>C</b>		<b>E</b>	<b>F</b>	<b>G</b>	<b>H</b>	<b>L</b>	<b>ØT</b>	<b>kg</b>
		6.3	13	G1/8	<a href="#">0133 56 10 39</a>	5.5	13	14	20	31.5	4.8	0.012
			13	G1/4	<a href="#">0133 56 13 39</a>	7	17	17	20	33.5	4.8	0.018
		9.5	16	G1/4	<a href="#">0133 60 13 39</a>	7	17	17	24	37.5	7.5	0.022
			16	G3/8	<a href="#">0133 60 17 39</a>	9.5	22	22	24	42.5	7.5	0.038
		12.7	19	G3/8	<a href="#">0133 62 17 39</a>	9.5	22	22	28	46.5	10	0.045
			19	G1/2	<a href="#">0133 62 21 39</a>	10.5	27	26	28	48.5	10	0.060
		15.9	23	G1/2	<a href="#">0133 66 21 39</a>	10.5	27	26	36.5	57	13.5	0.064
			23	G3/4	<a href="#">0133 66 27 39</a>	11.5	32	32	36.5	59	13.5	0.095
		19.1	27	G3/4	<a href="#">0133 69 27 39</a>	11.5	32	32	43	65.5	16	0.111

Thread with bi-material seal and polymer collar.  
Bi-material sealing washer part number 0139 can be found in Chapter 9.

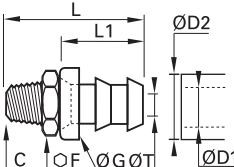
## 0134 Self-Fastening Barb Connector, Male BSPT Thread

	<p>Brass</p> 	<b>ØD1</b>	<b>ØD2</b>	<b>C</b>		<b>F</b>	<b>G</b>	<b>L</b>	<b>L1</b>	<b>ØT</b>	<b>kg</b>
		6.3	13	R1/8	<a href="#">0134 56 10</a>	14	16.5	32.5	20	4.8	0.015
			13	R1/4	<a href="#">0134 56 13</a>	14	16.5	37	20	4.8	0.020
		9.5	16	R1/4	<a href="#">0134 60 13</a>	14	19.5	41	24	7.5	0.022
			16	R3/8	<a href="#">0134 60 17</a>	19	19.5	41.5	24	7.5	0.036
		12.7	19	R3/8	<a href="#">0134 62 17</a>	19	23.5	45.5	28	10	0.038
			19	R1/2	<a href="#">0134 62 21</a>	22	23.5	50	28	10	0.062
		15.9	23	R1/2	<a href="#">0134 66 21</a>	22	27	58.5	36.5	13.5	0.056
			23	R3/4	<a href="#">0134 66 27</a>	27	27	60.5	36.5	13.5	0.101
		19.1	27	R3/4	<a href="#">0134 69 27</a>	27	30.5	67	43	16	0.108

Polymer collar

Self-fastening NBR hose is selected by nominal diameter; for example:

Barb Connector	O.D. (Tube)	Ø DN (Tube)	Self-Fastening NBR hose
<b>0132 10 56</b>	<b>10</b>	<b>1/4</b>	<b>10..H 56...</b>



# Brass Adaptors

## 0122 Barb Connector for Hose

ØD1	ØD2	L	L1	ØT min	kg	Brass	
						ØD3	L
4	4	0122 04 04	6	37.5	22.5	3	0.004
5	4	0122 05 04	6	37.5	22.5	3	0.003
6	4	0122 06 04	6	37.5	22.5	3	0.005
	7	0122 06 07	9	37.5	22.5	6	0.007
8	6	0122 08 06	8	40	22.5	5	0.007
	7	0122 08 07	9	40	22.5	6	0.008
	10	0122 08 10	12.5	40	22.5	9	0.013
10	7	0122 10 07	9	43	22.5	6	0.010
	10	0122 10 10	12.5	43	22.5	9	0.014
12	10	0122 12 10	12.5	43	22.5	9	0.014
	13	0122 12 13	15	50	29.5	12	0.018
14	13	0122 14 13	15	52	29.5	12	0.019
	16	0122 14 16	18.5	60.5	38	15	0.308
15	13	0122 15 13	15	52	29.5	12	0.019
	16	0122 15 16	18.5	60.5	38	15	0.032
16	13	0122 16 13	15	53.5	29.5	12	0.021
	16	0122 16 16	18.5	62	38	15	0.032
18	16	0122 18 16	18.5	62	38	15	0.032
	19	0122 18 19	21.5	62	38	18	0.041
20	16	0122 20 16	18.5	64	38	15	0.034
	19	0122 20 19	21.5	64	38	18	0.038
22	19	0122 22 19	21.5	64	38	18	0.039
	19	0122 25 19	21.5	70	38	18	0.049
25	25	0122 25 25	27.5	70	38	24	0.054
28	25	0122 28 25	27.5	70	38	24	0.087

## 0165 Barb Connector for Flexible Tubing

ØD1	ØD2	L	L1	ØT min	kg	Brass	
						ØD3	L
4	4	0165 04 06	4.3	30	15	2	0.002
5	4	0165 05 06	4.3	30	15	2	0.010
	4	0165 06 06	4.3	30	15	2	0.003
6	6	0165 06 08	6.4	30	15	4	0.004
	8	0165 06 10	8.4	30	15	4	0.004
8	6	0165 08 08	6.4	32.5	15	4	0.006
	8	0165 08 10	8.4	32.5	15	6	0.006
	10	0165 08 12	10.7	37.5	20	8	0.009
10	8	0165 10 10	8.4	35.5	15	6	0.008
	10	0165 10 12	10.7	40.5	20	8	0.010
12	12	0165 10 14	12.7	40.5	20	8	0.012
	10	0165 12 12	10.7	40.5	20	8	0.011
12	12	0165 12 14	12.7	40.5	20	10	0.013
	14	0165 14 14	12.7	42.5	20	10	0.014
15	13	0165 15 16	13.7	42.5	20	11	0.016
16	13	0165 16 16	13.7	44	20	11	0.018

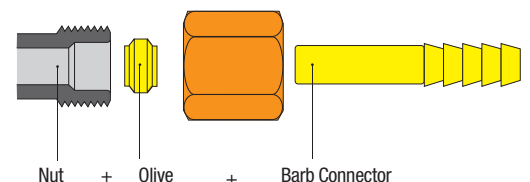

### Assembly: Barb Connectors

Our barb connectors 0122 and 0165 are designed to be used with different types of hose. They are secured using the nut and olive provided with the fitting.



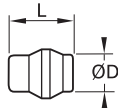

# Brass Adaptors

## 0126 Plug for Compression Fitting

	Brass  	<b>ØD</b>		<b>L</b>	<b>kg</b>
		4	<a href="#">0126 04 00</a>	10	0.001
		5	<a href="#">0126 05 00</a>	10	0.003
		6	<a href="#">0126 06 00</a>	10	0.003
		8	<a href="#">0126 08 00</a>	11.5	0.006
		10	<a href="#">0126 10 00</a>	13	0.010
		12	<a href="#">0126 12 00</a>	13	0.014
		14	<a href="#">0126 14 00</a>	13.5	0.020
		15	<a href="#">0126 15 00</a>	13.5	0.022
		16	<a href="#">0126 16 00</a>	16	0.029
		18	<a href="#">0126 18 00</a>	16	0.039
		20	<a href="#">0126 20 00</a>	16	0.045
		22	<a href="#">0126 22 00</a>	18	0.003
28	<a href="#">0126 28 00</a>	19.5	0.108		

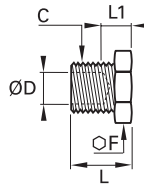

The plug is used to blank off an outlet in a compression fitting, replacing the olive.  
When an open outlet is required, simply dismantle and replace the plug with the tube olive, reusing the nut.  
The plug is also reusable.

## 0125 Tube End Plug for Compression Fitting

	Brass  	<b>ØD</b>	<b>C</b>		<b>F</b>	<b>L</b>	<b>L1</b>	<b>kg</b>
		4	M8x1	<a href="#">0125 04 00</a>	10	12	8	0.006
		6	M10x1	<a href="#">0125 06 00</a>	11	13.5	9.5	0.008
		8	M12x1	<a href="#">0125 08 00</a>	14	14	9	0.013
		10	M16x1.5	<a href="#">0125 10 00</a>	17	18	11	0.025
		12	M18x1.5	<a href="#">0125 12 00</a>	19	18	11	0.030
		14	M20x1.5	<a href="#">0125 14 00</a>	22	19	11	0.041

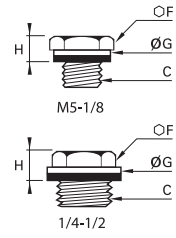

This plug enables unused tubes to be blanked off.  
The male thread on the plug has the same pitch as the female thread on the sleeve nut of a standard Parker Legris fitting.  
Therefore the plug screwed into the sleeve nut blanks off the tube.  
To reopen the passage, simply unscrew the plug and fit the required coupler.  
No further treatment of the tube is required.

## 0220 Hex Head Plug with Captive Sealing Washer, Male BSPP and Metric Thread

	Brass, technical polymer  	<b>C</b>		<b>F</b>	<b>G</b>	<b>H</b>	<b>kg</b>
		M5x0.8	<a href="#">0220 19 00</a>	8	8	5	0.002
		G1/8	<a href="#">0220 10 00</a>	14	14	7.5	0.011
		G1/4	<a href="#">0220 13 00</a>	17	17	7.5	0.019
		G3/8	<a href="#">0220 17 00</a>	17	22	8.5	0.024
		G1/2	<a href="#">0220 21 00</a>	22	27	10	0.040

Thread with pre-assembled washer.  
M5: with screwdriver slot for tightening.  
Maximum allowable working pressure = 20 bar.  
Part number with suffix 99, maximum allowable working pressure = 250 bar, example: 0220 19 00 99.  
Conforms to BNA 229 (with the exception of M5 model): BSPP thread, ISO ISO 228-1; metric thread, ISO NFE 03-054.

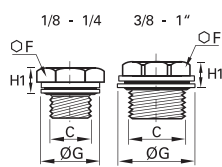
## 0220..39 Hex Head Plug with Bi-Material Seal, Male BSPP Thread

	Brass, zinc-plated steel with NBR seal  	<b>C</b>		<b>F</b>	<b>G</b>	<b>H1</b>	<b>kg</b>
		G1/8	<a href="#">0220 10 00 39</a>	14	14	6.5	0.012
		G1/4	<a href="#">0220 13 00 39</a>	17	17	6.5	0.020
		G3/8	<a href="#">0220 17 00 39</a>	17	22	8	0.025
		G1/2	<a href="#">0220 21 00 39</a>	22	26	9	0.043
		G3/4	<a href="#">0220 27 00 39</a>	22	32	10	0.060
		G1	<a href="#">0220 34 00 39</a>	27	39.5	10.5	0.089

Plug with bi-material seal.  
Bi-material washers part number 0139 can be found in Chapter 9.

# Brass Adaptors

## 0120 Stud Standpipe, Male BSPT Thread



Brass

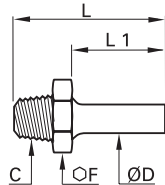

ØD	C		F	L	L1	kg
4	R1/8	<a href="#">0120 04 10</a>	11	25.5	14	0.007
5	R1/8	<a href="#">0120 05 10</a>	11	26	14.5	0.007
6	R1/8	<a href="#">0120 06 10</a>	11	26.5	15	0.008
	R1/4	<a href="#">0120 06 13</a>	14	31	15	0.015
8	R1/8	<a href="#">0120 08 10</a>	11	28.5	17	0.009
	R1/4	<a href="#">0120 08 13</a>	14	33	17	0.016
	R3/8	<a href="#">0120 08 17</a>	17	33.5	17	0.020
10	R1/4	<a href="#">0120 10 13</a>	14	36	20	0.018
	R3/8	<a href="#">0120 10 17</a>	17	36.5	20	0.022
	R1/2	<a href="#">0120 10 21</a>	22	41	20	0.038
12	R1/4	<a href="#">0120 12 13</a>	14	36	20	0.018
	R3/8	<a href="#">0120 12 17</a>	17	36.5	20	0.022
14	R1/2	<a href="#">0120 12 21</a>	22	41	20	0.041
	R3/8	<a href="#">0120 14 17</a>	17	38	21.5	0.024
15	R1/2	<a href="#">0120 14 21</a>	22	42.5	21.5	0.041
	R3/8	<a href="#">0120 15 17</a>	17	38	21.5	0.023
16	R1/2	<a href="#">0120 15 21</a>	22	42.5	21.5	0.041
	R3/8	<a href="#">0120 16 17</a>	17	39.5	23	0.024
18	R1/2	<a href="#">0120 16 21</a>	22	44	23	0.042
	R3/4	<a href="#">0120 18 21</a>	27	44.5	23.5	0.042
20	R3/4	<a href="#">0120 18 27</a>	27	47.5	23.5	0.071
	R3/4	<a href="#">0120 20 27</a>	27	49	25	0.071
22	R3/4	<a href="#">0120 22 27</a>	27	48.5	25.5	0.067
	R1	<a href="#">0120 22 34</a>	36	52.5	25.5	0.116
25	R1	<a href="#">0120 25 34</a>	36	57	30	0.119
28	R1	<a href="#">0120 28 34</a>	36	57	30	0.138

## 0112 Sleeve Nut for Compression Fitting, Male Metric Thread



Brass

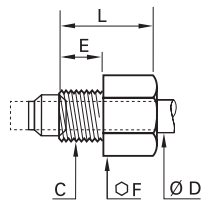



ØD	C		E	F	L	kg
4	M8x1	<a href="#">0112 04 00</a>	7	10	13	0.005
5	M10x1	<a href="#">0112 05 00</a>	7.5	11	13.5	0.007
6	M10x1	<a href="#">0112 06 00</a>	7.5	11	13.5	0.006
8	M12x1	<a href="#">0112 08 00</a>	8	13	15	0.008
10	M16x1.5	<a href="#">0112 10 00</a>	11	17	18	0.018
12	M18x1.5	<a href="#">0112 12 00</a>	11	19	18	0.021
14	M20x1.5	<a href="#">0112 14 00</a>	11	22	18	0.026

This product was designed to allow the tube to be fitted directly into the tapped port in a body using a standard Parker Legris olive.  
For the corresponding drawings (cavity for Parker Legris olive), please consult us.

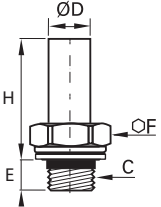

# Brass Adaptors

## 0128..39 Stud Standpipe with Bi-Material Seal, Male BSPP Thread

	Brass, zinc-plated steel with NBR seal		<b>ØD</b>	<b>C</b>		<b>E</b>	<b>F</b>	<b>H</b>	<b>Kg</b>
			4	G1/8	<a href="#">0128 04 10 39</a>	7.5	13	20	0.009
				G1/4	<a href="#">0128 04 13 39</a>	9	17	22	0.015
			6	G1/8	<a href="#">0128 06 10 39</a>	7.5	13	21	0.010
				G1/4	<a href="#">0128 06 13 39</a>	9	17	23	0.016
			8	G1/8	<a href="#">0128 08 10 39</a>	7.5	13	23	0.011
				G1/4	<a href="#">0128 08 13 39</a>	9	17	25	0.017
				G3/8	<a href="#">0128 08 17 39</a>	12	22	26	0.033
				G1/4	<a href="#">0128 10 13 39</a>	9	17	28	0.018
			10	G3/8	<a href="#">0128 10 17 39</a>	12	22	29	0.034
				G1/2	<a href="#">0128 10 21 39</a>	27	27	30	0.048
			14	G3/8	<a href="#">0128 14 17 39</a>	12	22	30.5	0.035
				G1/2	<a href="#">0128 14 21 39</a>	27	27	31.5	0.049
			18	G1/2	<a href="#">0128 18 21 39</a>	27	27	33.5	0.052
				G3/4	<a href="#">0128 18 27 39</a>	14	32	34.5	0.084
			22	G3/4	<a href="#">0128 22 27 39</a>	14	32	36.5	0.082
				G1	<a href="#">0128 22 34 39</a>	16.5	41	38	0.123
			28	G1	<a href="#">0128 28 34 39</a>	16.5	41	42.5	0.149

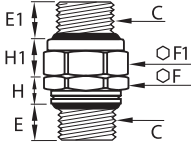

With bi-material seal.  
Bi-material washers part number 0139 can be found in Chapter 9.

## 0151..39 Straight Male Orientable Adaptor, with Bi-Material Seal, Male BSPP Thread

	Brass, NBR, zinc-plated steel with NBR seal		<b>C</b>		<b>E</b>	<b>E1</b>	<b>F</b>	<b>F1</b>	<b>H</b>	<b>H1</b>	<b>kg</b>
			G1/8	<a href="#">0151 10 10 39</a>	5.5	7	13	14	6	6.5	0.017
			G1/4	<a href="#">0151 13 13 39</a>	7	8.5	17	19	6.5	9	0.036
			G3/8	<a href="#">0151 17 17 39</a>	9.5	9.5	22	22	9	9	0.057
			G1/2	<a href="#">0151 21 21 39</a>	10.5	10.5	27	27	10	10	0.083
			G3/4	<a href="#">0151 27 27 39</a>	11.5	11.5	32	32	11	10	0.121
			G1	<a href="#">0151 34 34 39</a>	13	13.5	41	41	12.5	10.5	0.230

With bi-material seal.  
Bi-material washers part number 0139 can be found in Chapter 9.

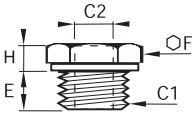
## 0168..39 Reducer, with Bi-Material Seal, Male BSPP Thread/Female BSPP and Metric Thread

	Brass, zinc-plated steel with NBR seal		<b>C1</b>	<b>C2</b>		<b>E</b>	<b>F</b>	<b>H</b>	<b>kg</b>
			G1/8	M5x0.8	<a href="#">0168 10 19 39</a>	8	14	4.5	0.009
			G1/4	M5x0.8	<a href="#">0168 13 19 39</a>	8	17	5	0.018
				G1/8	<a href="#">0168 13 10 39</a>	8	17	5	0.012
			G3/8	G1/8	<a href="#">0168 17 10 39</a>	10	19	5	0.020
				G1/4	<a href="#">0168 17 13 39</a>	10	19	5	0.013
				G1/8	<a href="#">0168 21 10 39</a>	12	24	7.5	0.052
			G1/2	G1/4	<a href="#">0168 21 13 39</a>	12	24	7.5	0.043
				G3/8	<a href="#">0168 21 17 39</a>	12	24	7.5	0.030
				G1/4	<a href="#">0168 27 13 39</a>	12	32	9.5	0.099
			G3/4	G3/8	<a href="#">0168 27 17 39</a>	12	32	9.5	0.086
				G1/2	<a href="#">0168 27 21 39</a>	12	32	9.5	0.065

With bi-material seal.  
Bi-material washers part number 0139 can be found in Chapter 9.

# Brass Adaptors

## 0127 Tube Support for Polymer Tubing



Brass

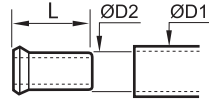

	ØD1	ØD2		L	kg
4	2		<a href="#">0127 04 00</a>	11	0.001
	2.7		<a href="#">0127 04 27</a>	11	0.001
5	3		<a href="#">0127 05 03</a>	11	0.001
	3.3		<a href="#">0127 05 00</a>	11.5	0.009
6	4		<a href="#">0127 06 00</a>	11.5	0.001
8	5.5		<a href="#">0127 08 55</a>	14	0.001
	6		<a href="#">0127 08 00</a>	14	0.001
10	7		<a href="#">0127 10 07</a>	18	0.001
	7.5		<a href="#">0127 10 75</a>	18	0.001
12	8		<a href="#">0127 12 00</a>	18	0.002
	8		<a href="#">0127 12 08</a>	18	0.002
14	9		<a href="#">0127 12 09</a>	18	0.002
	10		<a href="#">0127 12 00</a>	18	0.001
15	11		<a href="#">0127 14 11</a>	18	0.002
	12		<a href="#">0127 14 00</a>	18	0.002
16	12		<a href="#">0127 15 12</a>	18	0.002
18	13		<a href="#">0127 16 13</a>	18	0.003
20	14		<a href="#">0127 18 14</a>	19.5	0.003
22	15		<a href="#">0127 20 15</a>	20.5	0.003
25	16		<a href="#">0127 22 16</a>	21	0.004
	19		<a href="#">0127 25 19</a>	25	0.007

This tube support guarantees good gripping, at high temperatures and pressures, by preventing collapsing of the tube.

# Stainless Steel Compression Fitting Range

## Stainless Steel Fittings

### Stud Fittings

- |                                  |                                 |                                  |                                  |                                 |                                  |                                 |
|----------------------------------|---------------------------------|----------------------------------|----------------------------------|---------------------------------|----------------------------------|---------------------------------|
| <b>1805</b><br>BSPT<br>Page 5-34 | <b>1805</b><br>NPT<br>Page 5-34 | <b>1814</b><br>BSPP<br>Page 5-34 | <b>1809</b><br>BSPT<br>Page 5-35 | <b>1809</b><br>NPT<br>Page 5-35 | <b>1820</b><br>BSPT<br>Page 5-35 | <b>1820</b><br>NPT<br>Page 5-35 |
|----------------------------------|---------------------------------|----------------------------------|----------------------------------|---------------------------------|----------------------------------|---------------------------------|



### Tube-to-Tube Fittings

- |                          |                          |                          |                          |
|--------------------------|--------------------------|--------------------------|--------------------------|
| <b>1806</b><br>Page 5-36 | <b>1816</b><br>Page 5-36 | <b>1802</b><br>Page 5-36 | <b>1804</b><br>Page 5-36 |
|--------------------------|--------------------------|--------------------------|--------------------------|



### Complementary Fittings

- |                          |                          |                          |
|--------------------------|--------------------------|--------------------------|
| <b>1866</b><br>Page 5-39 | <b>1824</b><br>Page 5-39 | <b>1810</b><br>Page 5-39 |
|--------------------------|--------------------------|--------------------------|



### Accessories

- |                          |                          |
|--------------------------|--------------------------|
| <b>1822</b><br>Page 5-39 | <b>1827</b><br>Page 5-39 |
|--------------------------|--------------------------|



# Stainless Steel Compression Fittings

**Manufactured in 316L stainless steel**, these fittings combine all the advantages of the "universal" compression fitting with **excellent resistance** to environmental conditions and **corrosive fluids**. They are pressure and temperature-resistant and are able to withstand strong vibration and water hammer.

## Product Advantages

### For Use in Many Environments

- Manufactured in 316L stainless steel
- Suitable for all environments and fluids
- Resistant to water hammer and vibration
- Excellent sealing and retention of the tube
- Suitable for pneumatic and medium pressure hydraulic applications
- Metallic sealing guarantees maximum service life

### Many Tube Options

- Possibility of easily connecting different tube materials and diameters to the same fitting body
- No tube support required for rigid and semi-rigid polyamide tubing below 12 mm



- Applications**
- Food Process
  - Fluid Transmission
  - Pneumatics
  - Automotive Process
  - Petrochemical
  - Chemical
  - Offshore Oil & Gas

## Technical Characteristics

<b>Compatible Fluids</b>	Many fluids					
<b>Working Pressure</b>	Vacuum to 400 bar (80 bar in corrosive environments)					
<b>Working Temperature</b>	-40°C to +250°C					
<b>Tightening Torques</b>	DN	6	8	10	12	16
	daN.m	2	3	4	6.5	9.5

Reliable performance is dependent upon the type of fluid conveyed and tubing being used. Guaranteed for use with a vacuum of 755 mm Hg (99% vacuum).

### Component Materials

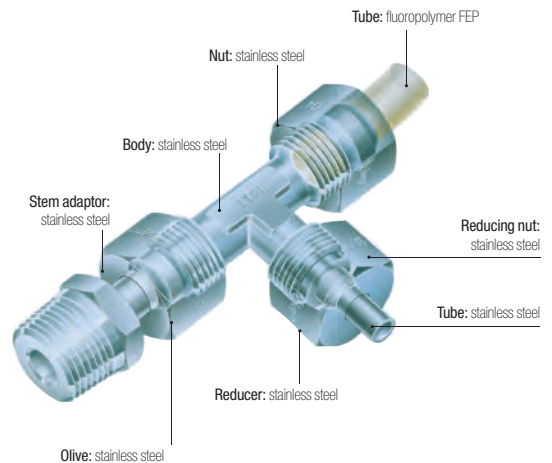

**Silicone-free**

### Maximum Bore Diameters

The table below shows the recommended compatibility of tube size, BSPP male thread and maximum bore.

Tube O.D	BSPP Thread	Max. Bore
6	G1/8	4
6-8-10	G1/4	7
10-12	G3/8	11
16	G1/2	14

### Tube Length for Assembly

Minimum length of tube (L) between 2 fittings.

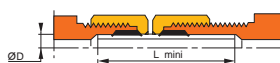

ØD	L mm	ØD	L mm
4	26.5	10	39
6	26	12	39
8	32	16	46.5

### Regulations

- DI: 2002/95/EC (RoHS), 2011/65/EC
- DI: 97/23/EC (PED)
- RG: 1935/2004
- RG: 1907/2006 (REACH)
- DI: 94/09/EC (ATEX)
- FDA: 21 CFR 177.1550
- NACE MR0175: compatible materials
- ISO 15156-1/-2/-3: compatible materials

# Stainless Steel Compression Fittings

## Installation

### Fitting

The fitting comprises three parts (body/olive/nut). For assembly procedure, please see Brass Compression Fitting page.

#### Diagram: Assembled Fitting

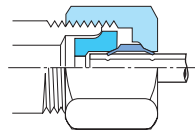

A very slight distortion of the tube appears; this shows the fitting has been correctly tightened.

### Orientable Elbow Assembly

Elbow **1802** + Adaptor **1820** =

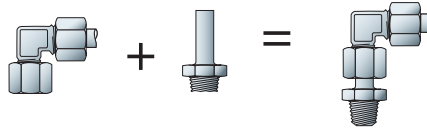

### Customised Fittings

If our standard range does not meet your needs, Parker Legris can develop customised solutions for your applications.

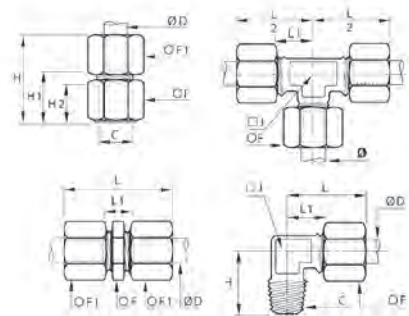

## Technical Characteristics

The use of Parker Legris stainless steel compression fittings is dependant on the tube material. Tables of recommended working pressure for the different tubes are shown below.

### Recommended Tube Type

#### Semi-rigid polyamide or fluoropolymer tube

#### Stainless steel tube

"Thin Wall" cold-drawn seamless, annealed and passivated: wall thickness tolerance +/-0.1 mm. For use with "thin wall" stainless steel tube from 6 mm to 16 mm O.D., maximum wall thickness 1 mm.

### Recommended Tube/Fitting Assembly Configurations

Assembled using Parker Legris olive and nut in stainless steel, with a tube support.

#### Stainless steel tube

Stainless steel tube: in cold-rolled straight lengths  
Coiled annealed stainless tube: reduces working pressure by 35%; do not use if there is vibration.

#### Semi-Rigid Polyamide Tube

Maximum Working Pressure (bar)

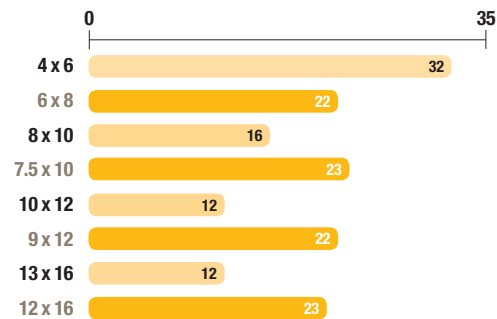

#### Stainless Steel Tube

Maximum Working Pressure (bar)

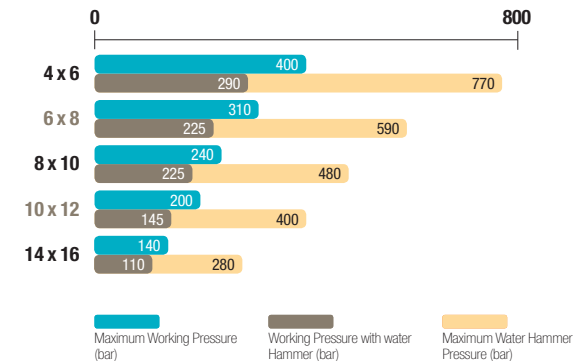



### Working Pressure Coefficients for Semi-Rigid Tubing

Temperature °C	-40°C / -15°C	-15°C / +30°C	+30°C / +50°C	+50°C / +70°C	+70°C / +100°C
Factor	1.8	1	0.68	0.55	0.31

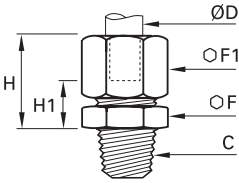

The above recommendations are given in good faith. However, since each application is different, it is advisable to undertake tests in actual working conditions.

# Stainless Steel Compression Fittings

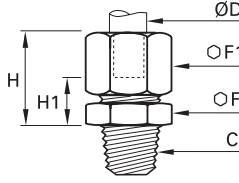

## 1805 Stud Fitting, Male BSPT Thread

	Stainless steel 316L		<b>ØD</b>	<b>C</b>		<b>F</b>	<b>F1</b>	<b>H<sub>max</sub></b>	<b>H1</b>	<b>kg</b>
			6	R1/8	<a href="#">1805 06 10</a>	12	13	19.5	7.5	0.017
			R1/4	<a href="#">1805 06 13</a>	14	13	19.5	7.5	0.025	
			8	R1/8	<a href="#">1805 08 10</a>	13	14	21	7	0.019
			R1/4	<a href="#">1805 08 13</a>	14	14	21	7	0.024	
			10	R1/4	<a href="#">1805 10 13</a>	17	19	25.5	9	0.044
			R3/8	<a href="#">1805 10 17</a>	17	19	25.5	9	0.049	
			R1/2	<a href="#">1805 10 21</a>	22	19	26.5	10	0.076	
			R1/4	<a href="#">1805 12 13</a>	19	22	26	9	0.054	
			12	R3/8	<a href="#">1805 12 17</a>	19	22	26	9	0.058
			R1/2	<a href="#">1805 12 21</a>	22	22	27	10	0.081	
			16	R3/8	<a href="#">1805 16 17</a>	24	27	28.5	9.5	0.086
			R1/2	<a href="#">1805 16 21</a>	24	27	28.5	9.5	0.094	

## 1805 Stud Fitting, Male NPT Thread

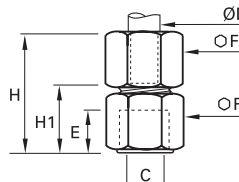

	Stainless steel 316L		<b>ØD</b>	<b>C</b>		<b>F</b>	<b>F1</b>	<b>H<sub>max</sub></b>	<b>H1</b>	<b>kg</b>
			6	NPT1/8	<a href="#">1805 06 11</a>	12	13	19.5	7.5	0.018
			NPT1/4	<a href="#">1805 06 14</a>	14	13	19.5	7.5	0.027	
			NPT3/8	<a href="#">1805 06 18</a>	19	13	20.5	8.5	0.033	
			NPT1/2	<a href="#">1805 06 22</a>	22	13	21.5	9.5	0.049	
			8	NPT1/8	<a href="#">1805 08 11</a>	13	14	21	7	0.020
			NPT1/4	<a href="#">1805 08 14</a>	14	14	21	7	0.027	
			10	NPT1/4	<a href="#">1805 10 14</a>	17	19	25.5	9	0.045
			NPT3/8	<a href="#">1805 10 18</a>	19	19	25.5	9	0.055	
			NPT1/2	<a href="#">1805 10 22</a>	22	19	26.5	10	0.083	
			12	NPT1/4	<a href="#">1805 12 14</a>	19	22	26	9	0.056
			NPT3/8	<a href="#">1805 12 18</a>	19	22	26	9	0.061	
			NPT1/2	<a href="#">1805 12 22</a>	22	22	27	10	0.087	
			16	NPT3/8	<a href="#">1805 16 18</a>	24	27	28.5	9.5	0.087
			NPT1/2	<a href="#">1805 16 22</a>	24	27	28.5	9.5	0.097	

## 1814 Stud Fitting, Female BSPP Thread



	Stainless steel 316L		<b>ØD</b>	<b>C</b>		<b>E</b>	<b>F</b>	<b>F1</b>	<b>H<sub>max</sub></b>	<b>H1</b>	<b>kg</b>
			6	G1/8	<a href="#">1814 06 10</a>	7.5	14	13	29	17	0.023
			G1/4	<a href="#">1814 06 13</a>	11	17	13	29	21	0.032	
			8	G1/4	<a href="#">1814 08 13</a>	11	17	14	34.5	20.5	0.033
			10	G3/8	<a href="#">1814 10 17</a>	11.5	22	19	38.5	22	0.064
			G1/2	<a href="#">1814 10 21</a>	15	27	19	43	26.5	0.093	
			12	G3/8	<a href="#">1814 12 17</a>	11.5	22	22	39	22	0.072
			G1/2	<a href="#">1814 12 21</a>	15	27	22	43.5	26.5	0.100	
			16	G1/2	<a href="#">1814 16 21</a>	15	27	27	45	26	0.120

# Stainless Steel Compression Fittings



## 1809 Stud Elbow, Male BSPT Thread

Stainless steel 316L		ØD	C		F	H	J	L <sub>max</sub>	L1	kg
6		6	R1/8	<a href="#">1809 06 10</a>	13	18	8	25.5	13.5	0.021
			R1/4	<a href="#">1809 06 13</a>	13	23	10	25.5	13.5	0.030
8		8	R1/8	<a href="#">1809 08 10</a>	14	20.5	10	28.5	14.5	0.027
			R1/4	<a href="#">1809 08 13</a>	14	23	10	28.5	14.5	0.031
10		10	R1/4	<a href="#">1809 10 13</a>	19	25	12	32.5	16	0.050
			R3/8	<a href="#">1809 10 17</a>	19	25.5	12	32.5	16	0.058
12		12	R1/2	<a href="#">1809 10 21</a>	19	32	18	36.5	20	0.091
			R1/4	<a href="#">1809 12 13</a>	22	26	14	34	17	0.067
16		16	R3/8	<a href="#">1809 12 17</a>	22	27	14	34	17	0.070
			R1/2	<a href="#">1809 12 21</a>	22	32	18	37	20	0.098
16		16	R3/8	<a href="#">1809 16 17</a>	27	28.5	18	39.5	21	0.107
			R1/2	<a href="#">1809 16 21</a>	27	31.5	18	39.5	21	0.114



## 1809 Stud Elbow, Male NPT Thread

Stainless steel 316L		ØD	C		F	H	J	L <sub>max</sub>	L1	kg
6		6	NPT1/8	<a href="#">1809 06 11</a>	13	19.5	8	25.5	13.5	0.022
			NPT1/4	<a href="#">1809 06 14</a>	13	25.5	10	25.5	13.5	0.031
			NPT3/8	<a href="#">1809 06 18</a>	13	28	12	27	15	0.046
8		8	NPT1/2	<a href="#">1809 06 22</a>	13	34	12	29	17	0.072
			NPT1/8	<a href="#">1809 08 11</a>	14	22	10	28.5	14.5	0.028
			NPT1/4	<a href="#">1809 08 14</a>	14	25.5	10	28.5	14.5	0.033
10		10	NPT1/4	<a href="#">1809 10 14</a>	19	27.5	12	32.5	16	0.052
			NPT3/8	<a href="#">1809 10 18</a>	19	28	12	32.5	16	0.061
			NPT1/2	<a href="#">1809 10 22</a>	19	35	18	36.5	20	0.096
12		12	NPT1/4	<a href="#">1809 12 14</a>	22	28.5	14	34	17	0.069
			NPT3/8	<a href="#">1809 12 18</a>	22	29.5	14	34	17	0.074
			NPT1/2	<a href="#">1809 12 22</a>	22	35	18	37	20	0.102
16		16	NPT3/8	<a href="#">1809 16 18</a>	27	31	18	39.5	21	0.110
			NPT1/2	<a href="#">1809 16 22</a>	27	34.5	18	39.5	21	0.116

## 1820 Stud Standpipe, Male BSPT Thread



Stainless steel 316L		ØD	C		F	L	L1	kg
6		6	R1/8	<a href="#">1820 06 10</a>	12	26.5	15	0.009
			R1/4	<a href="#">1820 06 13</a>	14	31	15	0.017
8		8	R1/8	<a href="#">1820 08 10</a>	12	28.5	17	0.008
			R1/4	<a href="#">1820 08 13</a>	14	33	17	0.016
10		10	R1/4	<a href="#">1820 10 13</a>	14	36	20	0.016
			R3/8	<a href="#">1820 10 17</a>	17	36.5	20	0.025
12		12	R1/2	<a href="#">1820 10 21</a>	22	41	20	0.052
			R1/4	<a href="#">1820 12 13</a>	14	36	20	0.016
16		16	R3/8	<a href="#">1820 12 17</a>	17	36.5	20	0.022
			R1/2	<a href="#">1820 12 21</a>	22	41	20	0.048
16		16	R3/8	<a href="#">1820 16 17</a>	17	39.5	23	0.022
			R1/2	<a href="#">1820 16 21</a>	22	44	23	0.038

## 1820 Stud Standpipe, Male NPT Thread

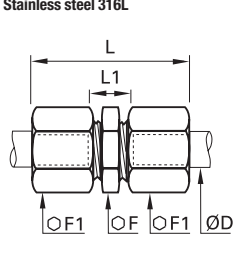

Stainless steel 316L		ØD	C		F	L	L1	kg
6		6	NPT1/8	<a href="#">1820 06 11</a>	12	26.5	15	0.009
			NPT1/4	<a href="#">1820 06 14</a>	14	31	15	0.019
8		8	NPT1/8	<a href="#">1820 08 11</a>	12	28.5	17	0.009
			NPT1/4	<a href="#">1820 08 14</a>	14	33	17	0.019
10		10	NPT1/4	<a href="#">1820 10 14</a>	14	36	20	0.018
			NPT3/8	<a href="#">1820 10 18</a>	19	36.5	20	0.032
12		12	NPT1/2	<a href="#">1820 10 22</a>	22	41	20	0.060
			NPT1/4	<a href="#">1820 12 14</a>	14	36	20	0.019
16		16	NPT3/8	<a href="#">1820 12 18</a>	19	36.5	20	0.028
			NPT1/2	<a href="#">1820 12 22</a>	22	41	20	0.053
16		16	NPT3/8	<a href="#">1820 16 18</a>	19	39.5	23	0.027
			NPT1/2	<a href="#">1820 16 22</a>	22	44	23	0.042

# Stainless Steel Compression Fittings

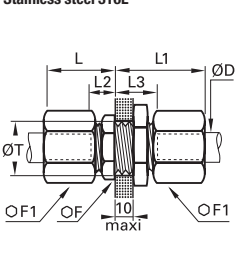

## 1806 Equal Tube-to-Tube Connector

	Stainless steel 316L 	<b>ØD</b>		<b>F</b>	<b>F1</b>	<b>L<sub>max</sub></b>	<b>L1</b>	<b>kg</b>
		6	<a href="#">1806 06 00</a>	12	13	34.5	11	0.025
		8	<a href="#">1806 08 00</a>	13	14	38.5	10	0.029
		10	<a href="#">1806 10 00</a>	17	19	46	13	0.066
		12	<a href="#">1806 12 00</a>	19	22	47	13	0.085
		16	<a href="#">1806 16 00</a>	24	27	51	13	0.135

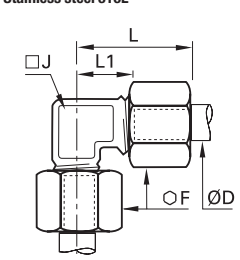

## 1816 Equal Bulkhead Connector

	Stainless steel 316L 	<b>ØD</b>		<b>F</b>	<b>F1</b>	<b>L<sub>max</sub></b>	<b>L1<sub>max</sub></b>	<b>L2</b>	<b>L3</b>	<b>ØT<sub>min</sub></b>	<b>kg</b>
		6	<a href="#">1816 06 00</a>	13	13	28	19	7.5	17	10.5	0.034
		8	<a href="#">1816 08 00</a>	14	14	29	20	7	17	12.5	0.042
		10	<a href="#">1816 10 00</a>	19	19	33	25	9	19	16.5	0.094
		12	<a href="#">1816 12 00</a>	22	22	33	25	9	19	18.5	0.113
		16	<a href="#">1816 16 00</a>	27	27	36	28	9.5	19.5	22.5	0.179

## 1802 Equal Elbow

	Stainless steel 316L 	<b>ØD</b>		<b>F</b>	<b>J</b>	<b>L<sub>max</sub></b>	<b>L1</b>	<b>kg</b>
		6	<a href="#">1802 06 00</a>	13	8	25.5	13.5	0.028
		8	<a href="#">1802 08 00</a>	14	10	28.5	14.5	0.035
		10	<a href="#">1802 10 00</a>	19	12	32.5	16	0.071
		12	<a href="#">1802 12 00</a>	22	14	34	17	0.093
		16	<a href="#">1802 16 00</a>	27	18	39.5	21	0.151

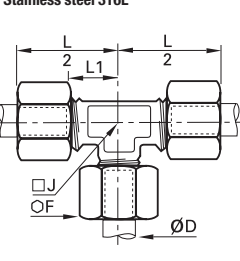
## 1804 Equal Tee

	Stainless steel 316L 	<b>ØD</b>		<b>F</b>	<b>J</b>	<b>L1</b>	<b>L/2</b>	<b>kg</b>
		6	<a href="#">1804 06 00</a>	13	8	13.5	25.5	0.040
		8	<a href="#">1804 08 00</a>	14	10	14.5	28.5	0.050
		10	<a href="#">1804 10 00</a>	19	12	16	32.5	0.103
		12	<a href="#">1804 12 00</a>	22	14	17	34	0.133
		16	<a href="#">1804 16 00</a>	27	18	21	39.5	0.214

Stainless Steel  
Compression Fittings

Compression Fittings

# Complementary Stainless Steel Fittings Reducers, Olives and Nuts

This innovative reducer system, using a full range of nuts and olives, enables **different diameters** of stainless steel, fluoropolymer or polymer tubes to be fitted onto **a single Parker Legris compression fitting**.

## Product Advantages

### Efficient Solution

Reduces envelope dimensions  
Quick and easy to assemble, whatever the diameters and tube material  
Improved stock management  
Silicone-free

### Multiple Combinations

A single connector for up to 3 different tube materials and sizes.  
Example:
 

- Advanced PE tubing 6 mm O.D.
- stainless steel tubing 8 mm O.D.
- fluoropolymer tubing 12 mm O.D. or braided PVC hose 10 mm I.D.

 A full range of olives and nuts to optimise all assembly operations



Food Process  
Fluid Transmission  
Pneumatics  
Automotive Process  
Petrochemical  
Cooling & Heating  
Chemical  
Offshore Oil & Gas

Applications

## Reducer Assembly Procedure

Operation	Assembly Sequence	Assembled Fitting
<p><b>1</b> <b>Assemble the reducer</b> Place the reducer in the fitting body.</p>	<p><b>1</b></p>	
<p><b>2</b> <b>Assemble the nut and olive</b> Place the nut and then the olive onto the tube.</p>	<p><b>2</b></p>	
<p><b>3</b> <b>Assemble the nut</b> Push the tube into the fitting until it bottoms on the reducer. Tighten the nut to the recommended torque (see opposite page).</p>	<p><b>3</b></p>	

## Assembly: Barb Connectors

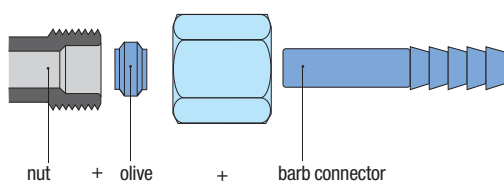



### Regulations

DI: 2002/95/EC (RoHS), 2011/65/EC  
DI: 97/23/EC (PED)  
RG: 1935/2004  
RG: 1907/2006 (REACH)  
DI: 94/09/EC (ATEX)  
FDA: 21 CFR 177.1550  
NACE MR0175: compatible materials  
ISO 15156-1/-2/-3: compatible materials

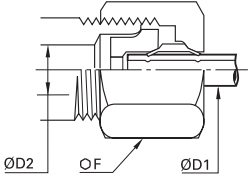

Our barb connector 1822 is designed to be also used with different types of hose. It is secured using the nut and olive provided with the fitting.

# Stainless Steel Compression Fittings

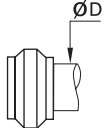

## 1866 3-Piece Reducer

	Stainless steel 316L			<b>ØD1</b>	<b>ØD2</b>		<b>F</b>	<b>kg</b>
	6	8		<a href="#">1866 06 08</a>	14	0.011		
		10		<a href="#">1866 06 10</a>	19	0.028		
	8	12		<a href="#">1866 06 12</a>	22	0.040		
		10		<a href="#">1866 08 10</a>	19	0.026		
	10	12		<a href="#">1866 08 12</a>	22	0.037		
		16		<a href="#">1866 08 16</a>	27	0.071		
	12	12		<a href="#">1866 10 12</a>	22	0.034		
		16		<a href="#">1866 10 16</a>	27	0.065		
		16		<a href="#">1866 12 16</a>	27	0.061		

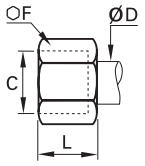

## 1824 Stainless Steel Olive

	Stainless steel 316L			<b>ØD</b>		<b>kg</b>
	6	<a href="#">1824 06 00</a>		0.001		
	8	<a href="#">1824 08 00</a>		0.001		
	10	<a href="#">1824 10 00</a>		0.003		
	12	<a href="#">1824 12 00</a>		0.004		
	16	<a href="#">1824 16 00</a>		0.005		

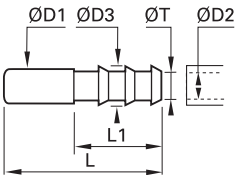

## 1810 Stainless Steel Nut

	Stainless steel 316L			<b>ØD</b>	<b>C</b>		<b>F</b>	<b>L</b>	<b>kg</b>
	6	M10x1		<a href="#">1810 06 00</a>	13	11	0.007		
	8	M12x1		<a href="#">1810 08 00</a>	14	13	0.008		
	10	M16x1.5		<a href="#">1810 10 00</a>	19	15	0.017		
	12	M18x1.5		<a href="#">1810 12 00</a>	22	15	0.024		
	16	M22x1.5		<a href="#">1810 16 00</a>	27	17	0.041		

## 1822 Barb Adaptor for Hose

	Stainless steel 316L			<b>ØD1</b>	<b>ØD2</b>		<b>ØD3</b>	<b>L</b>	<b>L1</b>	<b>ØT min</b>	<b>kg</b>
	6	7		<a href="#">1822 06 07</a>	9	37.5	22.5	6	0.006		
		6		<a href="#">1822 08 06</a>	8	40	22.5	5	0.007		
	8	7		<a href="#">1822 08 07</a>	9	40	22.5	6	0.007		
		10		<a href="#">1822 08 10</a>	12.5	40	22.5	9	0.011		
	10	7		<a href="#">1822 10 07</a>	9	43	22.5	6	0.009		
		10		<a href="#">1822 10 10</a>	12.5	43	22.5	9	0.013		
	12	10		<a href="#">1822 12 10</a>	12.2	43	22.5	9	0.012		
		13		<a href="#">1822 12 13</a>	15	50	29.5	13	0.016		

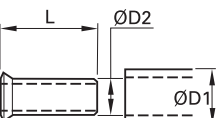
## 1827 Stainless Steel Tube Support

	Stainless steel 316L			<b>ØD1</b>	<b>ØD2</b>		<b>L</b>	<b>kg</b>
	6	4		<a href="#">1827 06 00</a>	11.5	0.001		
	8	6		<a href="#">1827 08 00</a>	14	0.001		
	10	8		<a href="#">1827 10 00</a>	18	0.001		
	12	9		<a href="#">1827 12 09</a>	18	0.001		
	16	10		<a href="#">1827 12 00</a>	18	0.001		

This tube support is necessary when using fluoropolymer tubing at all temperatures compatible with the fitting/tubing assembly.

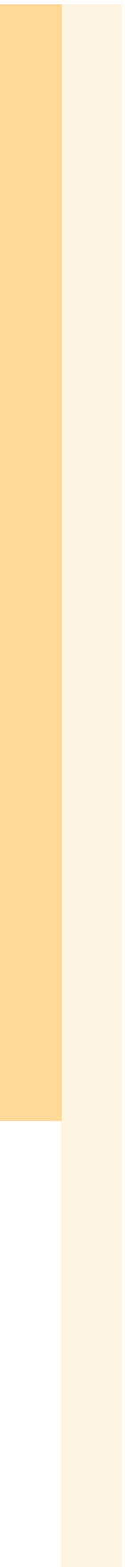

# PL Nickel-Plated Brass Spigot Fitting Range

## PL Nickel-Plated Brass Spigot Fittings

### Stud Fittings

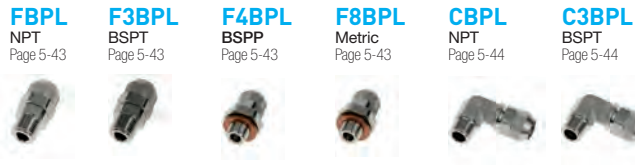

### Banjo Fitting

**COR4BPL**  
BSP  
Page 5-45



### Tube-to-Tube Fittings

<b>HBPL</b> Connector Page 5-46	<b>JBPL</b> Connector Page 5-46	<b>WBPL</b> Bulkhead Connector Page 5-46
---------------------------------------	---------------------------------------	---



### Complementary Fitting

**BPLM**  
Nut  
Page 5-46



# PL Nickel-Plated Brass Spigot Fittings

This range of Parker Legris has a sealing system which guarantees **excellent sealing and full flow**. PL fittings for flexible tubing are **fully re-usable**. They provide excellent compatibility with a wide variety of fluids.

## Product Advantages

### Rapid Assembly

- Nut design allows hand tightening with soft tubing (PU, PE etc.)
- Quick to assemble and disassemble
- Compatible with all flexible tubes of hardness up to 90 shore A (polyurethane, polyamide, polyethylene, fluoropolymers, etc.)
- Mechanical stop on the body to prevent overtightening

### Performance

- Special spigot design ensures full flow and excellent tensile performance
- Reliable direct sealing system without the use of a seal or olive
- Low and medium pressure
- Nickel-plated for increased corrosion resistance



**Applications**

- Food Process
- Painting
- Pneumatic Systems
- Chemical
- Welding
- Laboratories
- Railway

## Technical Characteristics

<b>Compatible Fluids</b>	Compressed air Other fluids: contact us
<b>Working Pressure</b>	Vacuum to 40 bar
<b>Working Temperature</b>	-40°C to +100°C

<b>Tensile Performance (polyamide tubing)</b>	Ø	2.7/4	4/6	6/8	7.5/10	8/10	10/12	11/14
	daN	11	41	52	88	67	79	149

Reliable performance is dependent upon the type of fluid conveyed, component materials and tubing being used.  
Guaranteed for use with a vacuum of 755 mm Hg (99% vacuum).

### Component Materials

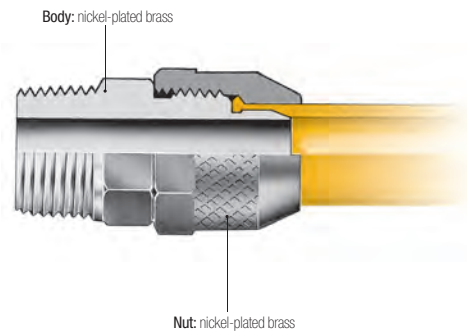

**Silicone-free**

## Installation

### Cutting the Tube



Cut the polymer tube square.

### Preparing the Connection

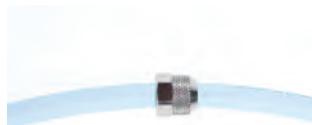

Slide the nut onto the tube.

### Connecting the Tube



Push the tube home into the body of the fitting.



### Final Assembly



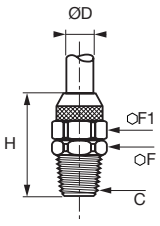

Tighten the nut by hand (in the case of soft tubing) or using a spanner (for semi-rigid tubing) until it comes into contact with the end stop.

# Stud Fittings

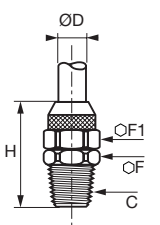

## FBPL Stud Fitting, Male NPT Thread

	Nickel-plated brass 	<b>ØD</b>	<b>C</b>		<b>F</b>	<b>F1</b>	<b>H</b>	<b>kg</b>
		2.7x4	NPT1/8	<a href="#">FBPL2.7/4-1/8</a>	11	8	22	0.011
		4x6	NPT1/8	<a href="#">FBPL4/6-1/8</a>	11	11	25	0.016
		4x6	NPT1/4	<a href="#">FBPL4/6-1/4aV</a>	11	11	29	0.026
		6x8	NPT1/8	<a href="#">FBPL6/8-1/8</a>	14	13	25	0.016
		6x8	NPT1/4	<a href="#">FBPL6/8-1/4</a>	12	13	29	0.023
		8x10	NPT1/4	<a href="#">FBPL8/10-1/4</a>	14	16	30	0.031
		8x10	NPT3/8	<a href="#">FBPL8/10-3/8</a>	14	16	31	0.040
		10x12	NPT3/8	<a href="#">FBPL10/12-3/8</a>	14	17	33	0.040

## F3BPL Stud Fitting, Male BSPT Thread

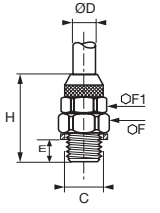

	Nickel-plated brass 	<b>ØD</b>			<b>F</b>	<b>F1</b>	<b>H</b>	<b>kg</b>
		2.7x4	R1/8	<a href="#">F3BPL2.7/4-1/8</a>	10	8	20.5	0.009
		4x6	R1/8	<a href="#">F3BPL4/6-1/8</a>	10	11	23.5	0.016
		4x6	R1/4	<a href="#">F3BPL4/6-1/4</a>	14	11	26.5	0.025
		6x8	R1/8	<a href="#">F3BPL6/8-1/8</a>	12	13	23.5	0.015
		6x8	R1/4	<a href="#">F3BPL6/8-1/4</a>	14	13	26.5	0.023
		6x8	R3/8	<a href="#">F3BPL6/8-3/8</a>	17	13	27.6	0.026
		7.5x10	R1/4	<a href="#">F3BPL7.5/10-1/4</a>	14	16	27.5	0.031
		7.5x10	R3/8	<a href="#">F3BPL7.5/10-3/8</a>	17	16	28.6	0.037
		8x10	R1/4	<a href="#">F3BPL8/10-1/4</a>	14	16	27.5	0.031
		8x10	R3/8	<a href="#">F3BPL8/10-3/8</a>	17	16	28.6	0.043
		10x12	R3/8	<a href="#">F3BPL10/12-3/8</a>	17	17	30.1	0.036
		11x14	R3/8	<a href="#">F3BPL11/14-3/8</a>	19	22	32.5	0.058

## F4BPL Stud Fitting, Male BSPP Thread

	Nickel-plated brass 	<b>ØD</b>	<b>C</b>		<b>E</b>	<b>F</b>	<b>F1</b>	<b>H</b>	<b>kg</b>
		4x6	G1/8	<a href="#">F4BPL4/6-1/8</a>	8	14	11	26	0.021
		6x8	G1/4	<a href="#">F4BPL6/8-1/4</a>	9	17	13	28	0.030

These fittings are supplied with a copper seal.

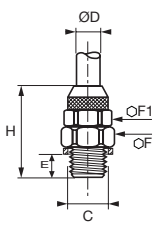
## F8BPL Stud Fitting, Male Metric Straight Thread

	Nickel-plated brass 	<b>ØD</b>	<b>C</b>		<b>E</b>	<b>F</b>	<b>F1</b>	<b>H</b>	<b>kg</b>
		6x8	M10x1	<a href="#">F8BPL6/8M10</a>	7	14	13	28	0.021
		6x8	M12x1.25	<a href="#">F8BPL6/8M12</a>	7	17	13	28	0.024

These fittings are supplied with a copper seal.

### Fitting Dimensions

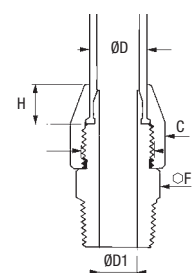

D: Tube O.D. (mm)	C: Metric Thread	D1: Bore Diameter (mm)	F: Hex (mm)	H: Tube Insertion Length (mm)
4x2.7	M6x0.75	1.5	8	4.5
6x4	M9x0.75	3	11	6.5
8x6	M11x0.75	5	13	6.5
10x7.5	M13x1	6.5	17	7
10x8	M13x1	6.5	17	7
12x10	M15x1.25	9	17	7.5
14x11	M18x1.50	9.5	22	8.5



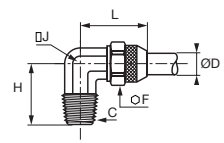

PL Nickel-Plated Brass Spigot Fittings

# Stud Fittings

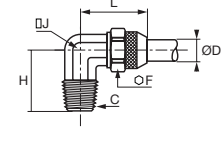

## CBPL Stud Elbow, Male NPT Thread

	Nickel-plated brass		<b>ØD</b>	<b>C</b>		<b>F</b>	<b>H</b>	<b>J</b>	<b>L</b>	<b>kg</b>
			2.7x4	NPT1/8	<a href="#">CBPL2.7/4-1/8</a>	8	18	8	22	0.019
			4x6	NPT1/8	<a href="#">CBPL4/6-1/8</a>	11	18	8	24	0.023
			4x6	NPT1/4	<a href="#">CBPL4/6-1/4</a>	11	23	10	25	0.036
			6x8	NPT1/8	<a href="#">CBPL6/8-1/8</a>	13	19	10	25	0.027
			6x8	NPT1/4	<a href="#">CBPL6/8-1/4</a>	13	23	10	25	0.034
			8x10	NPT1/4	<a href="#">CBPL8/10-1/4</a>	16	24	12	28	0.058
			8x10	NPT3/8	<a href="#">CBPL8/10-3/8</a>	16	25	12	28	0.059
			10x12	NPT3/8	<a href="#">CBPL10/12-3/8</a>	17	27	14	32	0.051

## C3BPL Stud Elbow, Male BSPT Thread

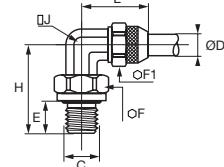

	Nickel-plated brass		<b>ØD</b>	<b>C</b>		<b>F</b>	<b>H</b>	<b>J</b>	<b>L</b>	<b>kg</b>
			2.7x4	R1/8	<a href="#">C3BPL2.7/4-1/8</a>	8	17	8	22	0.018
			4x6	R1/8	<a href="#">C3BPL4/6-1/8</a>	11	17	8	24	0.022
			4x6	R1/4	<a href="#">C3BPL4/6-1/4</a>	11	21.5	10	25	0.031
			6x8	R1/8	<a href="#">C3BPL6/8-1/8</a>	13	18	10	25	0.025
			6x8	R1/4	<a href="#">C3BPL6/8-1/4</a>	13	21.5	10	25	0.031
			6x8	R3/8	<a href="#">C3BPL6/8-3/8</a>	13	23.1	12	27	0.050
			7.5x10	R1/4	<a href="#">C3BPL7.5/10-1/4</a>	16	22.5	12	28	0.057
			7.5x10	R3/8	<a href="#">C3BPL7.5/10-3/8</a>	16	23.1	12	28	0.058
			8x10	R1/4	<a href="#">C3BPL8/10-1/4</a>	16	21.5	12	28	0.057
			8x10	R3/8	<a href="#">C3BPL8/10-3/8</a>	16	23.1	12	28	0.058
			10x12	R3/8	<a href="#">C3BPL10/12-3/8</a>	17	25.1	14	32	0.052
			11x14	R3/8	<a href="#">C3BPL11/14-3/8</a>	22	25.1	16	34	0.094

## C4BPL Stud Elbow, Male BSPP Thread

	Nickel-plated brass, NBR		<b>ØD</b>	<b>C</b>		<b>E</b>	<b>F</b>	<b>F1</b>	<b>H</b>	<b>J</b>	<b>L</b>	<b>kg</b>
			6x8	G1/4	<a href="#">C4BPL6/8-1/4</a>	7	13	13	27	12	27	0.063

These fittings are supplied with nitrile seals.

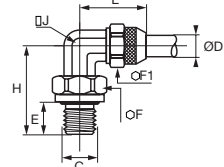

## C8BPL Stud Elbow, Male Metric Straight Thread

	Nickel-plated brass, NBR		<b>ØD</b>	<b>C</b>		<b>E</b>	<b>F</b>	<b>F1</b>	<b>H</b>	<b>J</b>	<b>L</b>	<b>kg</b>
			6x8	M10x1	<a href="#">C8BPL6/8M10</a>	7	14	13	27.25	10	21.5	0.031
			6x8	M12x1	<a href="#">C8BPL6/8M12</a>	7	13	13	26	12	25	0.063

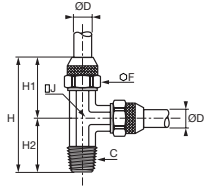

These fittings are supplied with nitrile seals.

# Stud Fittings

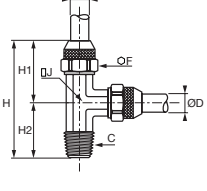

## RBPL Stud Run Tee, Male NPT Thread

	Nickel-plated brass 	<b>ØD</b>	<b>C</b>		<b>F</b>	<b>H</b>	<b>H1</b>	<b>H2</b>	<b>J</b>	<b>kg</b>
		4x6	NPT1/8	<a href="#">RBPL4/6-1/8</a>	11	42	24	18	8	0.037
		4x6	NPT1/4	<a href="#">RBPL4/6-1/4</a>	11	48	25	23	10	0.050
		6x8	NPT1/4	<a href="#">RBLP6/8-1/4</a>	13	48	25	23	10	0.046

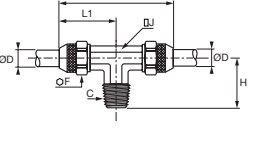

## R3BPL Stud Run Tee, Male BSPT Thread

	Nickel-plated brass 	<b>ØD</b>	<b>C</b>		<b>F</b>	<b>H</b>	<b>H1</b>	<b>H2</b>	<b>J</b>	<b>kg</b>
		4x6	R1/8	<a href="#">R3BPL4/6-1/8</a>	11	42	24	17	8	0.035
		4x6	R1/4	<a href="#">R3BPL4/6-1/4</a>	11	48	25	21.5	10	0.048
		6x8	R1/8	<a href="#">R3BPL6/8-1/8</a>	13	44	25	18	10	0.037
		6x8	R1/4	<a href="#">R3BLP6/8-1/4</a>	13	48	25	21.5	10	0.045

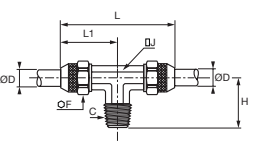

## SBPL Stud Branch Tee, Male NPT Thread

	Nickel-plated brass 	<b>ØD</b>	<b>C</b>		<b>F</b>	<b>H</b>	<b>J</b>	<b>L</b>	<b>L1</b>	<b>kg</b>
		4x6	NPT1/8	<a href="#">SBPL4/6-1/8</a>	11	18	8	48	24	0.035
		4x6	NPT1/4	<a href="#">SBPL4/6-1/4</a>	11	23	10	50	25	0.050
		6x8	NPT1/4	<a href="#">SBPL6/8-1/4</a>	13	23	10	50	25	0.049

## S3BPL Branch Tee, Male BSPT Thread

	Nickel-plated brass 	<b>ØD</b>	<b>C</b>		<b>F</b>	<b>H</b>	<b>J</b>	<b>L</b>	<b>L1</b>	<b>kg</b>
		4x6	R1/8	<a href="#">S3BPL4/6-1/8</a>	11	17	8	48	24	0.035
		4x6	R1/4	<a href="#">S3BPL4/6-1/4</a>	11	21.5	10	50	25	0.048
		6x8	R1/8	<a href="#">S3BPL6/8-1/8</a>	13	18	10	50	25	0.037
		6x8	R1/4	<a href="#">S3BLP6/8-1/4</a>	13	21.5	10	50	25	0.045

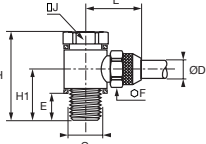

## COR4BPL Single Banjo, Male BSPP Thread

	Nickel-plated brass 	<b>ØD</b>	<b>C</b>		<b>E</b>	<b>F</b>	<b>F1</b>	<b>H</b>	<b>H1</b>	<b>L</b>	<b>kg</b>
		4x6	G1/8	<a href="#">COR4BPL4/6-1/8</a>	7	14	11	27	16	24	0.068
		4x6	G1/4	<a href="#">COR4BPL4/6-1/4</a>	8	19	11	29	17	26	0.096
		6x8	G1/8	<a href="#">COR4BPL6/8-1/8</a>	7	14	13	27	16	25	0.068
		6x8	G1/4	<a href="#">COR4BLP6/8-1/4</a>	8	19	13	30	17	27	0.096

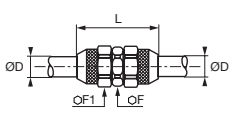

These parts are supplied with peripheral seals.  
The banjo bolt is made of steel.

# PL Tube-to-Tube and Complementary Fittings

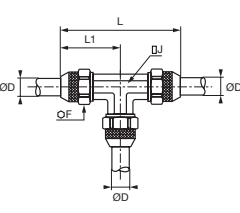

## HBPL Equal Tube-to-Tube Connector

	Nickel-plated brass 	<b>ØD</b>		<b>F</b>	<b>F1</b>	<b>L</b>	<b>kg</b>
		2.7x4	<a href="#">HBPL2.7/4</a>	7	8	24	0.010
		4x6	<a href="#">HBPL4/6</a>	10	11	30	0.021
		6x8	<a href="#">HBPL6/8</a>	12	13	30	0.022
		8x10	<a href="#">HBPL8/10</a>	14	16	32	0.043
		10x12	<a href="#">HBPL10/12</a>	16	17	36	0.056
		11x14	<a href="#">HBPL11/14</a>	19	22	40	0.087

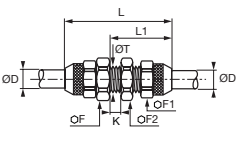

## JBPL Equal Tee

	Nickel-plated brass 	<b>ØD</b>		<b>F</b>	<b>J</b>	<b>L</b>	<b>L1</b>	<b>kg</b>
		2.7x4	<a href="#">JBPL2.7/4</a>	8	8	44	22	0.024
		4x6	<a href="#">JBPL4/6</a>	11	8	48	24	0.042
		6x8	<a href="#">JBPL6/8</a>	13	10	50	25	0.045
		7.5x10	<a href="#">JBPL7.5/10</a>	16	12	56	28	0.086
		8x10	<a href="#">JBPL8/10</a>	16	12	56	28	0.085
		10x12	<a href="#">JBPL10/12</a>	17	14	64	32	0.100
		11x14	<a href="#">JBPL11/14</a>	22	16	68	34	0.168

## WBPL Equal Bulkhead Connector

	Nickel-plated brass 	<b>ØD</b>		<b>F</b>	<b>F1</b>	<b>F2</b>	<b>K<sub>max</sub></b>	<b>L</b>	<b>L1</b>	<b>T<sub>min</sub></b>	<b>kg</b>
		4x6	<a href="#">WBPL4/6</a>	13	11	13	5	39	22	M9x0.75	0.030
		6x8	<a href="#">WBPL6/8</a>	14	13	16	5	39	22	M11x0.75	0.032
		8x10	<a href="#">WBPL8/10</a>	16	16	17	5	43	24	M13x1	0.057
		10x12	<a href="#">WBPL10/12</a>	19	17	19	5	46	26	M15x1.25	0.064
		11x14	<a href="#">WBPL11/14</a>	22	22	22	5	50	28	M18x1.5	0.112

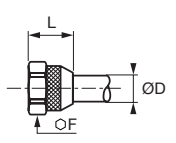
## BPLM Nut

	Nickel-plated brass 	<b>ØD</b>	<b>C</b>		<b>F</b>	<b>L</b>	<b>kg</b>
		2.7x4	M6x0.75	<a href="#">BPL4M</a>	8	10	0.003
		4x6	M9x0.75	<a href="#">BPL6M</a>	11	13	0.006
		6x8	M11x0.75	<a href="#">BPL8M</a>	13	13	0.008
		7.5x10	M13x1	<a href="#">BPL10M</a>	16	14	0.014
		8x10	M13x1	<a href="#">BPL10M</a>	16	14	0.014
		10x12	M15x1.25	<a href="#">BPL12M</a>	17	16	0.012
		11x14	M18x1.5	<a href="#">BPL14M</a>	22	18	0.025

