

DETAILS

Product Number	CA11663_HEIDI-RS
Family	Heidi
Type	Assembly
Color	clear
Diameter	21,6 mm
Height	11,7 mm
Style	round
Optic Material	PMMA
Holder Material	
Fastening	pin, tape
Status	ready
ROHS Compliant	Yes
Date Updated	20/01/2014



OPTICAL PROPERTIES

LED	Viewing Angle	Light Beam	Efficiency	cd/lm	Connector
Double Dome (GM2BB)	sim:	Real spot	-	-	-
Oslo Square EC	sim: 12	Real spot	-	sim: 11.750-	
Oslo SSL 80	6 deg	Real spot	90 %	29.400	-
Z5	7 deg	Real spot	93 %	32.700	-
Oslo SSL 150	7 deg	Real spot	93 %	24.700	-
Luxeon C	7 deg	Real spot	92 %	35.550	-
XP-E	8 deg	Real spot	93 %	26.800	-
NCSxx19A	8 deg	Real spot	89 %	19.000	-
XB-D	8 deg	Real spot	91 %	19.700	-
XP-E2	8 deg	Real spot	90 %	38.000	-
XP-G	9 deg	Real spot	93 %	16.600	-
NCSxx19B	9 deg	Real spot	90 %	25.200	-
NVSxx19A	10 deg	Real spot	89 %	13.900	-
XB-H	10 deg	Real spot	90 %	18.300	-
LUXEON TX	10 deg	Real spot	90 %	19.500	-
Fortimo FastFlex LED board 2x8/757 DS 33deg	33 deg	Real spot	92 %	19.000	-
LUXEON T	11 deg	Real spot	92 %	16.300	-
Z5M1/Z5M2	11 deg	Real spot	94 %	17.770	-
XP-G2	11 deg	Real spot	91 %	19.100	-
LH351Z	11 deg	Real spot	89 %	20.700	-
NVSxx19B/NVSxx19C	12 deg	Real spot	92 %	13.900	-

Relative intensity of CA11663_HEIDI-RS_(XB-H)

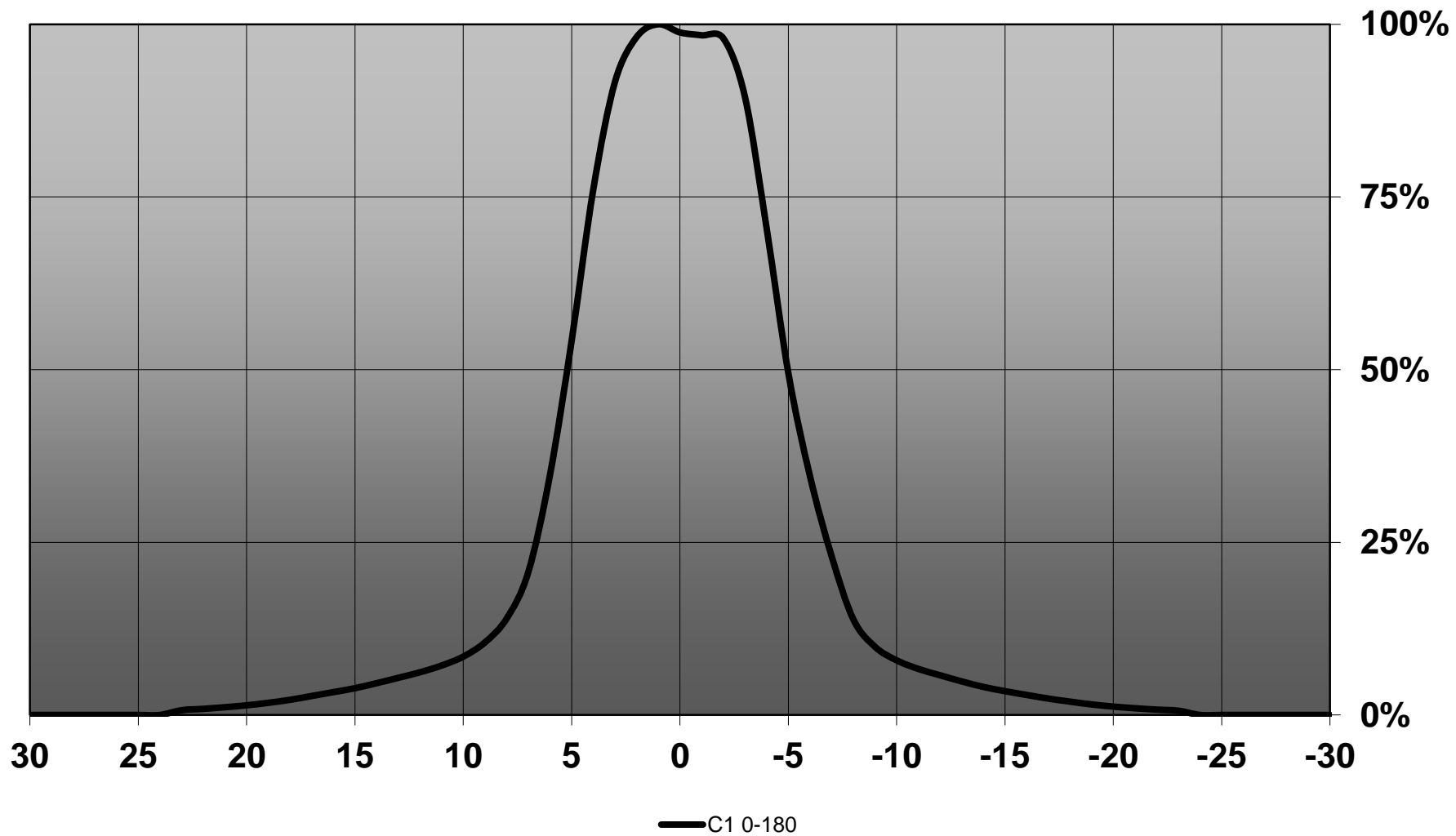

D

C

B

A

4

4

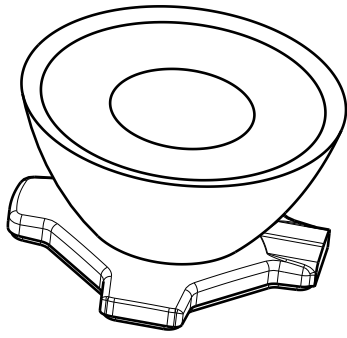

Isometric view

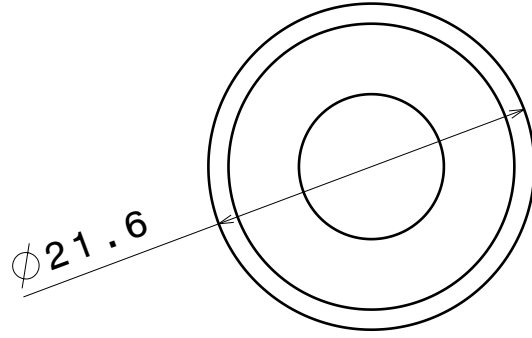

Top view

3

3

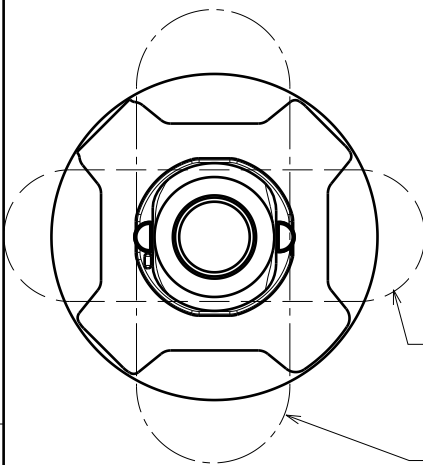

Bottom view
OVAL BEAM direction

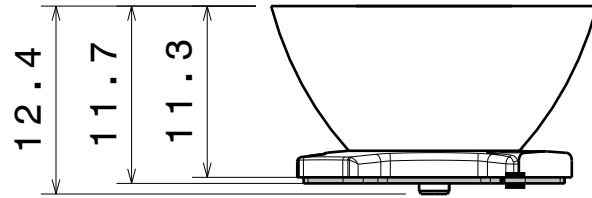

Front view

2

2

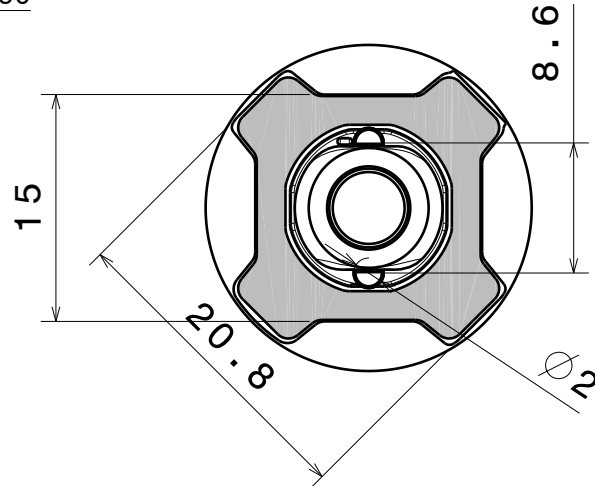

Bottom view

Material:
Lens PMMA
Tape PU Foam

This drawing is our property.
It can't be reproduced
or communicated without
our written agreement.



Ledil Oy
Salorankatu 10
FIN-24100 SALO
Finland

DRAWING TITLE

Datasheet Heidi-Series Assy

DRAWN BY
ah

DATE
1.2.2012

CHECKED BY

DATE

SIZE
A4

DRAWING NUMBER

REV
2

DESIGNED BY

DATE

SCALE 2:1 WEIGHT (g)

SHEET 1/1

D

A

1

1

Ledil Oy CA11663_Heidi-RS-OS CA11663_Heidi-RS-OS / LDC (Linear)

Luminaire: Ledil Oy CA11663_Heidi-RS-OS CA11663_Heidi-RS-OS
Lamps: 1 x Osram Oslon 80 deg white

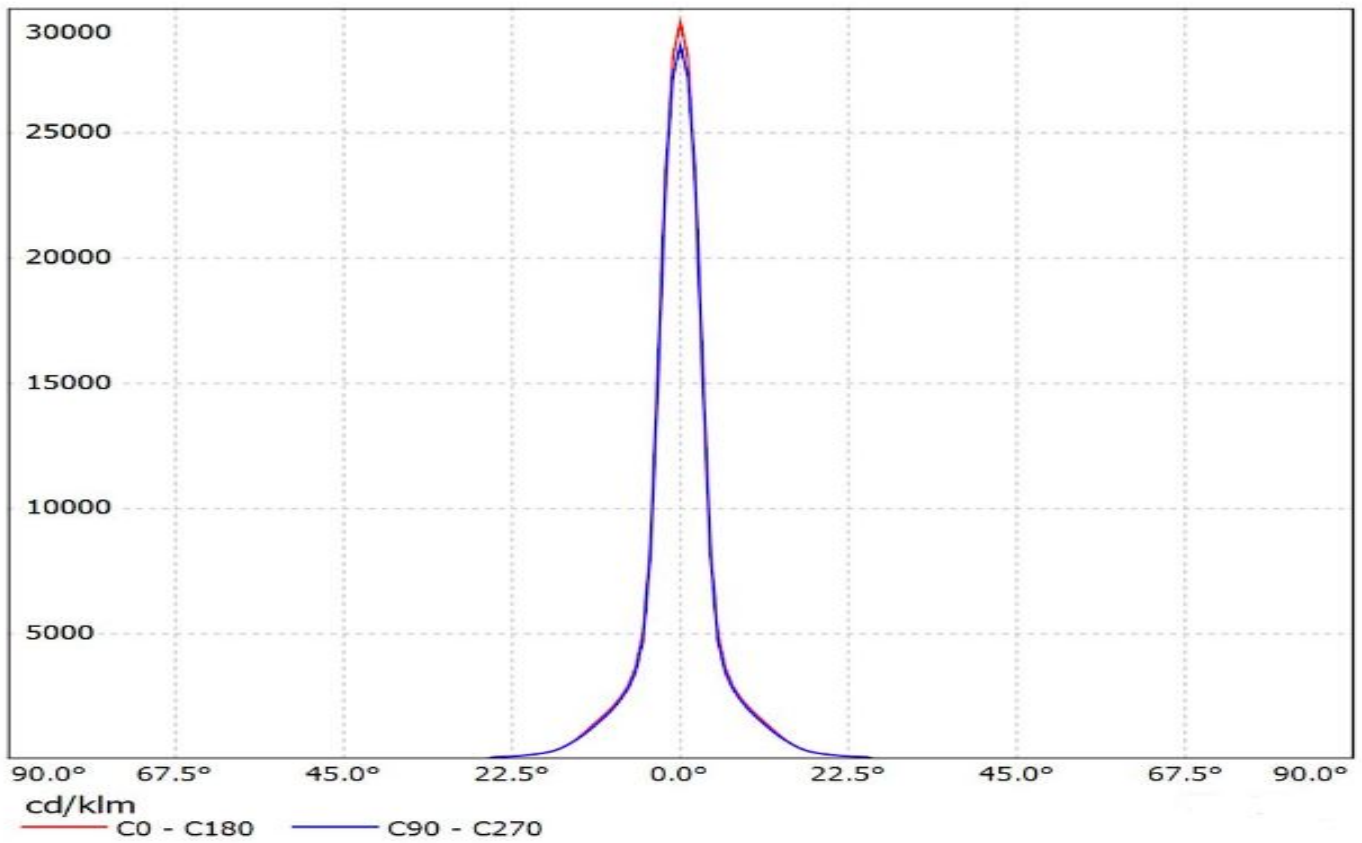

Ledil Oy C11624_GT3-OSL150-WW C11624_GT3-OSL150-WW / LDC (Linear)

Luminaire: Ledil Oy C11624_GT3-OSL150-WW C11624_GT3-OSL150-WW
Lamps: 1 x Osram OSL 150 deg white

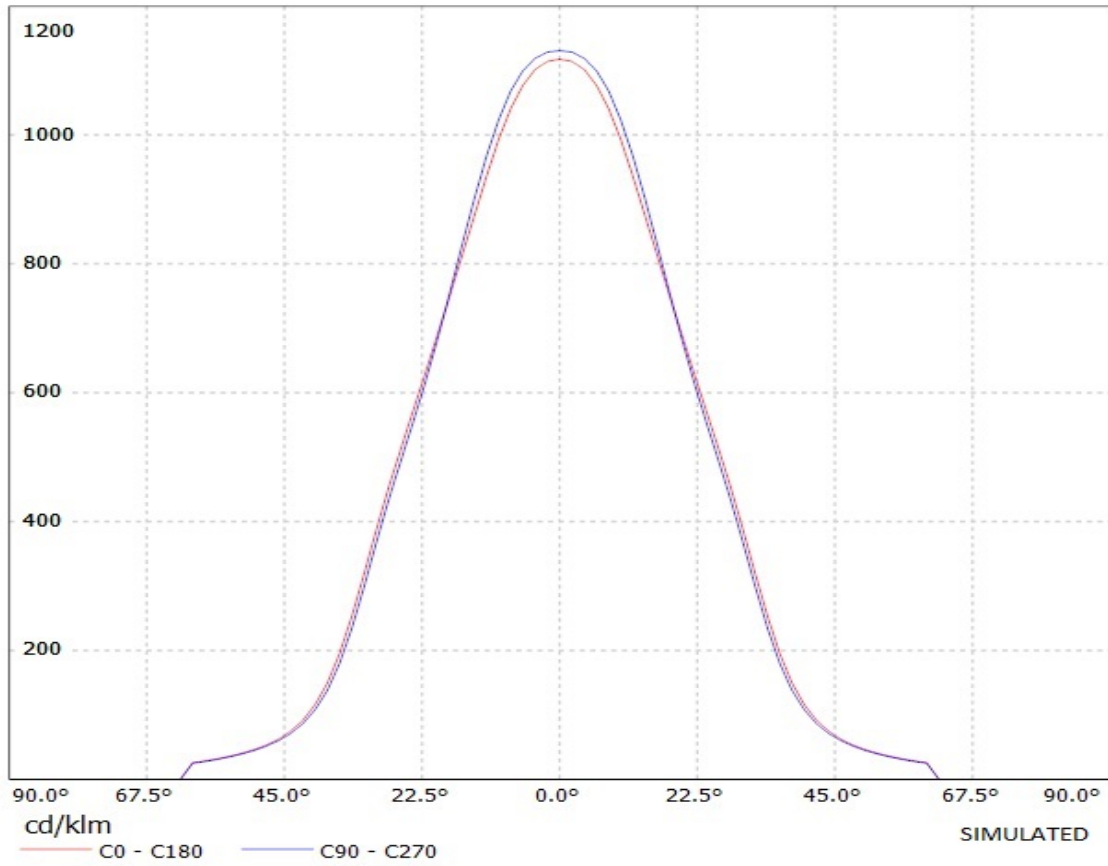

Luminaire: LEDiL Oy CA11663_HEIDI-RS_(Luxeon_C_WHITE)
Lamps: 1 x Luxeon_C_WHITE_84.6969lm@250mA_P=0.7410W_I=0.250A

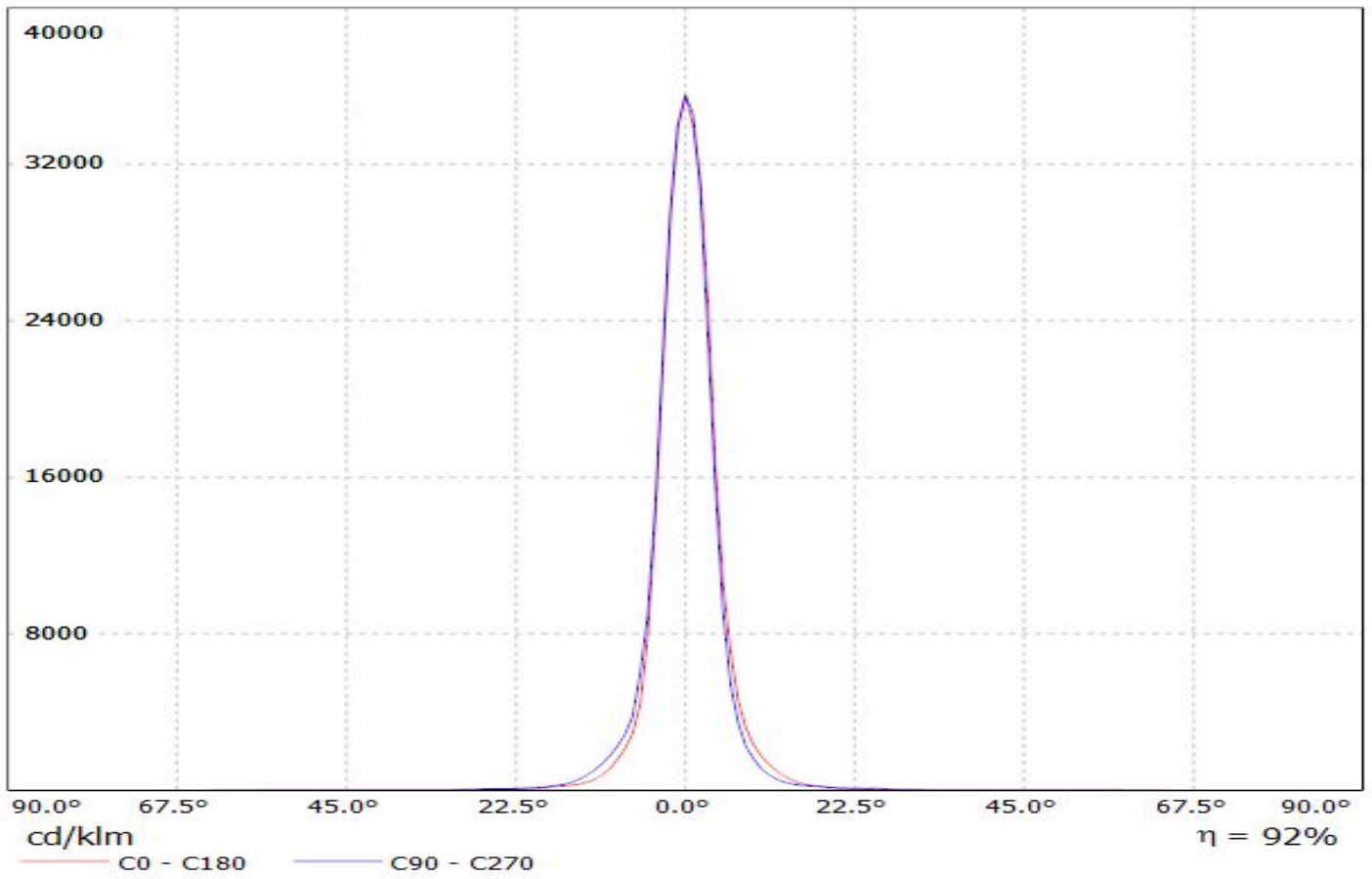

Ledil Oy C11624_GT3-XP-WW C11624_GT3-XP-WW / LDC (Linear)

Luminaire: Ledil Oy C11624_GT3-XP-WW C11624_GT3-XP-WW
Lamps: 1 x Cree XP-E x3 white

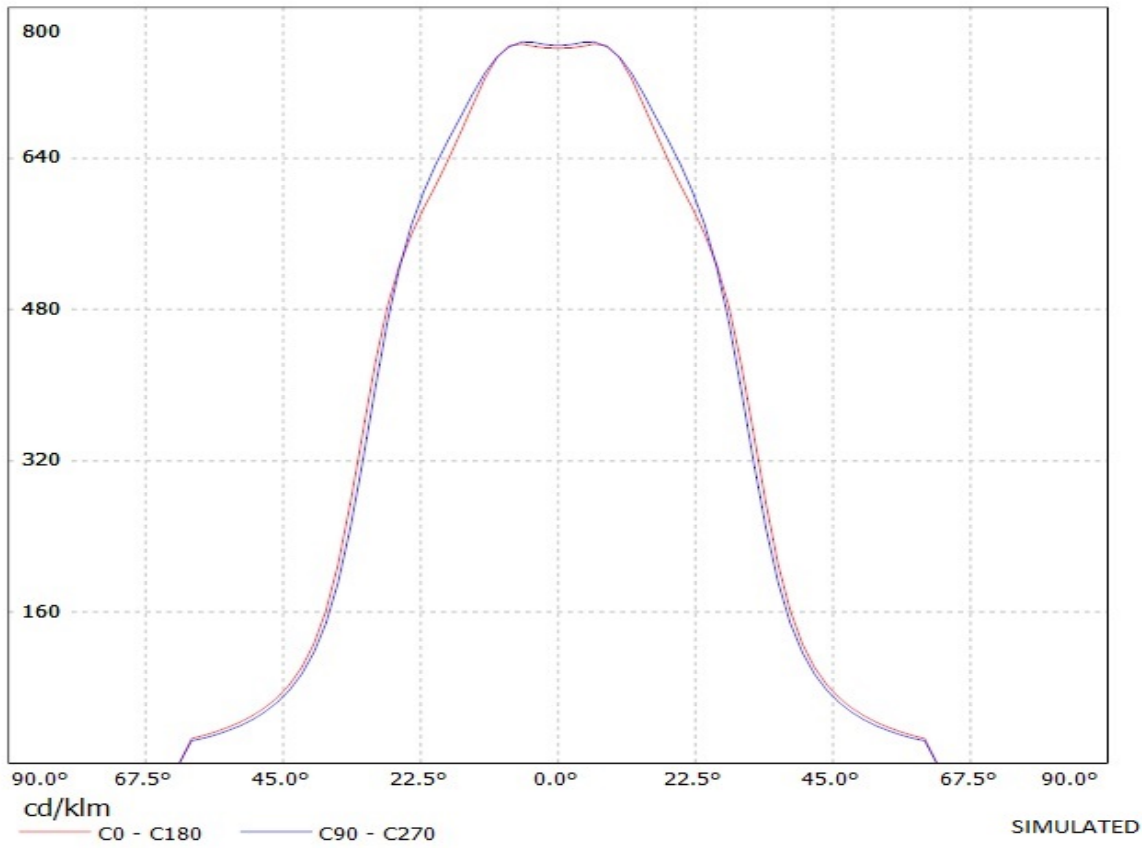

Luminaire: LEDiL Oy CA11663_HEIDI-RS_(XP-E2) Eff. 90%
Lamps: 1 x Cree XP-E2 92lm@250mA CCT:5500K P:0.8W

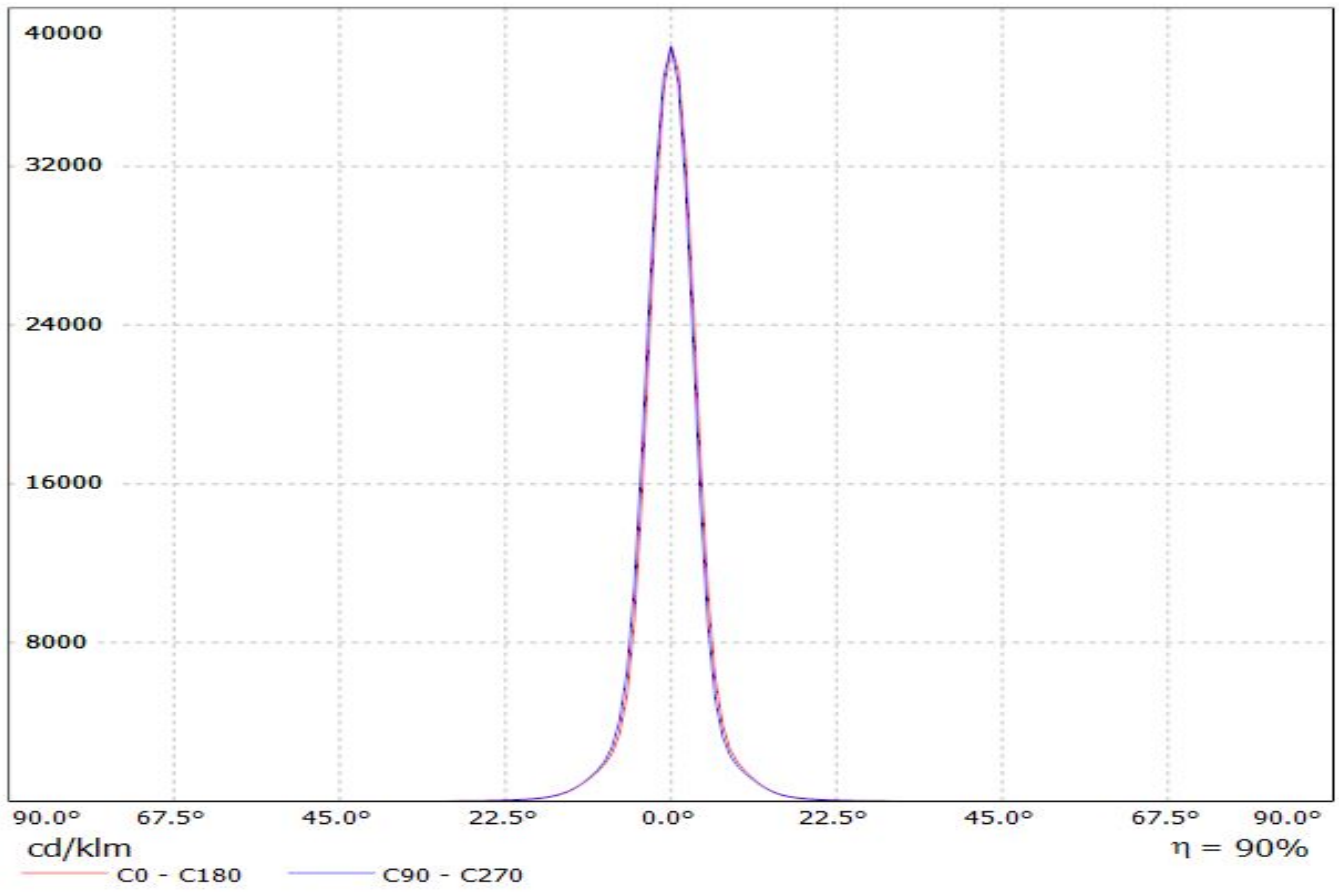

Ledil Oy C11624_GT3-XP-G-WW C11624_GT3-XP-G-WW / LDC (Linear)

Luminaire: Ledil Oy C11624_GT3-XP-G-WW C11624_GT3-XP-G-WW
Lamps: 1 x Cree XP-G x3 white

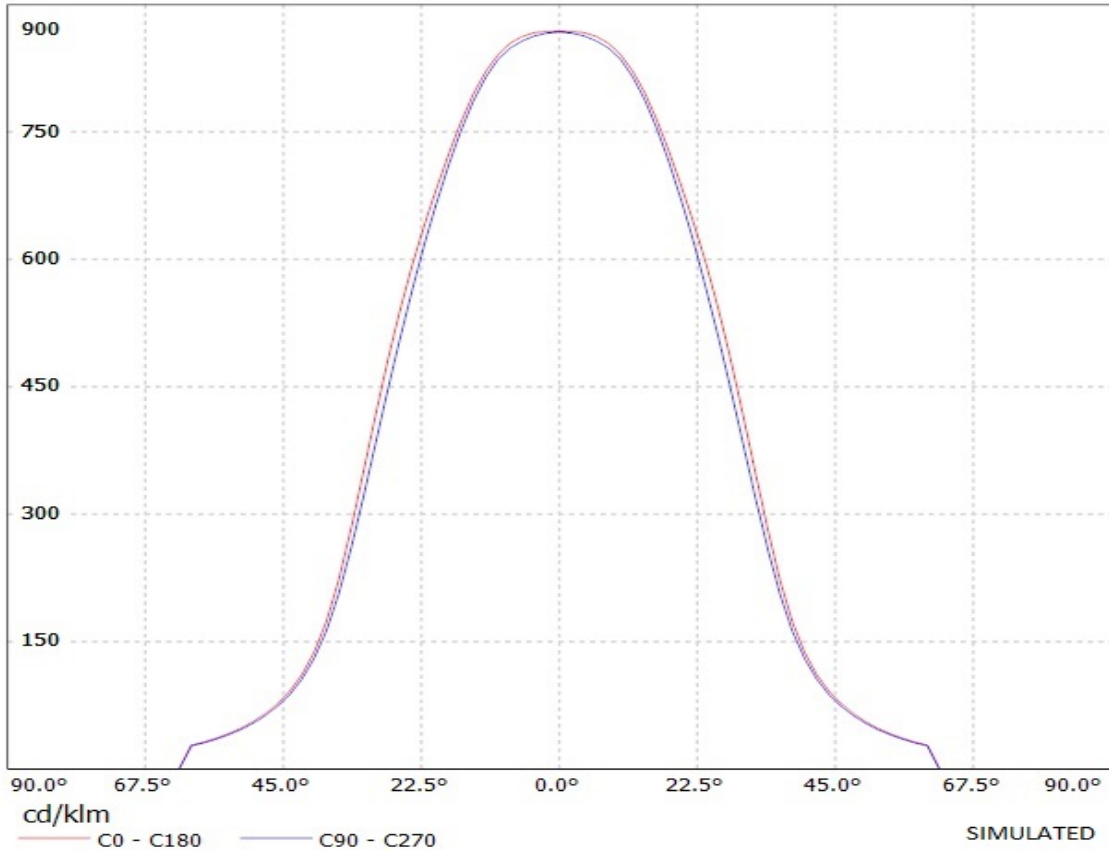

Luminaire: Ledil Oy CA11663_HEIDI-RS_(NCSxx19B) Efficiency=90%
Lamps: 1 x Nichia NCSxx19B (NCSL119BE) 88lm @ 250mA CCT=3000K P=0.8W I=250mA

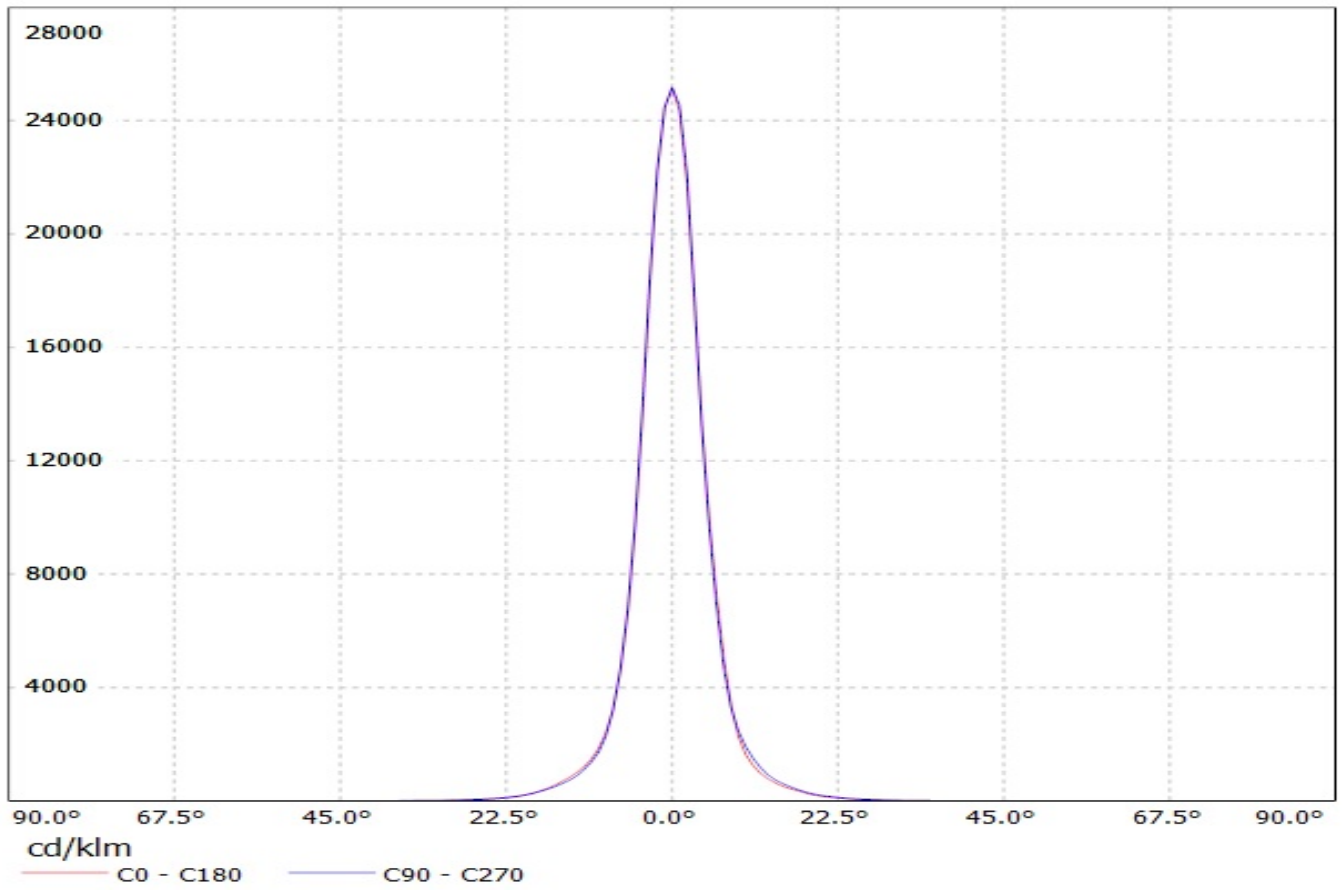

Luminaire: Ledil Oy CA11663_HEIDI-RS_(Luxeon_TX)
Lamps: 1 x Luxeon TX (L1T2-3585) 108lm @ 250mA CCT=3521K P=0.73W I=250mA

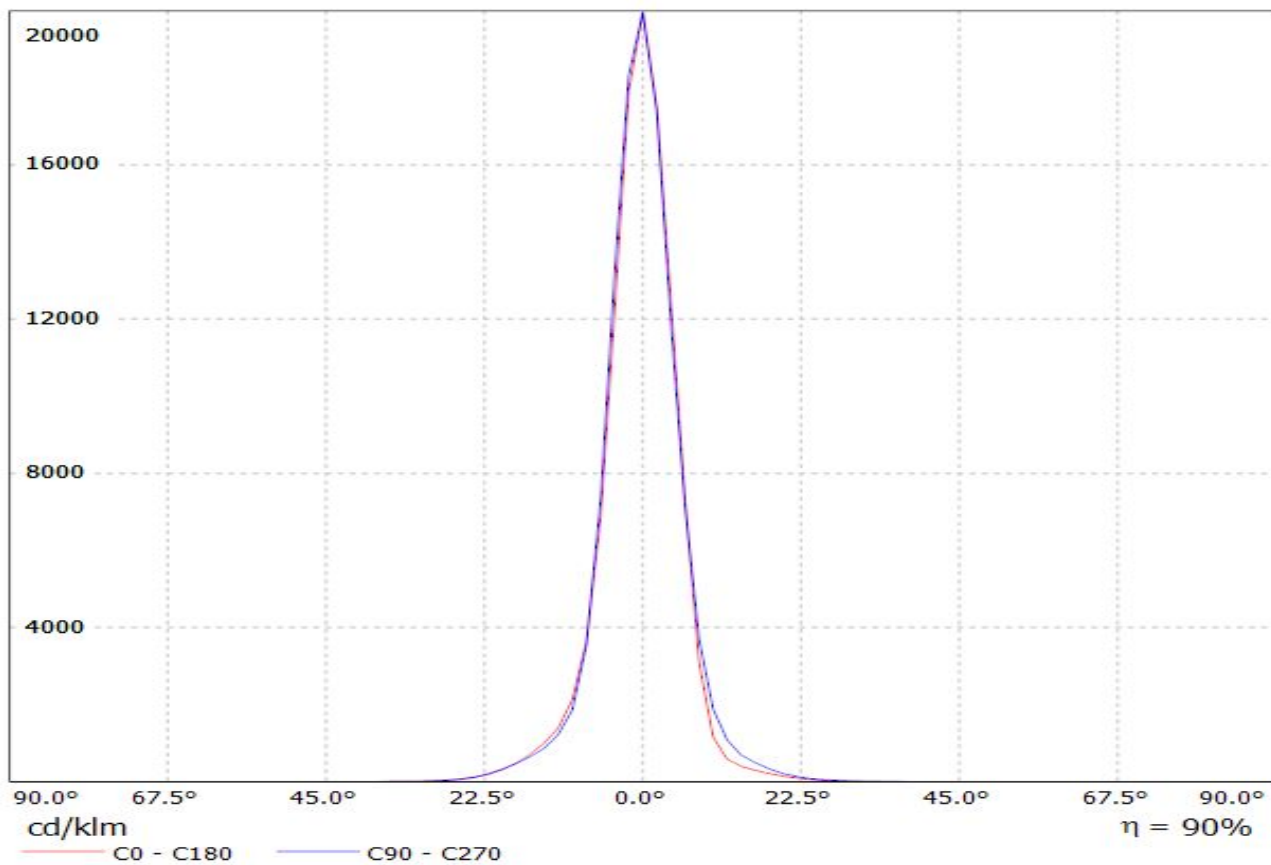

Ledil CA11663_HEIDI-RS_(Fortimo_FastFlex_LED_board 2x8/757_DS_G3) / LDC (Linear)

Luminaire: Ledil CA11663_HEIDI-RS_(Fortimo_FastFlex_LED_board 2x8/757_DS_G3)
Lamps: 1 x Philips_Fortimo_FastFlex_LED_board 2x8/757_DS_G3_(XP-G2)
_3428.78lm@500mA_P=23.7W_I=0.5A

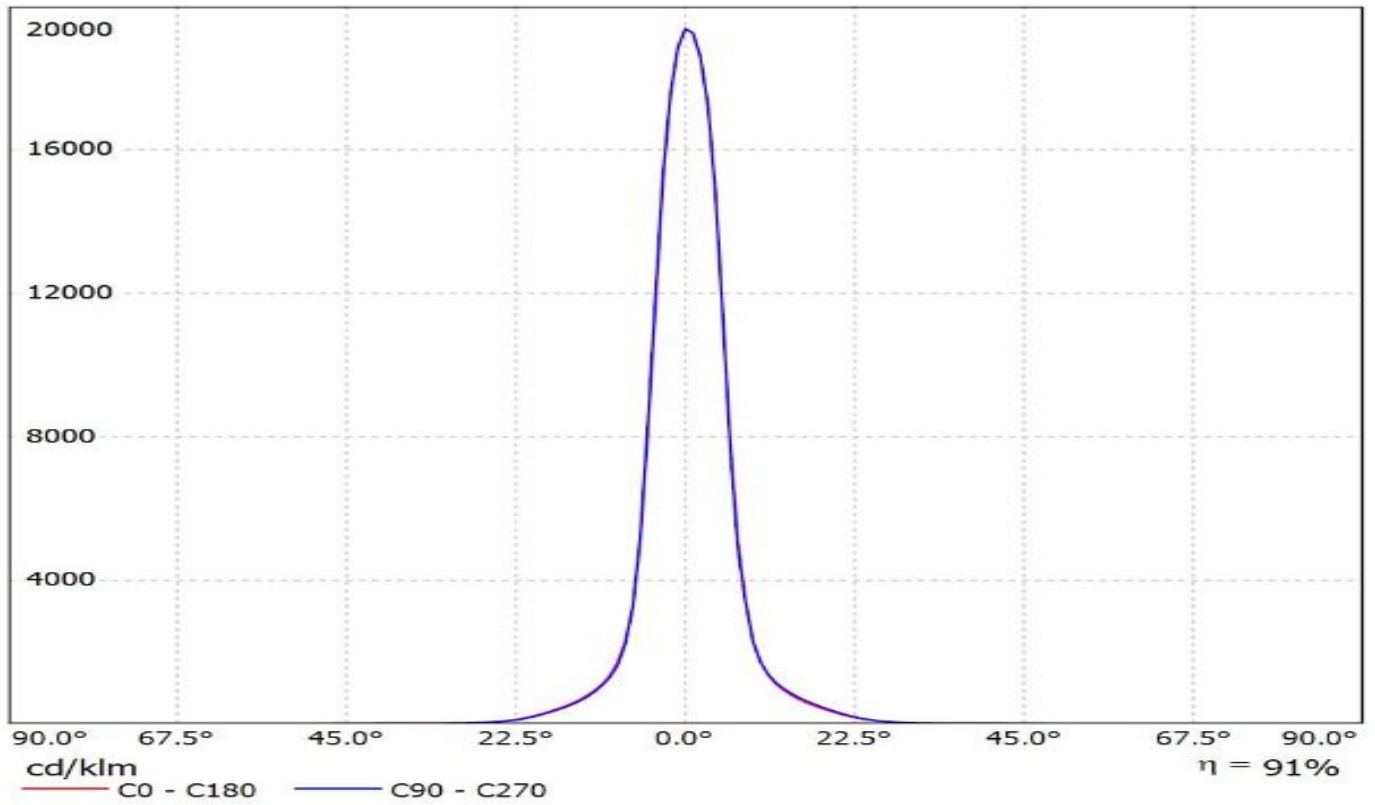

LEDiL Oy CA11663_HEIDI-RS_(LUXEON_T)_1 Eff.91.7% / LDC (Linear)

Luminaire: LEDiL Oy CA11663_HEIDI-RS_(LUXEON_T)_1 Eff.91.7%
Lamps: 1 x LUXEON T (74lm@250mA)

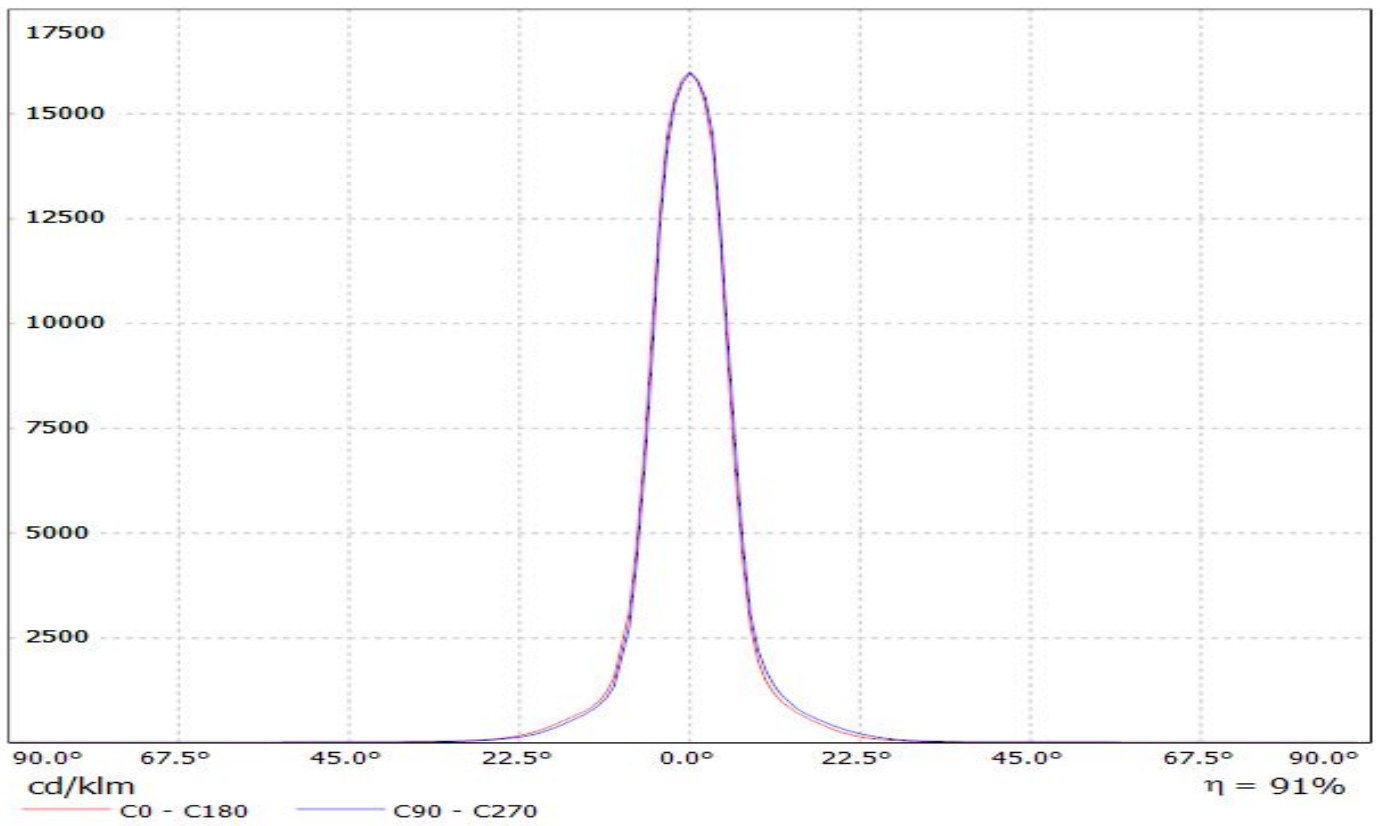

Luminaire: LEDiL Oy CA11663_HEIDI-RS_(Z5M1)

Lamps: 1 x Seoul_Z5M1_107.648lm@250mA_CCT=9074K_P=0.739754W_I=249.9mA

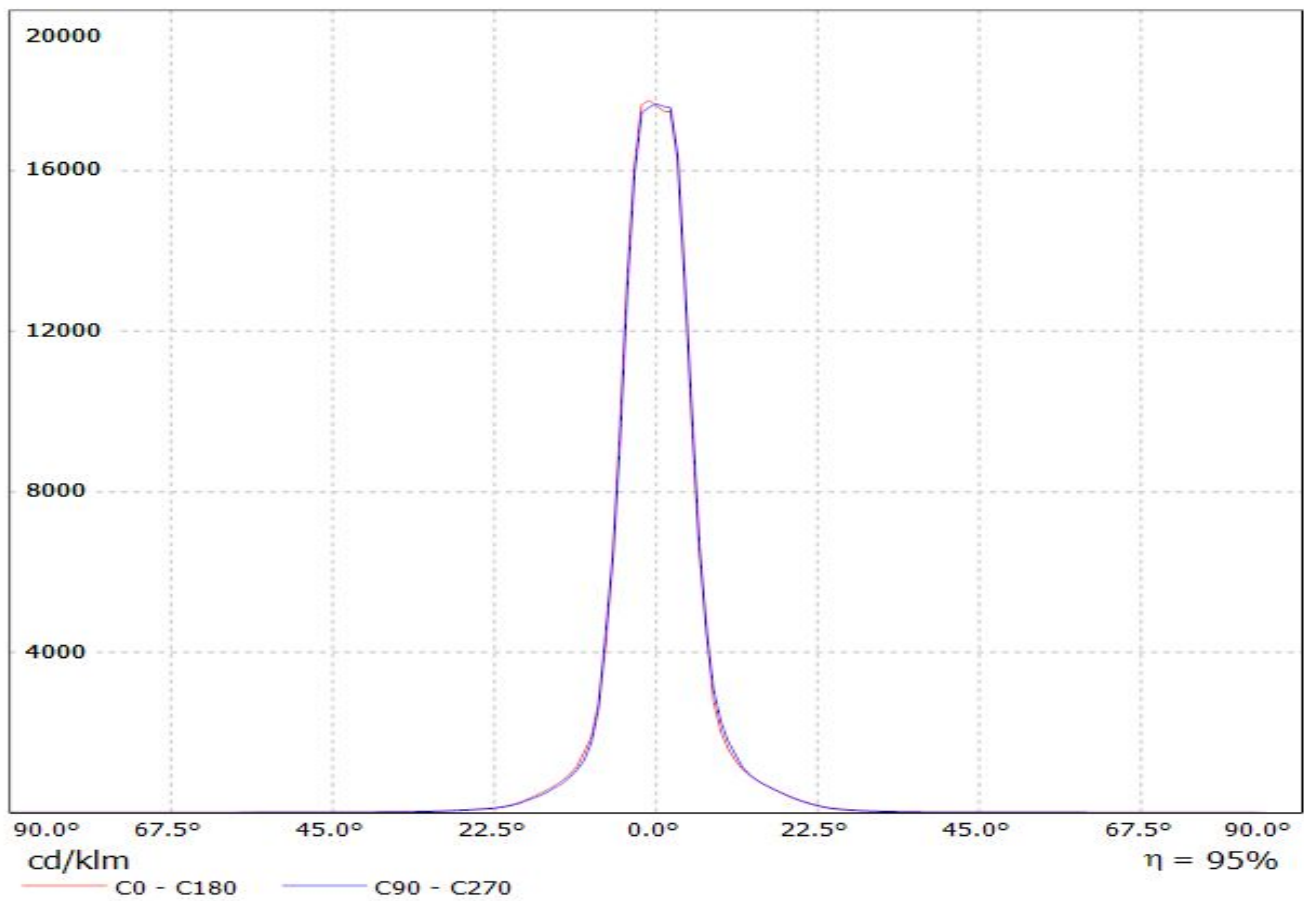

Luminaire: LEDil Oy CA11663_HEIDI-RS_(XP-G2) Efficiency=91%
Lamps: 1 x Cree XP-G2 (XPGBWTL1-0000-00FE4) 100.7lm @ 250mA CCT=4900K P=0.7W I=250mA

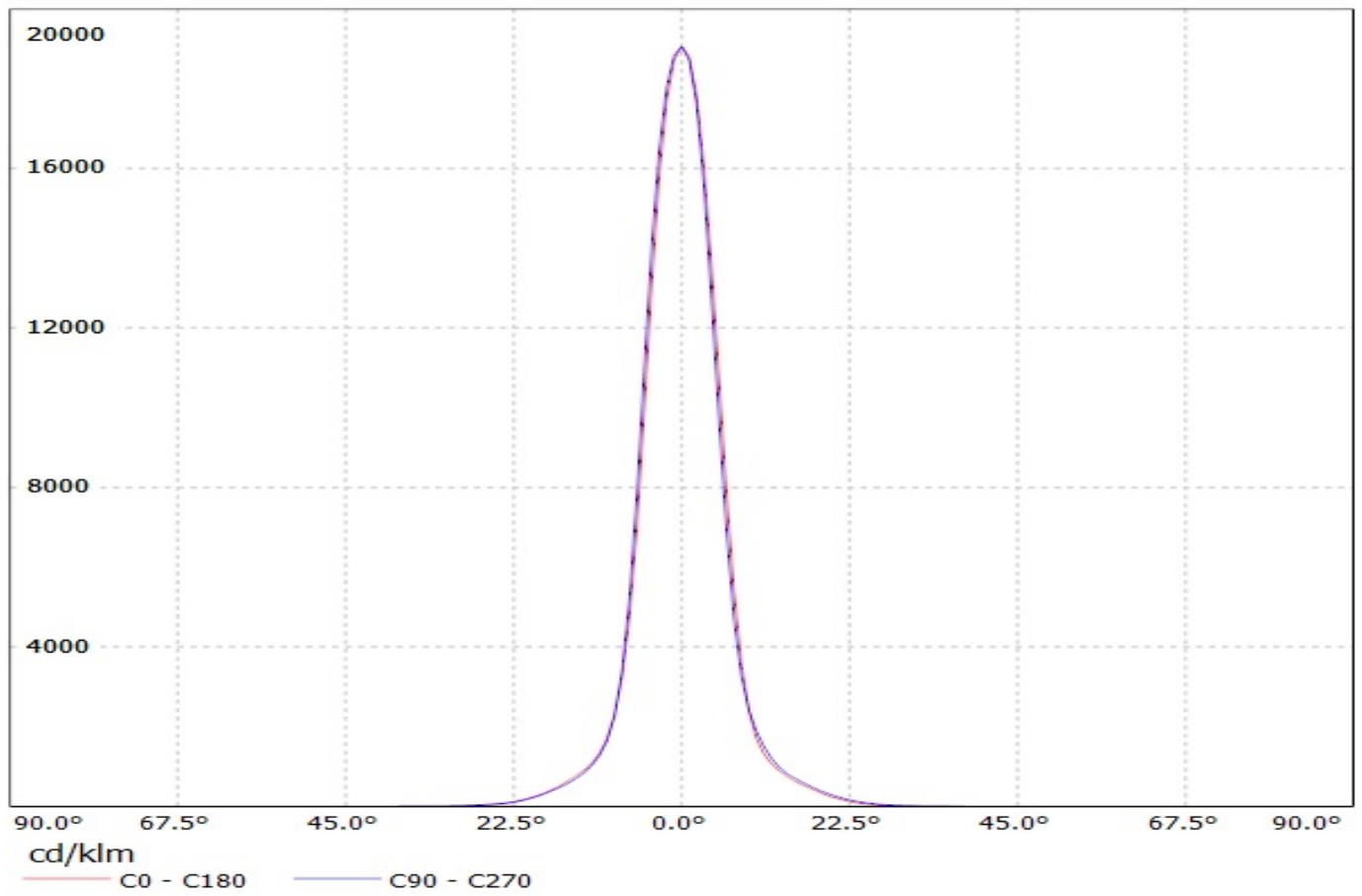

Luminaire: Ledil Oy CA11663_HEIDI-RS_(LH351Z) Efficiency=89%
Lamps: 1 x Samsung LH351Z (90.14lm @ 250mA) CCT=6500K P=0.7W I=250mA

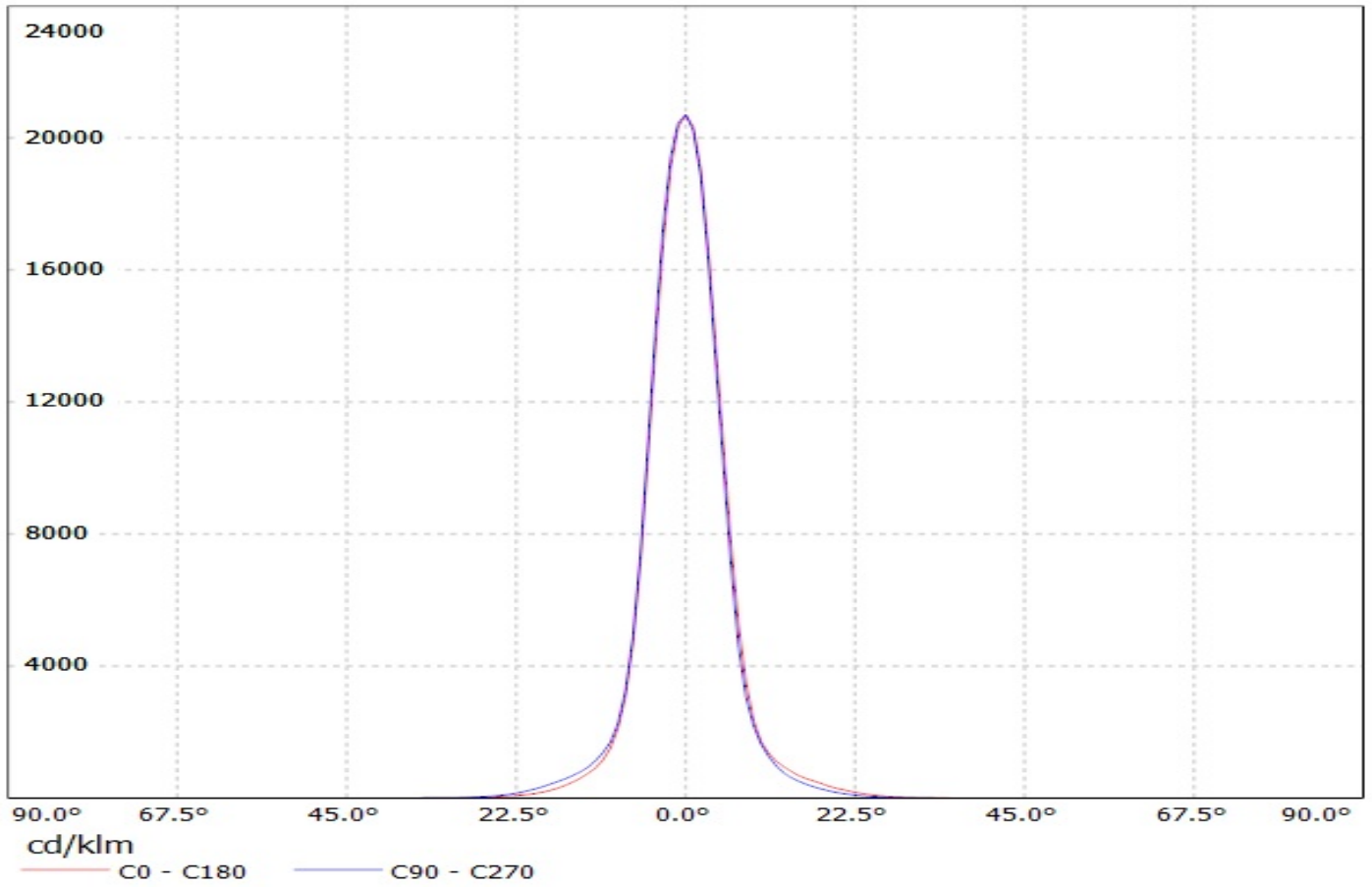

Luminaire: Ledil Oy CA11663_HEIDI-RS (Nichia 219B 109lm @ 250mA) Efficiency=92%
Lamps: 1 x Nichia 219B 109lm @ 250mA

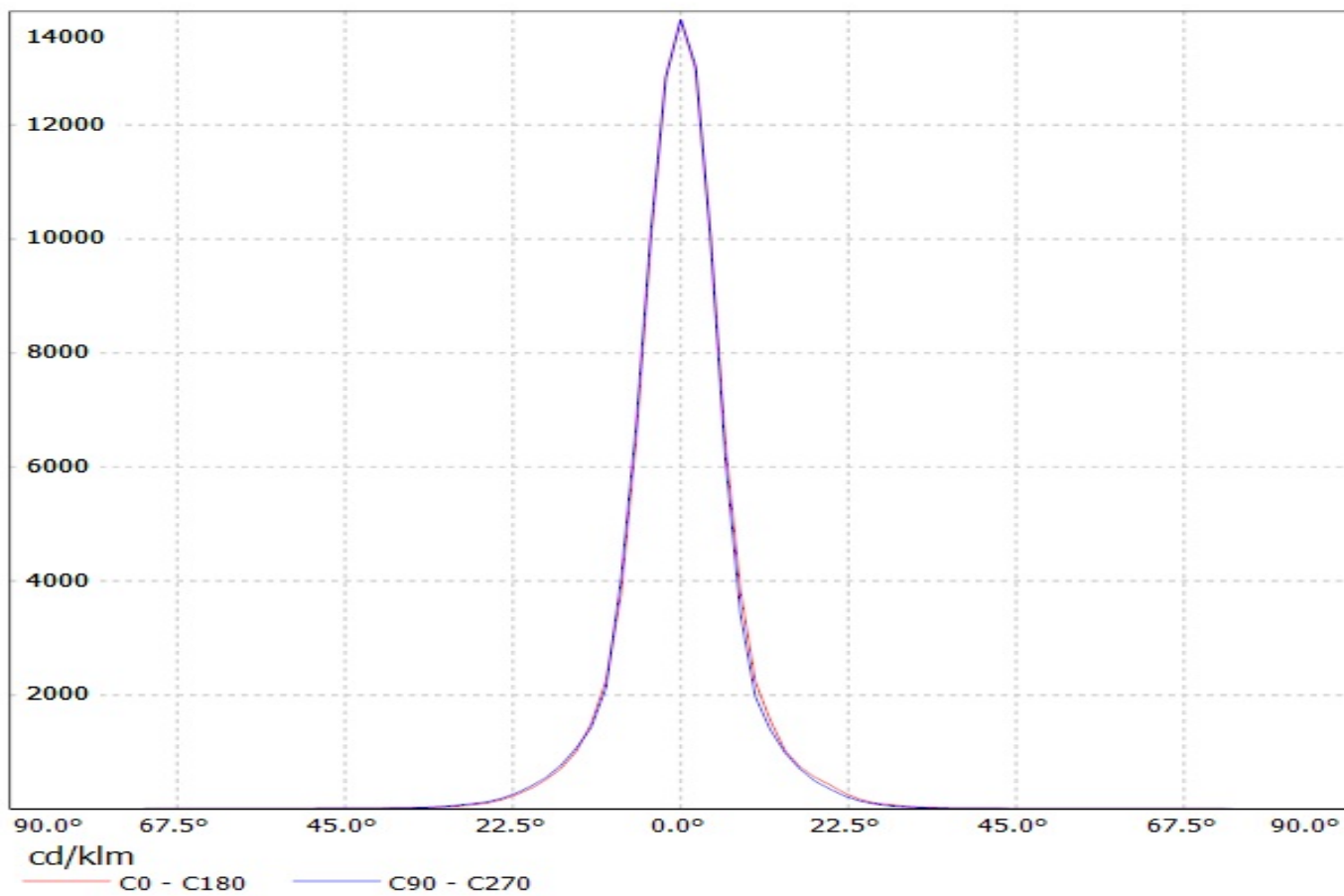

Ledil Oy CA11663_Heidi-RS-OS CA11663_Heidi-RS-OS / LDC (Polar)

Luminaire: Ledil Oy CA11663_Heidi-RS-OS CA11663_Heidi-RS-OS
Lamps: 1 x Osram Oslon 80 deg white

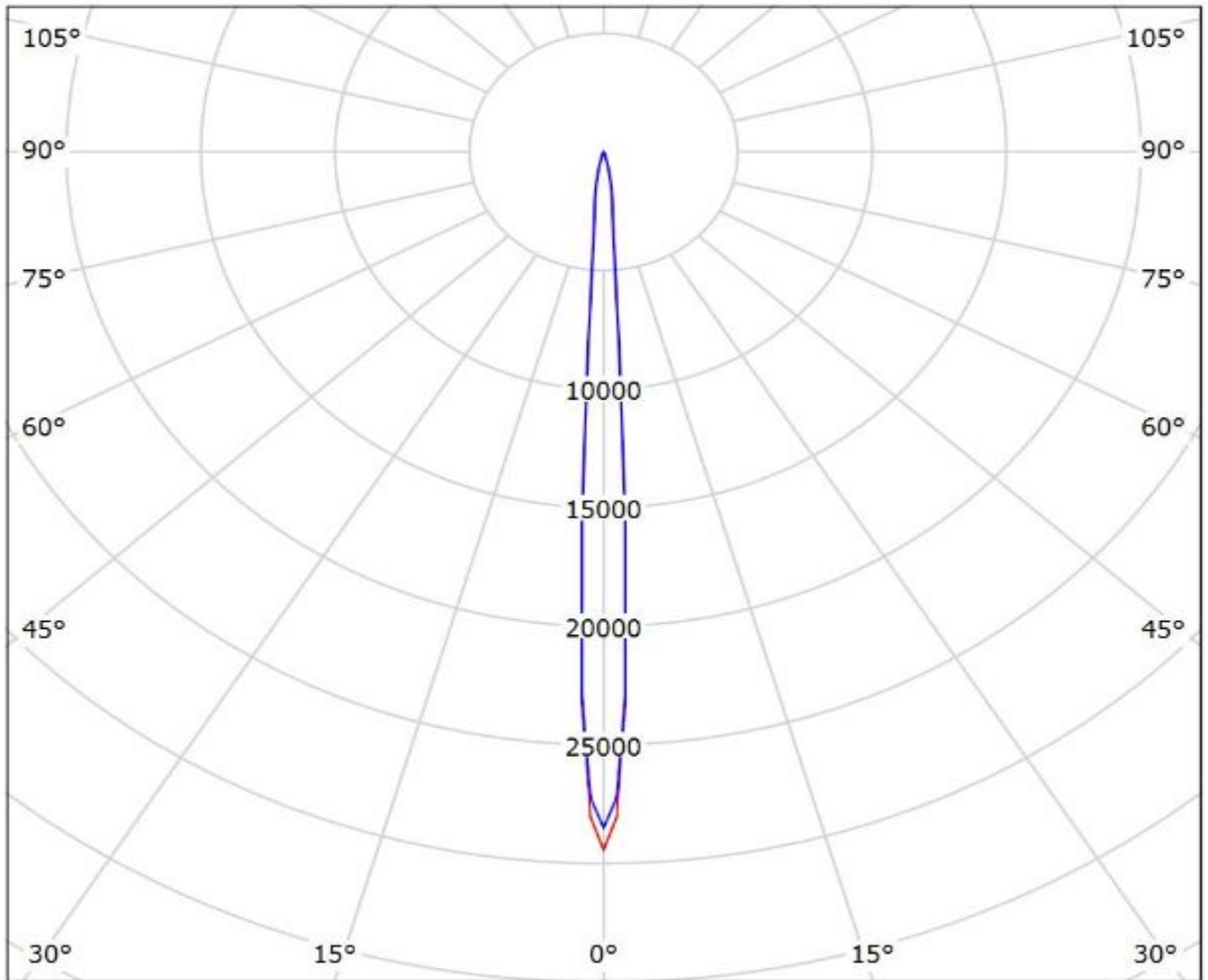

cd/klm

— C0 - C180

— C90 - C270

Ledil Oy C11624_GT3-OSL150-WW C11624_GT3-OSL150-WW / LDC (Polar)

Luminaire: Ledil Oy C11624_GT3-OSL150-WW C11624_GT3-OSL150-WW

Lamps: 1 x Osram OSL 150 deg white

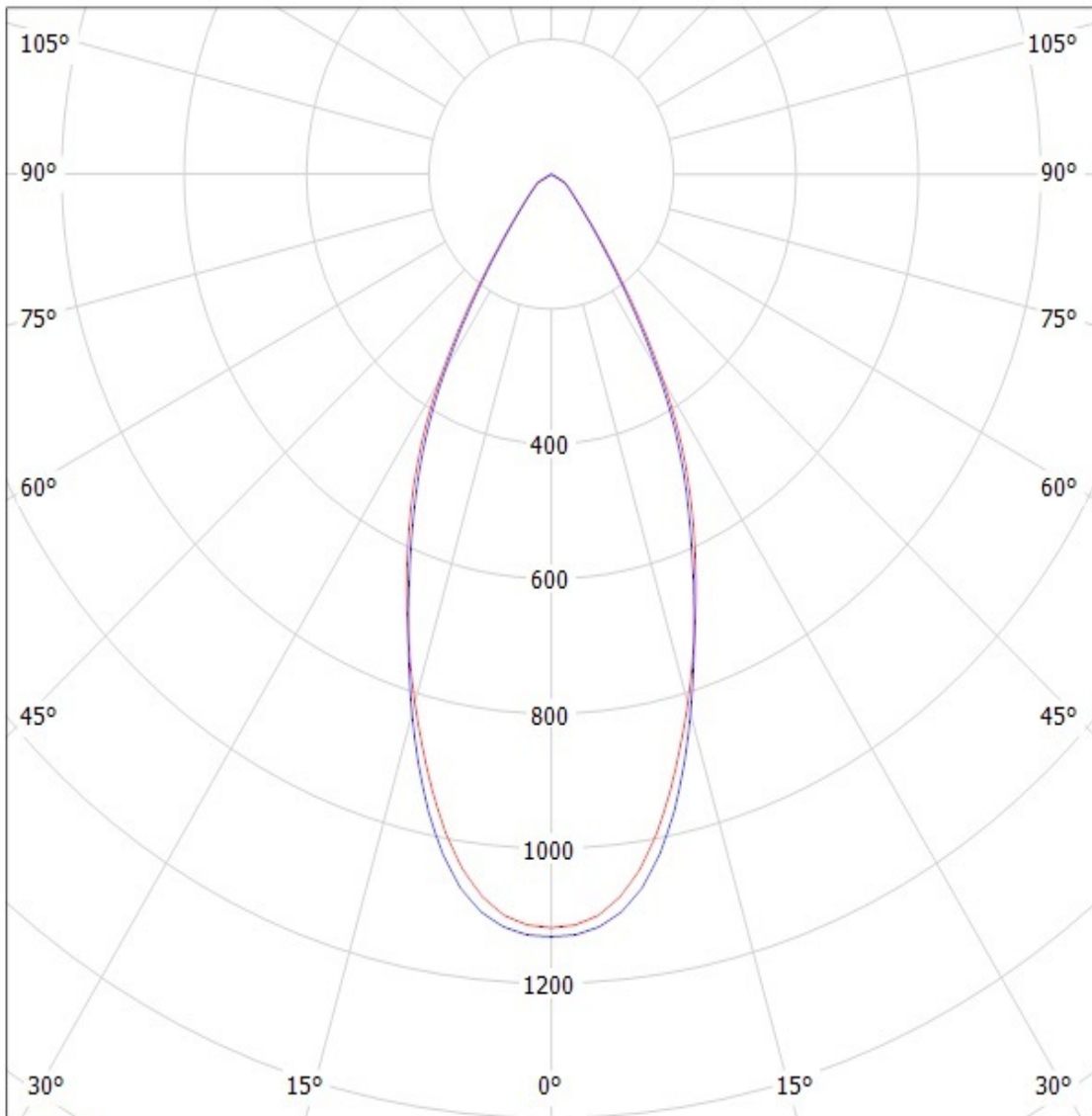

cd/klm

— C0 - C180

— C90 - C270

SIMULATED

Luminaire: LEDiL Oy CA11663_HEIDI-RS_(Luxeon_C_WHITE)

Lamps: 1 x Luxeon_C_WHITE_84.6969lm@250mA_P=0.7410W_I=0.250A

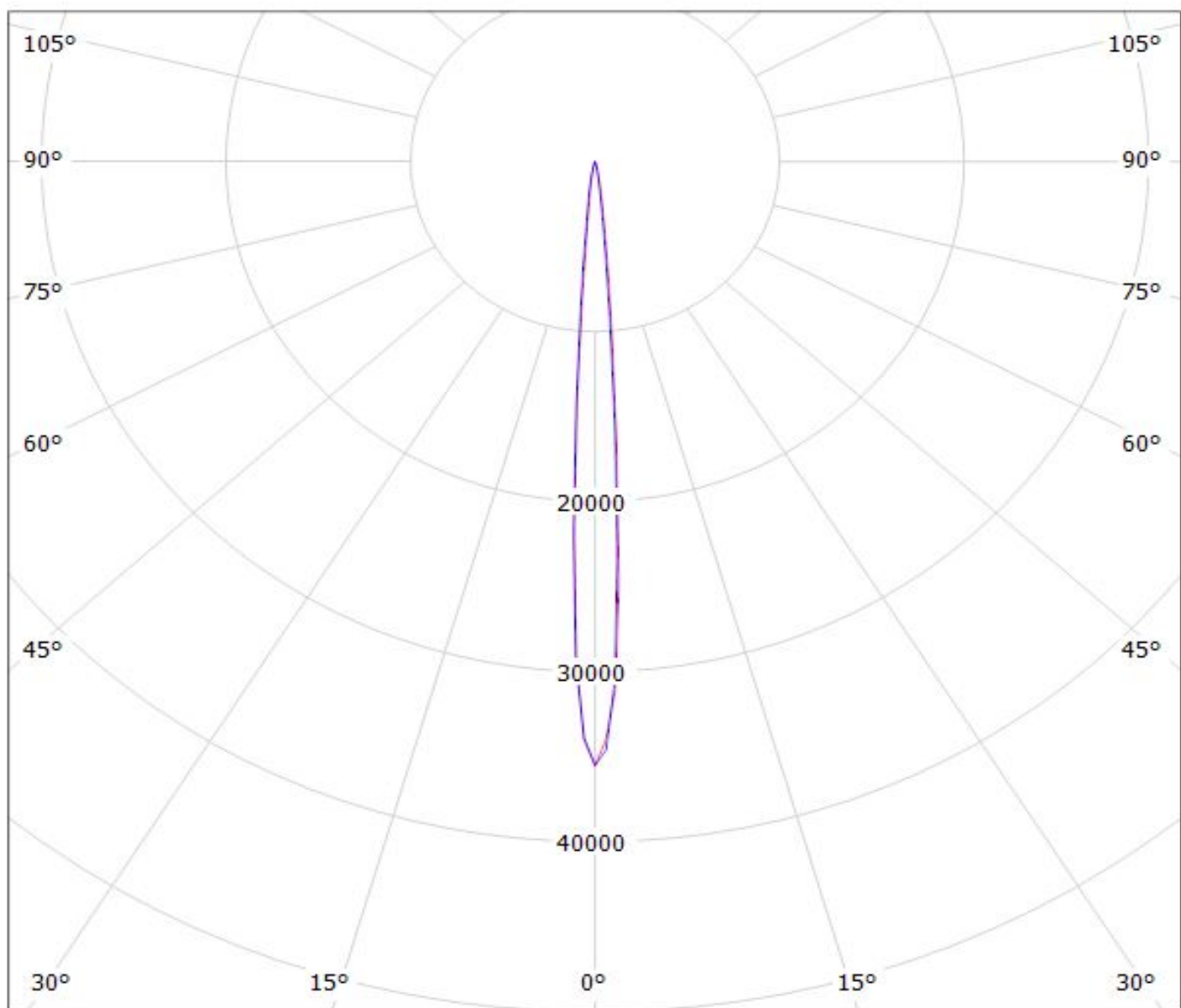

cd/klm

— C0 - C180

— C90 - C270

$\eta = 92\%$

Ledil Oy C11624_GT3-XP-WW C11624_GT3-XP-WW / LDC (Polar)

Luminaire: Ledil Oy C11624_GT3-XP-WW C11624_GT3-XP-WW

Lamps: 1 x Cree XP-E x3 white

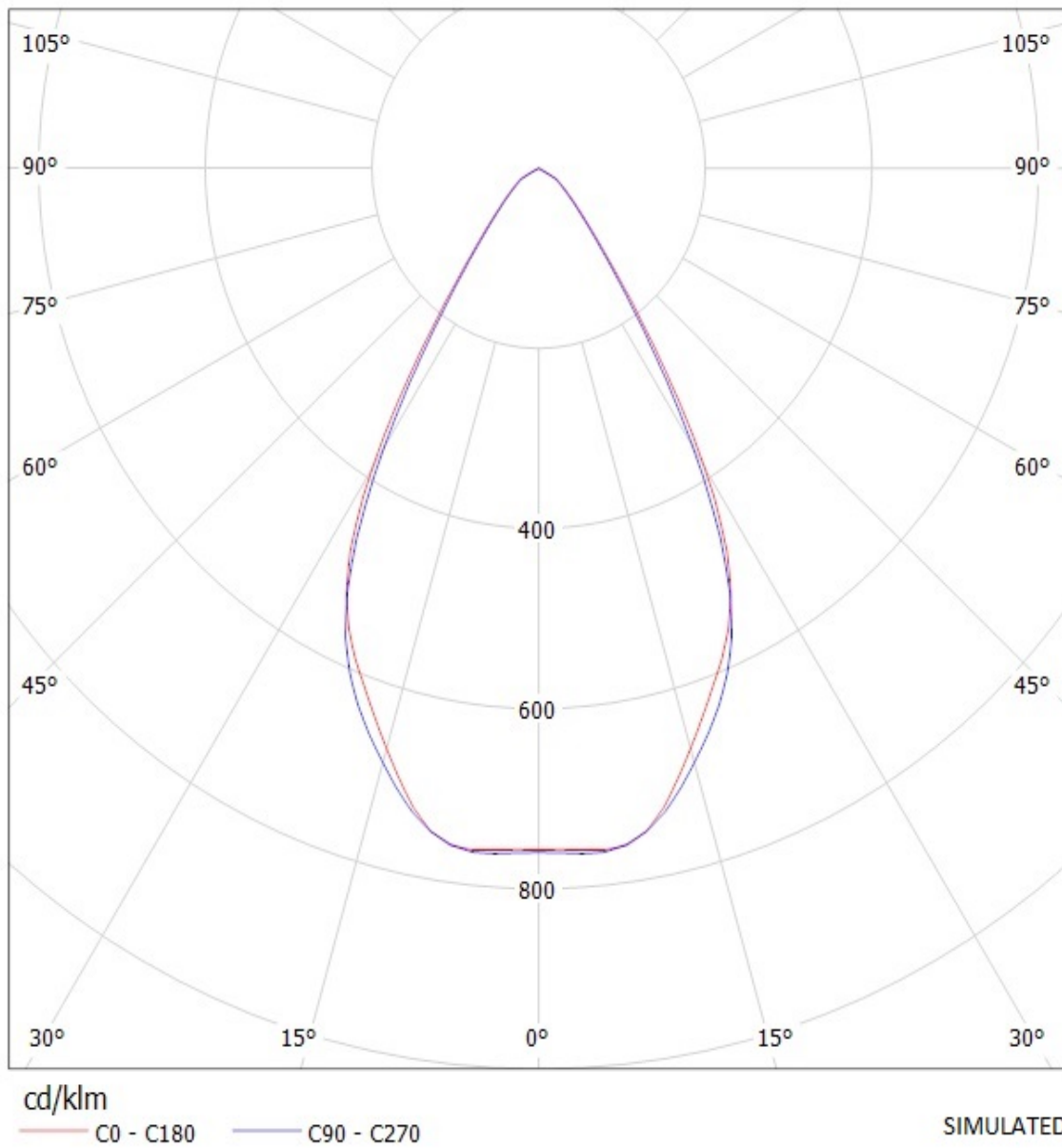

Luminaire: LEDiL Oy CA11663_HEIDI-RS_(XP-E2) Eff. 90%
Lamps: 1 x Cree XP-E2 92lm@250mA CCT:5500K P:0.8W

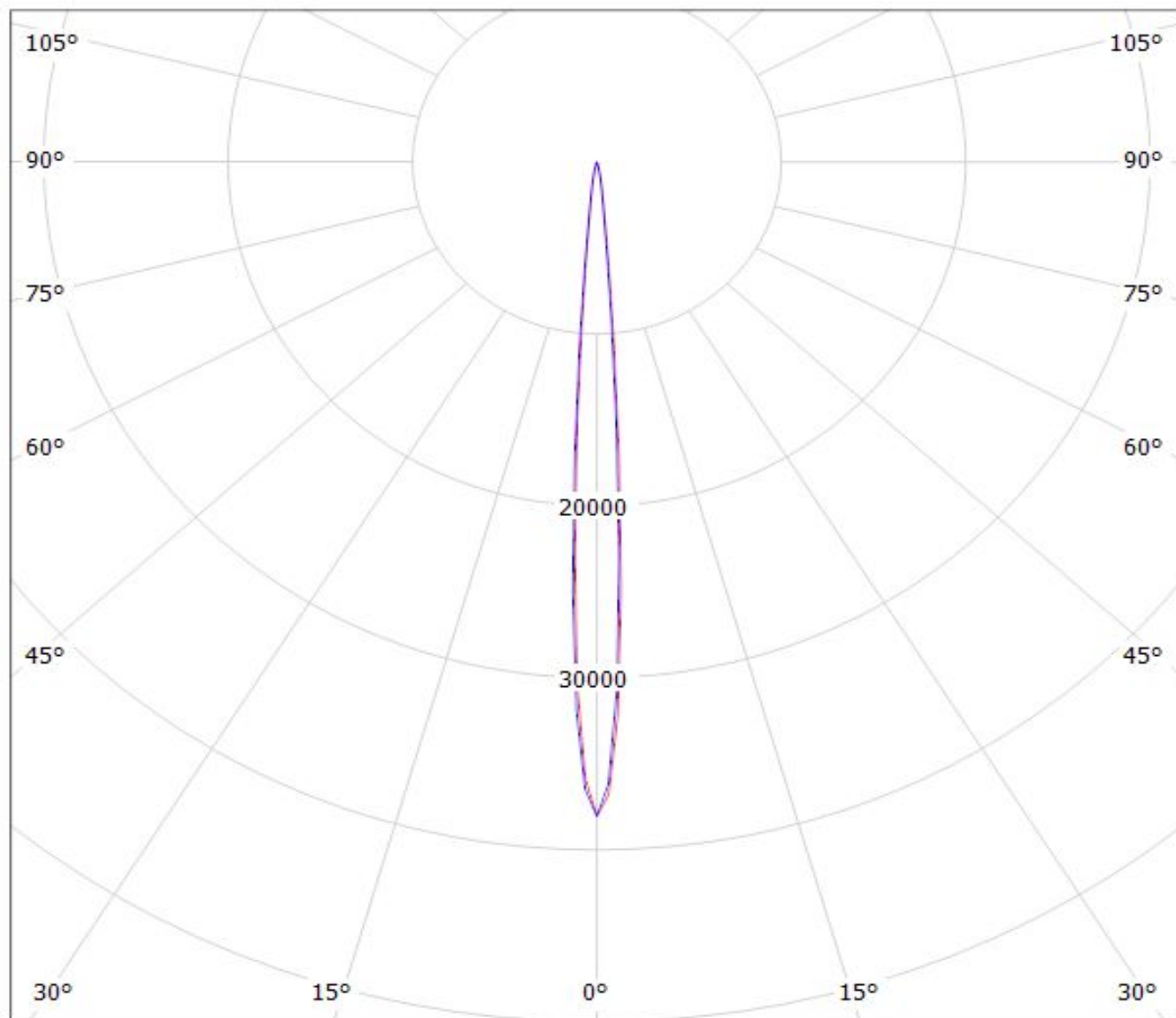

cd/klm

$\eta = 90\%$

— C0 - C180

— C90 - C270

Ledil Oy C11624_GT3-XP-G-WW C11624_GT3-XP-G-WW / LDC (Polar)

Luminaire: Ledil Oy C11624_GT3-XP-G-WW C11624_GT3-XP-G-WW

Lamps: 1 x Cree XP-G x3 white

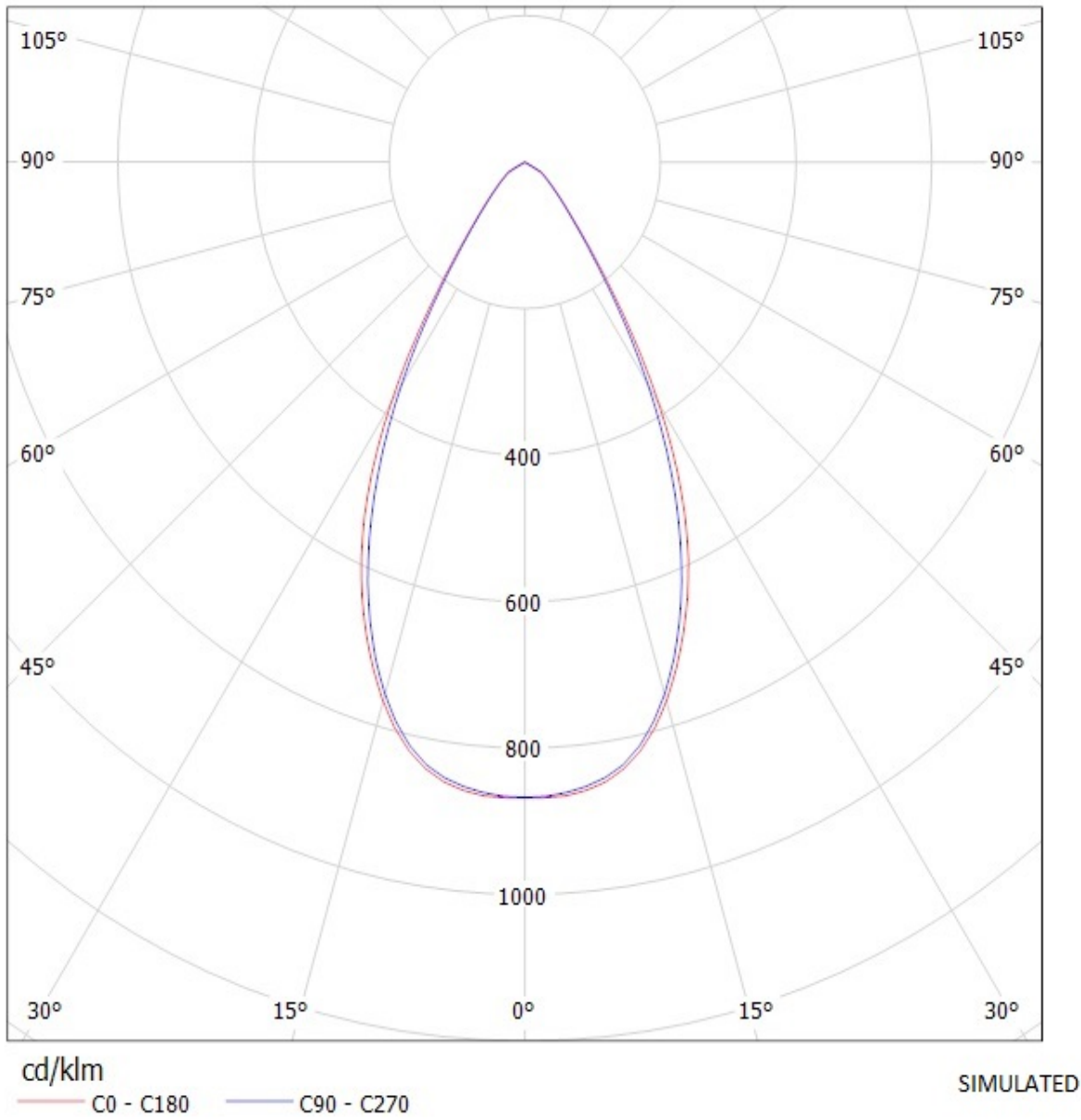

Luminaire: Ledil Oy CA11663_HEIDI-RS_(NCSxx19B) Efficiency=90%

Lamps: 1 x Nichia NCSxx19B (NCSL119BE) 88lm @ 250mA CCT=3000K P=0.8W I=250mA

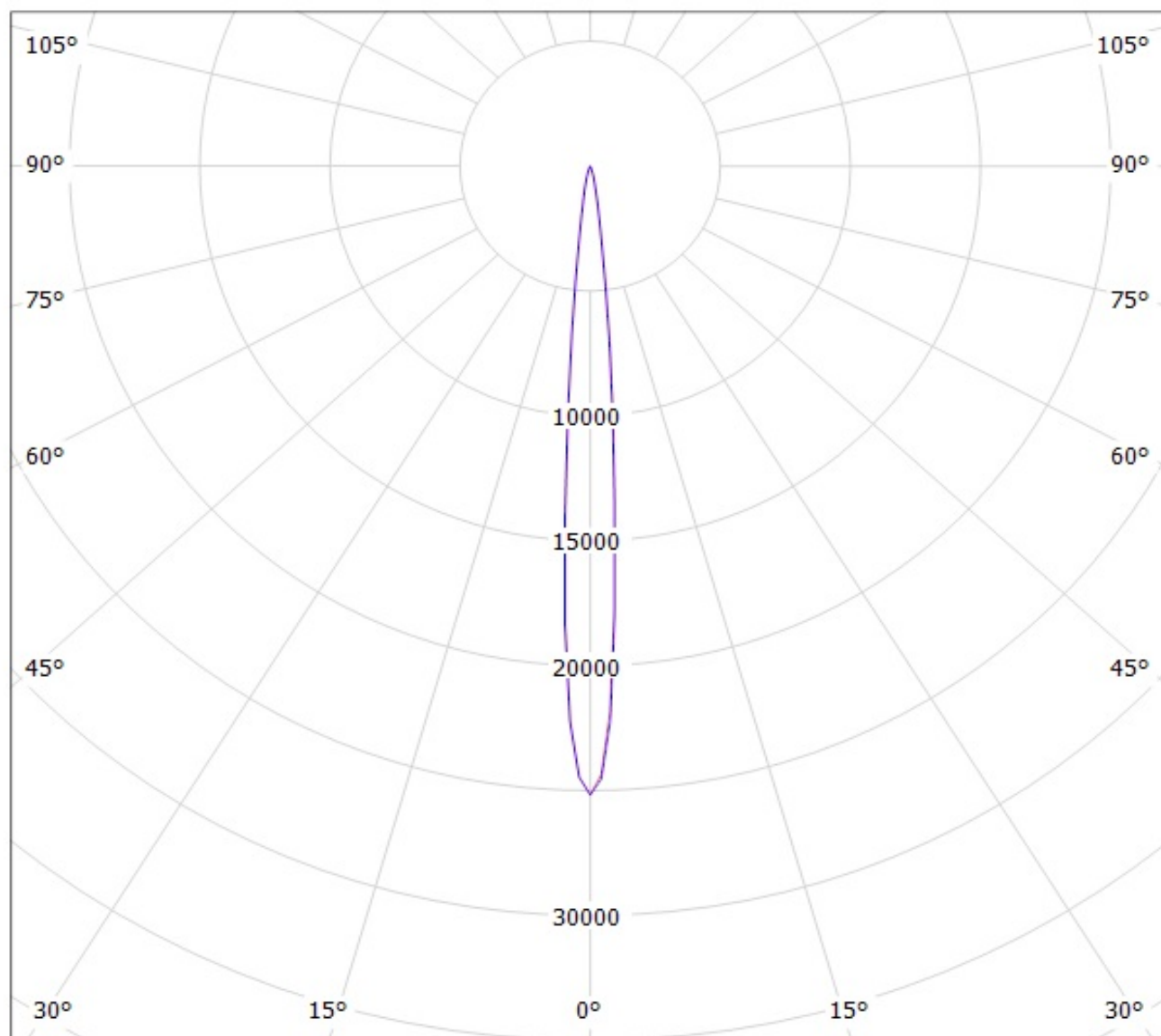

cd/klm

— C0 - C180

— C90 - C270

Luminaire: Ledil Oy CA11663_HEIDI-RS_(Luxeon_TX)

Lamps: 1 x Luxeon TX (L1T2-3585) 108lm @ 250mA CCT=3521K P=0.73W I=250mA

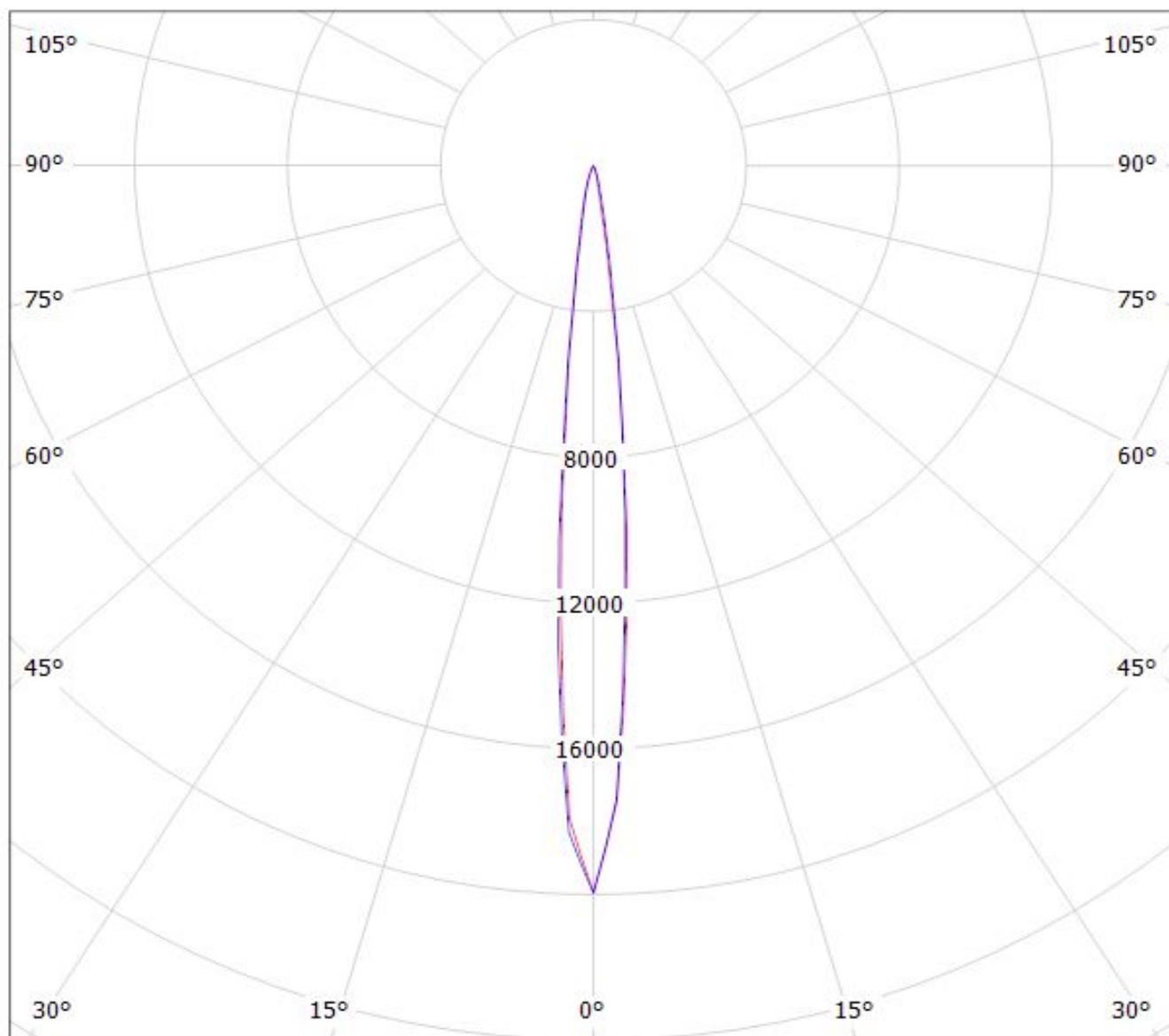

cd/klm

— C0 - C180

— C90 - C270

$\eta = 90\%$

Ledil CA11663_HEIDI-RS_(Fortimo_FastFlex_LED_board 2x8/757_DS_G3) / LDC (Polar)

Luminaire: Ledil CA11663_HEIDI-RS_(Fortimo_FastFlex_LED_board 2x8/757_DS_G3)
Lamps: 1 x Philips_Fortimo_FastFlex_LED_board 2x8/757_DS_G3_(XP-G2)
_3428.78lm@500mA_P=23.7W_I=0.5A

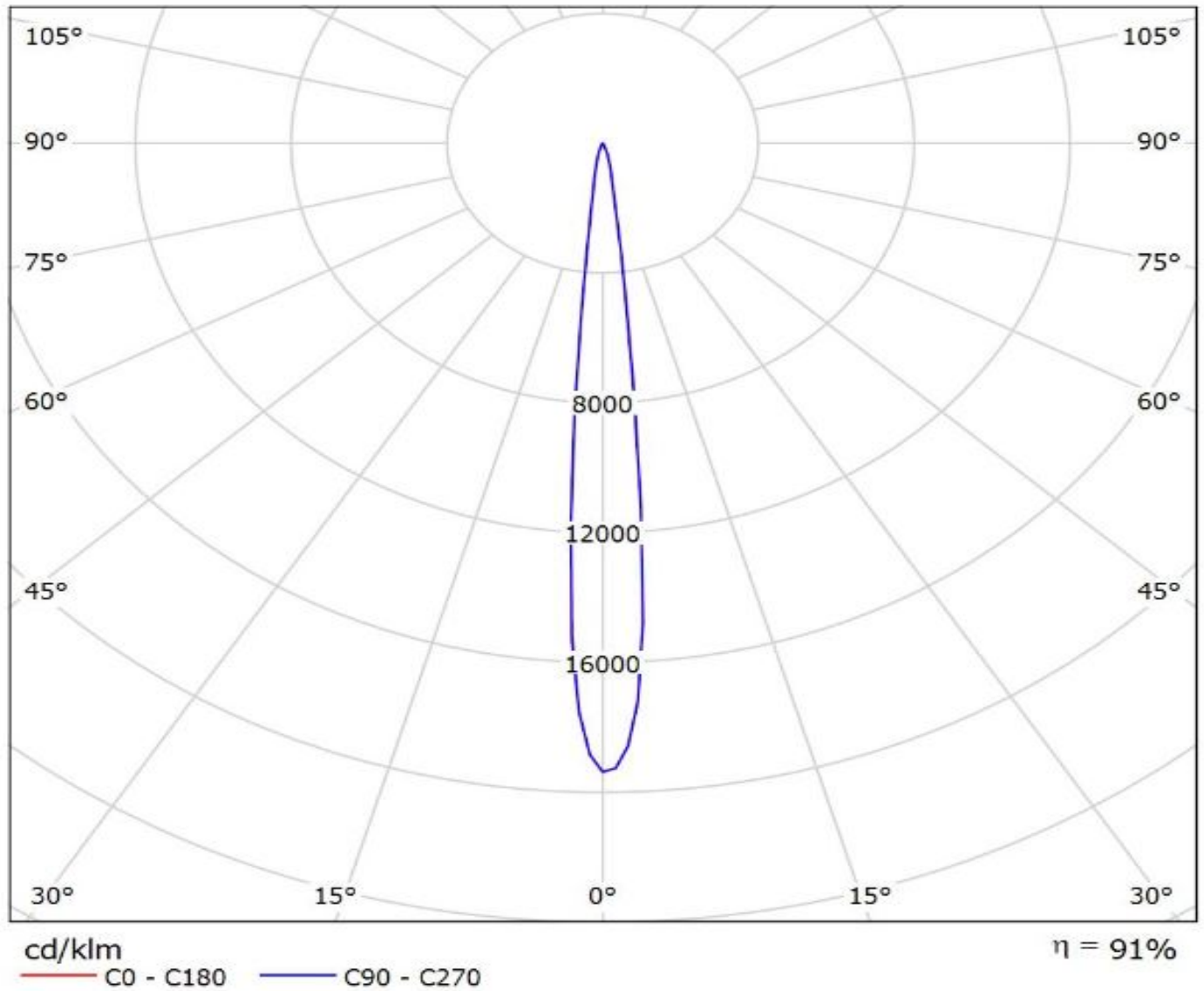

LEDiL Oy CA11663_HEIDI-RS_(LUXEON_T)_1 Eff.91.7% / LDC (Polar)

Luminaire: LEDiL Oy CA11663_HEIDI-RS_(LUXEON_T)_1 Eff.91.7%
Lamps: 1 x LUXEON T (74lm@250mA)

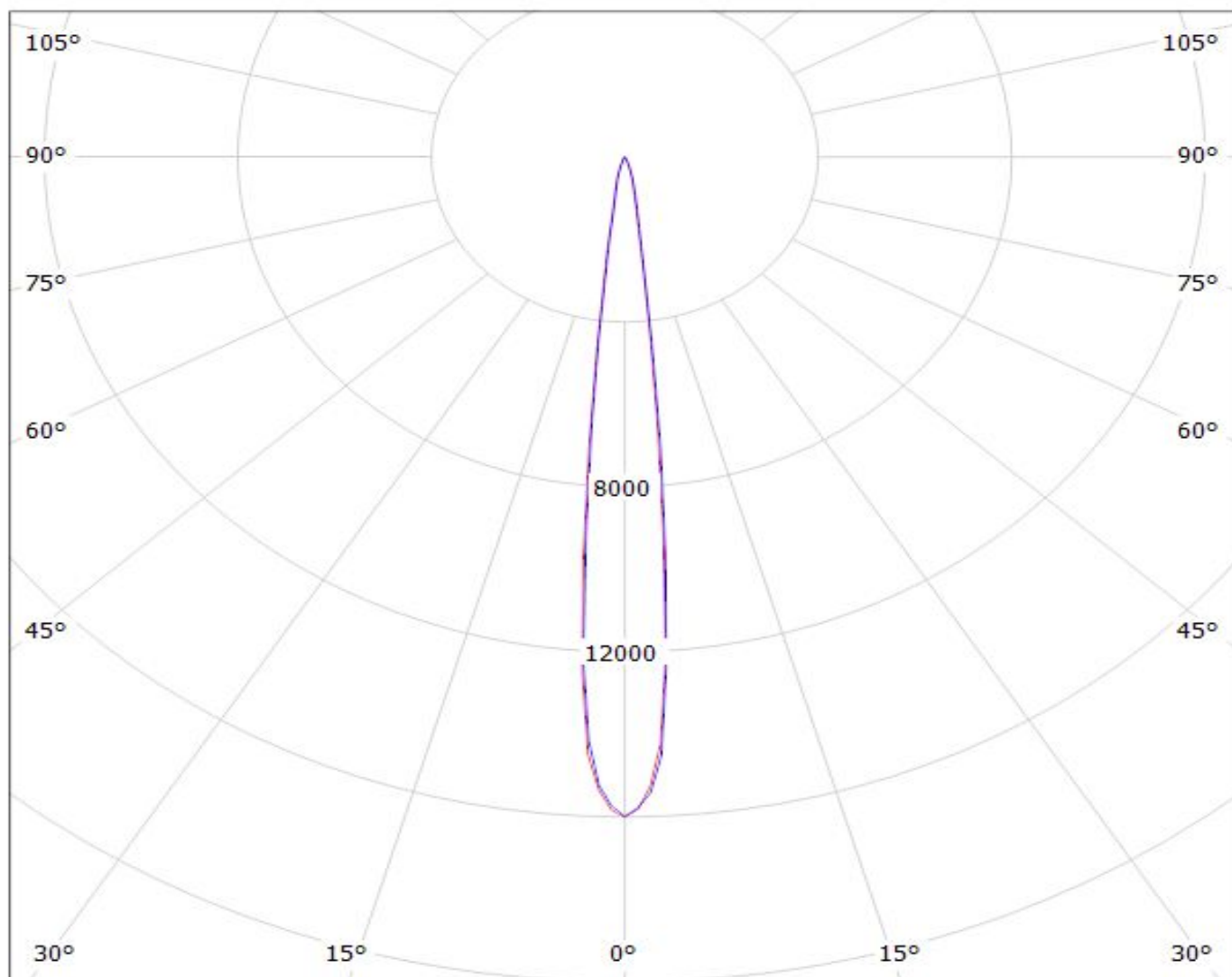

cd/klm

— C0 - C180

— C90 - C270

$\eta = 91\%$

Luminaire: LEDiL Oy CA11663_HEIDI-RS_(Z5M1)

Lamps: 1 x Seoul_Z5M1_107.648lm@250mA_CCT=9074K_P=0.739754W_I=249.9mA

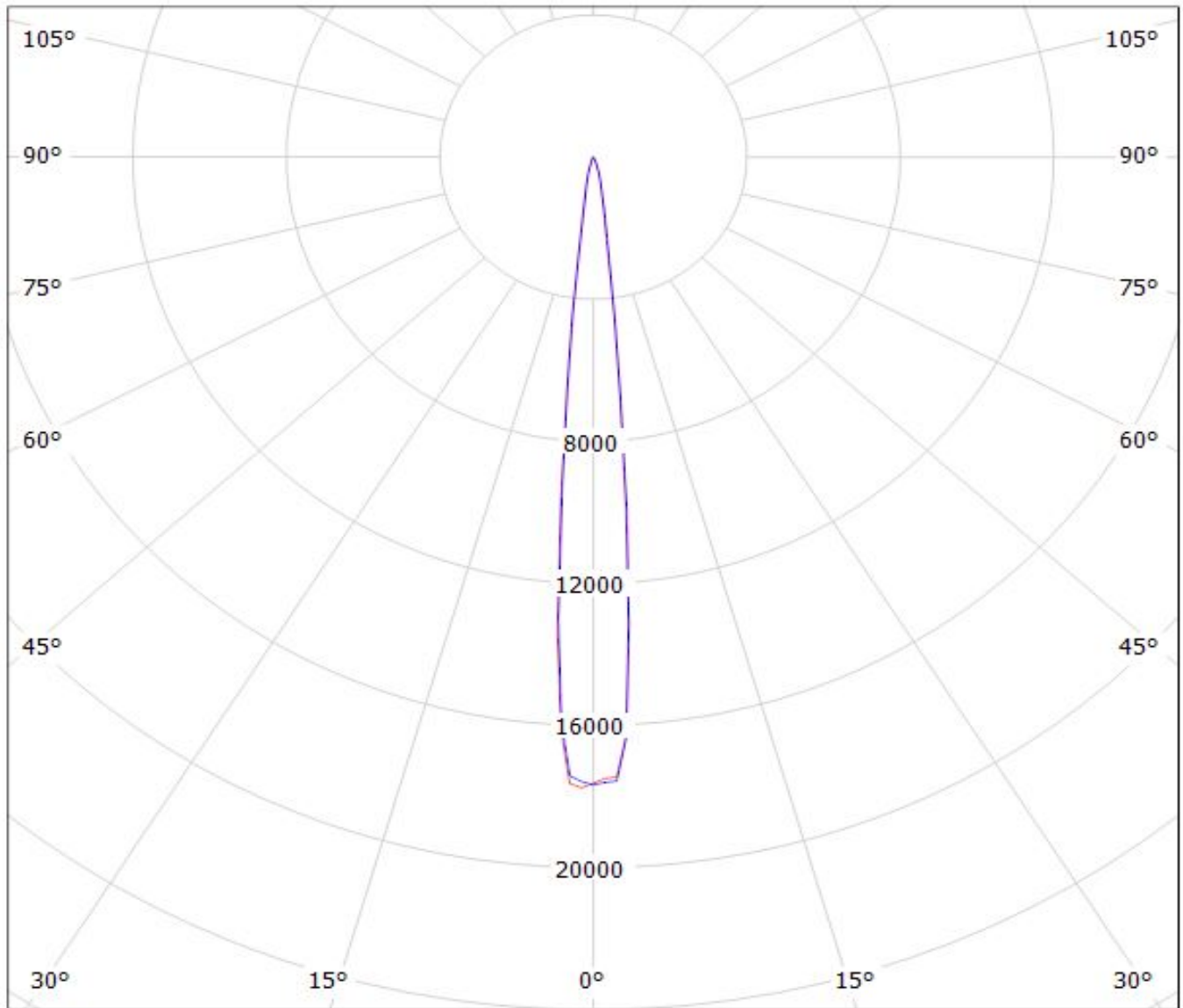

cd/klm

$\eta = 95\%$

— C0 - C180

— C90 - C270

Luminaire: LEDil Oy CA11663_HEIDI-RS_(XP-G2) Efficiency=91%
Lamps: 1 x Cree XP-G2 (XPGBWT-L1-0000-00FE4) 100.7lm @ 250mA CCT=4900K P=0.7W I=250mA

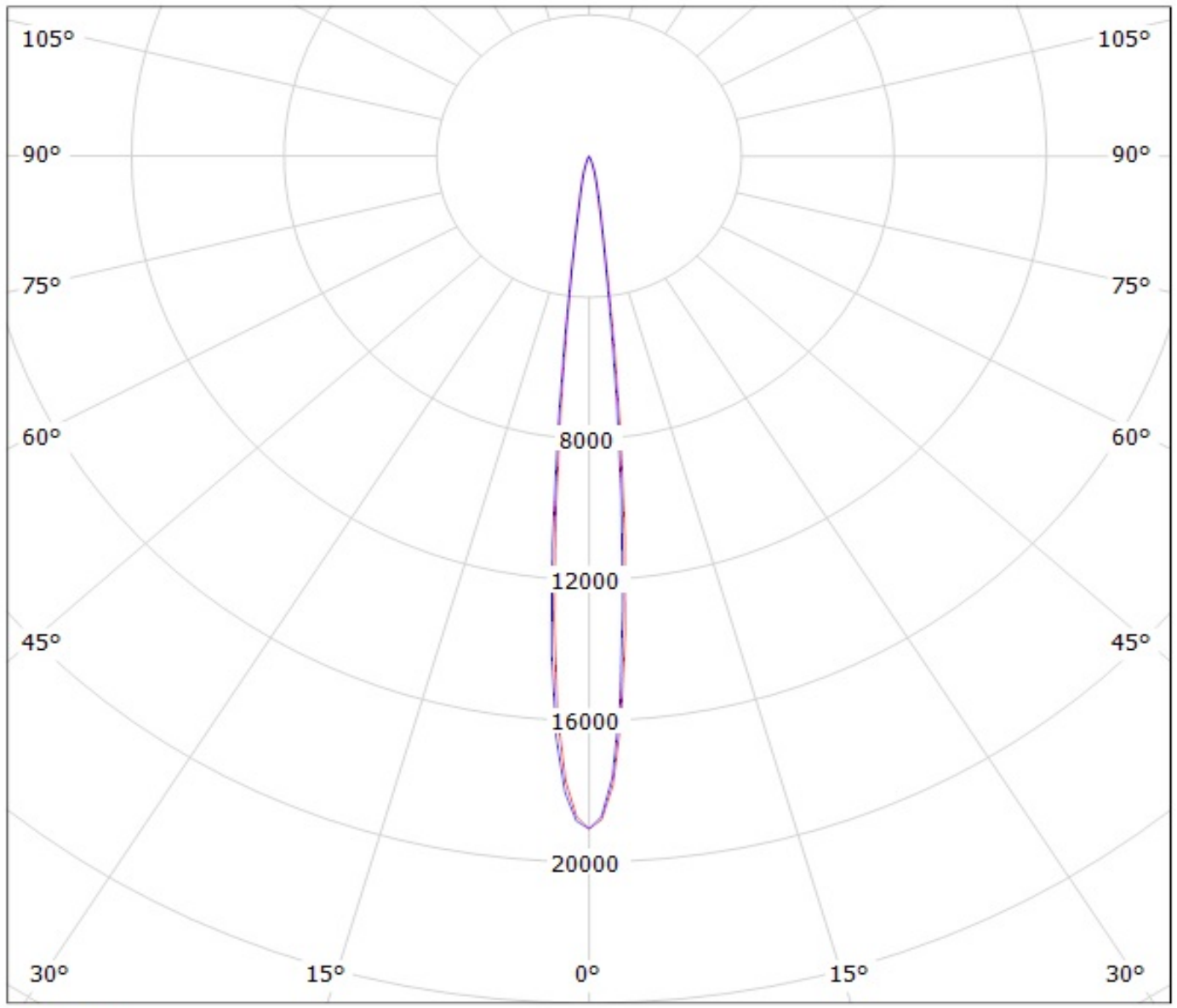

cd/klm
— C0 - C180 — C90 - C270

Luminaire: Ledil Oy CA11663_HEIDI-RS_(LH351Z) Efficiency=89%
Lamps: 1 x Samsung LH351Z (90.14lm @ 250mA) CCT=6500K P=0.7W I=250mA

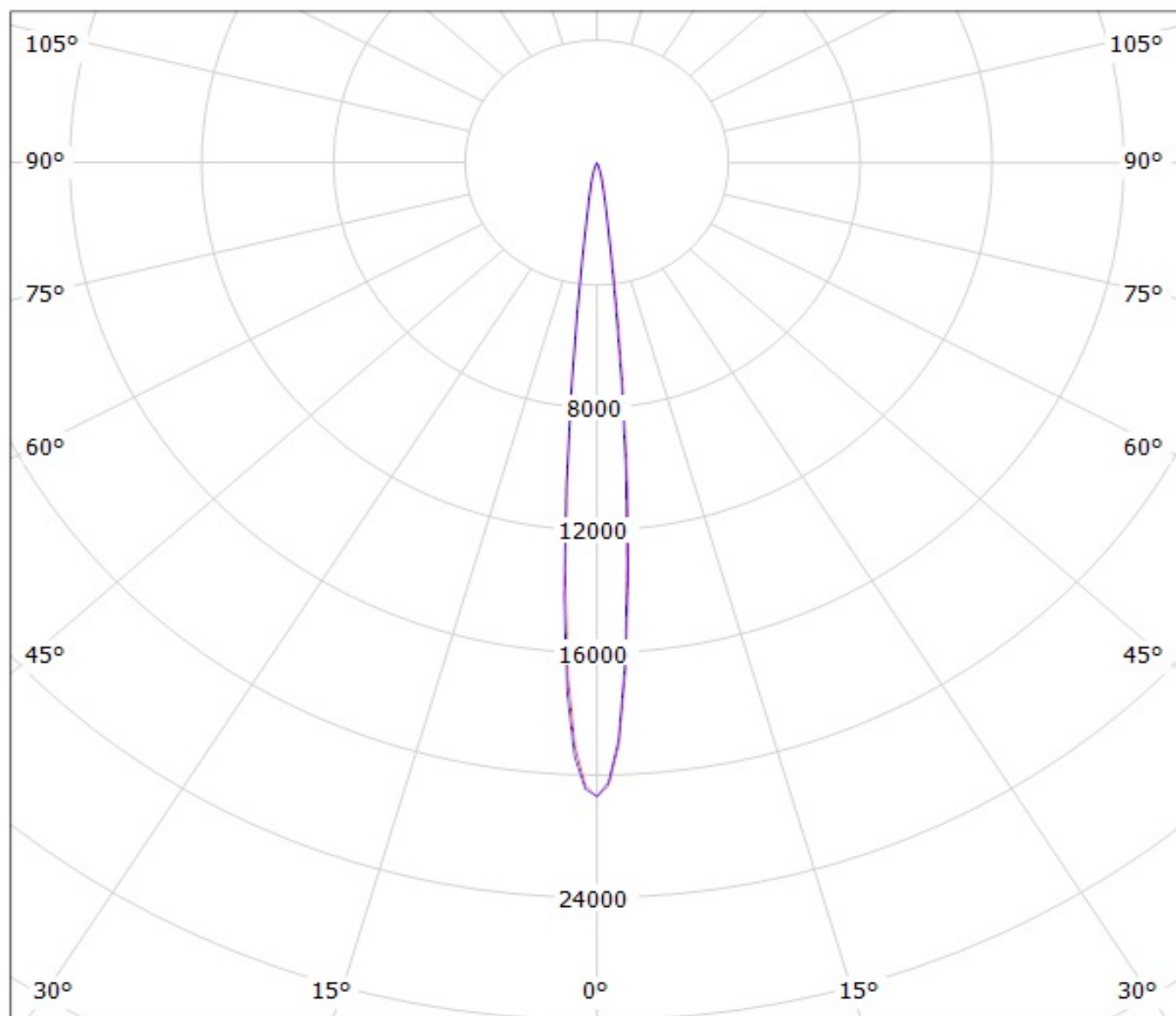

cd/klm

— C0 - C180 — C90 - C270

Luminaire: Ledil Oy CA11663_HEIDI-RS (Nichia 219B 109lm @ 250mA) Efficiency=92%
Lamps: 1 x Nichia 219B 109lm @ 250mA

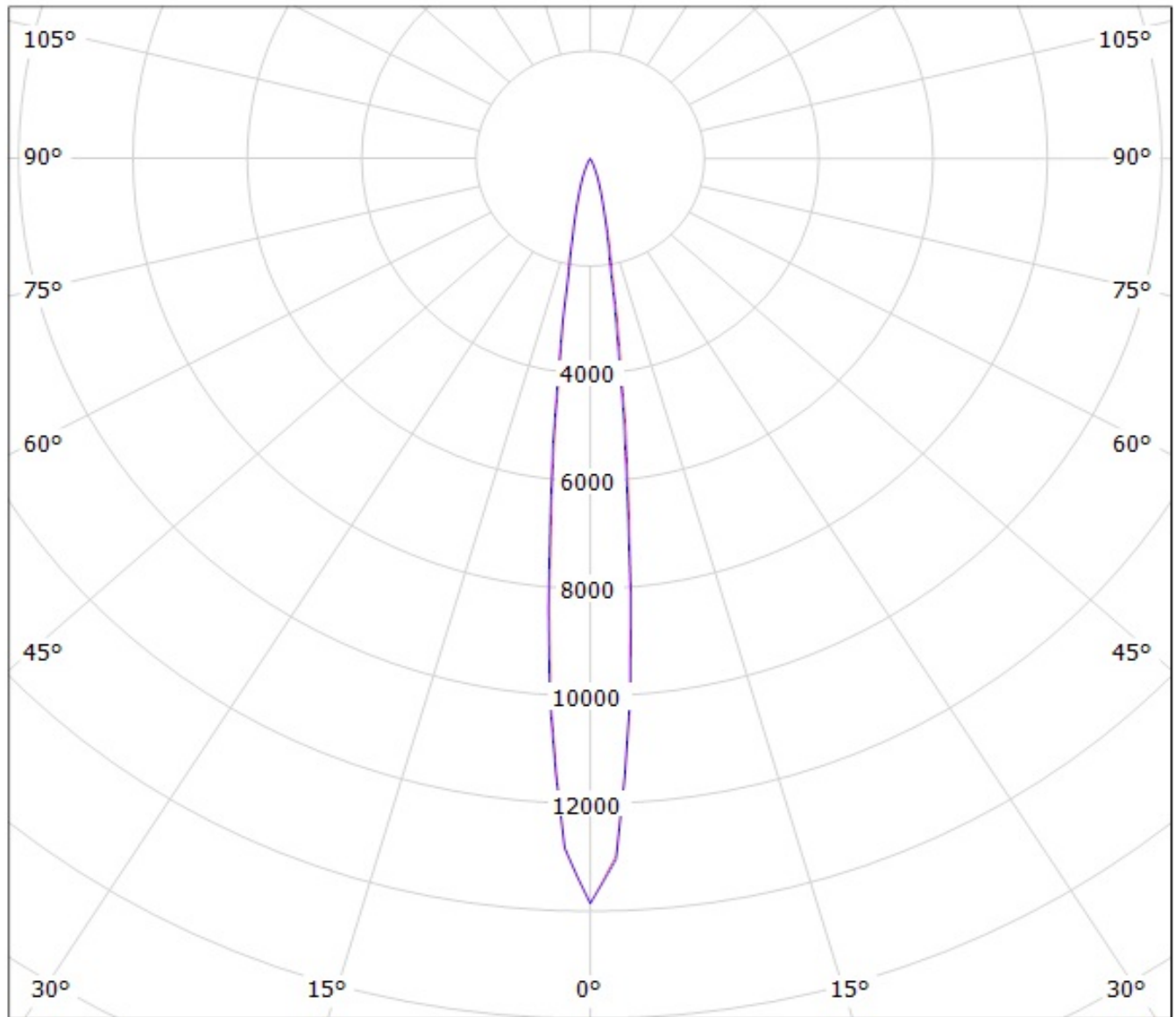

cd/klm

— C0 - C180

— C90 - C270

NOTE: The typical divergence will be changed by different color, chip size and chip position tolerance. The typical total divergence is the full angle measured where the luminous intensity is half of the peak value.