

9137 012 15302

Brand Name	XITANIUM
Description	Xitanium 150W .35/1.41/1.53A 1-10V sXt
Input Voltage	220~240
Input Frequency	50/60Hz
RoHS	Yes
Status	Active

Electrical Specifications

Output Power (W)	Output Voltage (V)	Output Current (A)	Efficiency @ Max Load	Operating Temp. Range (°C)	Input Current at 240V (A)	Max. Input Power (W)	Inrush Current (A _{pk} /50%- μ s)	Max. THD (%)	Power Factor @ Max Load	Surge Protection Common/Diff (KV)	Weight (Lbs/grams)	IP Rating
150	115~280	0.35/0.41/0.530	>92%	-40~55°C	0.69	165	130/140	20	>0.95	3/3	2.8/1270	IP66

Wire Diagram

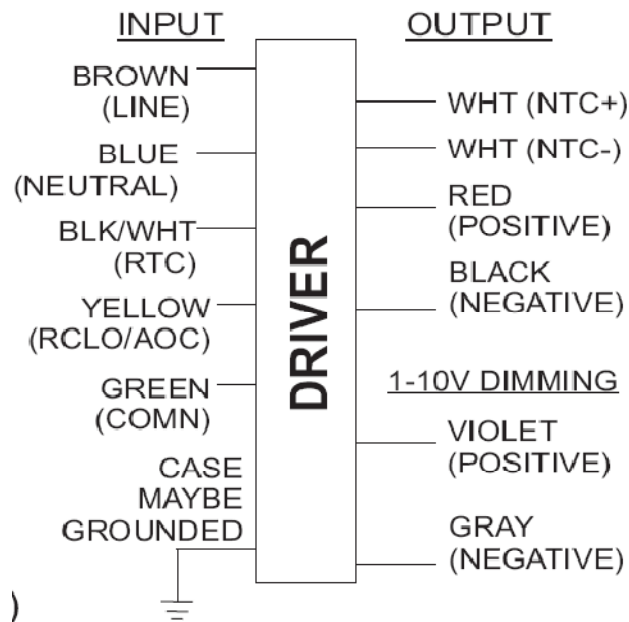

Input and output use lead-wires.
Lead-wires are 18AWG 105C/600V solid copper.

Standard Lead Length is 500mm+/-10mm on all wires outside the can

Dimming Method	Dimming Range (%)	Min. Output Power(W)	Dimming Source Current
1-10V Isolated	100% ~ 10%	42	150uA

Enclosure



	in. (mm)
Case Length	8.38 (211.1)
Case Width	2.35 (59.1)
Case Height	1.47 (37.1)
Mounting Length	9.0 (226.2)
Mounting Width	1.7 (42.9)
Overall Length	9.54 (240.5)



Revised 08/12/2010

PHILIPS LIGHTING N.A.

10275 WEST HIGGINS ROAD · ROSEMONT, IL 60018
Tel: 800-322-2086 · Fax: 888-423-1882 · www.philips.com/advance
Customer Support/Technical Service: 800-372-3331 · OEM Support: 866-915-5886



9137 012 15302

Brand Name	XITANIUM
Description	Xitanium 150W .35/.41/.53A 1-10V sXt
Input Voltage	220~240
Input Frequency	50/60Hz
RoHS	Yes
Status	Active

Electrical Specifications

Product Data

Order code	Add M to the end of the below numbers
Full product code	913701215302 150W 1-10V Dim
Full product name	LED Xitanium EU 220-240V 150W .35/.41/.53A 280V 1-10V Dim
Net weight per piece	1.27 KG / 2.8 lbs
Interface	1-10V Dimming
Ambient Temp Range	-40C to +55C
Corresponding TC	-15C to +80C
Line Voltage	220-240V
Line Current	0.69A
Line Frequency	50/60Hz
IP Classification	66
Life @ Tcase 67C	80000 hr [nom] refer to graph below
Life @ Tcase 75C	50000 hr [nom] refer to graph below
Suitable for Outdoor use?	Yes
Max TC	80C
Inrush current Width	130 A @ 230V Line @ 140uS Width @50% height, see graph
Maximum ballast number on MCB 16A	10 [max]
LED Current Tolerance	-5%/+5%
Earth leakage current	0.7 mA [max]
Mains voltage safety (AC)	-27%/+10%
Mains voltage performance (AC)	-10%/+10%
Min. Mains voltage operational	180 V [min]
Output peak voltage	300 V [max]
Output Current ripple	30% @530 mA (ripple = pk-pk/avg)
THD total	< 20%
THD 3rd Harmonic	< 15%
PF @ Max Load	>0.95
Wire Isolation	All wires are Double isolated
Protections	Short Circuit Protection and Open Circuit Protection

Installation & Application Notes:

Section I – Physical Characteristics

- 1.1 LED Driver shall be installed inside an electrical enclosure**
- 1.2 Wiring inside electrical enclosure shall comply with 600V/105°C rating or higher.**

Section II – Performance

- 2.1 LED Driver has a rated lifetime of 80,000 hours @ TC ≤67C.**
- 2.2 LED Driver tolerates sustained open circuit and short circuit output conditions without damage.**
- 2.3 LED Driver maximum allowable case temperature is 80°C – see product label for measurement location.**
- 2.4 LED Driver reduces output power to LEDs if its case temperature exceeds >90°C –thermal protection.**
- 2.5 LED Driver complies with the requirements of CE, ENEC and CISPR 15 Ed 7.2.**

Revised 08/12/2010

PHILIPS LIGHTING N.A.

10275 WEST HIGGINS ROAD · ROSEMONT, IL 60018
 Tel: 800-322-2086 · Fax: 888-423-1882 · www.philips.com/advance
 Customer Support/Technical Service: 800-372-3331 · OEM Support: 866-915-5886



9137 012 15302

Brand Name	XITANIUM
Description	Xitanium 150W .35/1.4/1.53A I-10V sXt
Input Voltage	220~240
Input Frequency	50/60Hz
RoHS	Yes
Status	Active

Electrical Specifications

Step AOC (Adjustable Output Current) Settings:

RCLO/AOC (between Yellow and Green Wires)	Short (or <30k)	100 - 200 kOhms	Open (or > 500 kOhms)
Nominal Current (I_{out})	350 mA	410 mA	530 mA

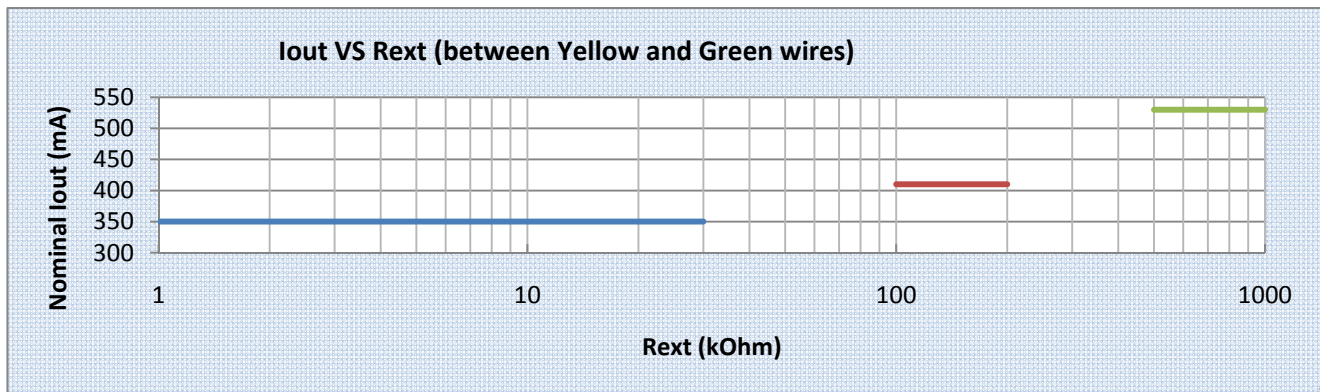

Temperature Profile Settings:

RTC (between BLK/WHT and Green Wires)	Short (or <30k)	100 - 200 kOhms	Open (or > 500 kOhms)
TC Profile	T_NTC-LED 3	T_NTC-LED 2	T_NTC-LED 1
T-range	70-75 C	65-70 C	60-65 C

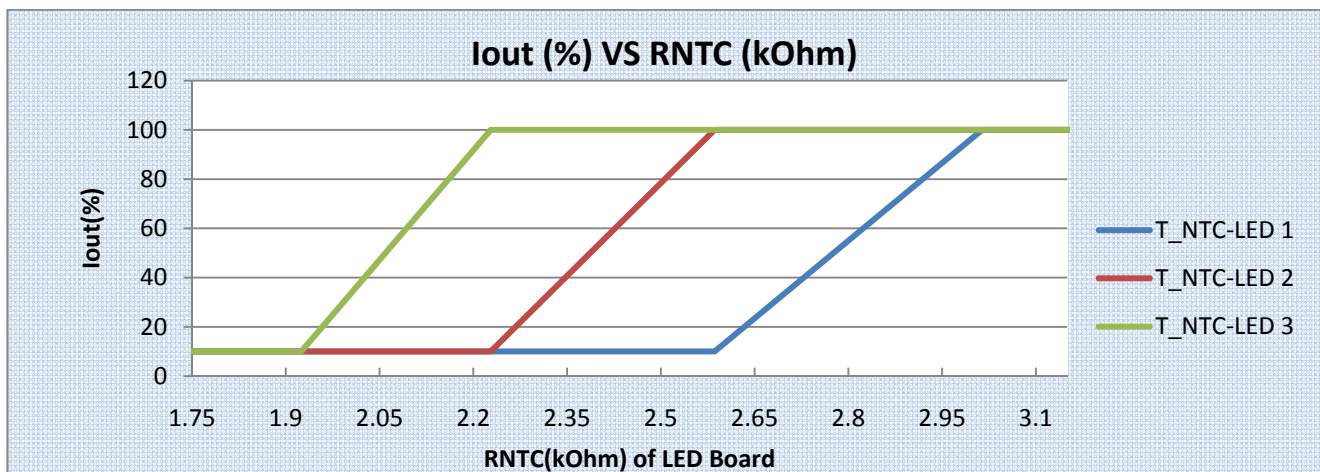

Revised 08/12/2010

PHILIPS LIGHTING N.A.

10275 WEST HIGGINS ROAD · ROSEMONT, IL 60018
 Tel: 800-322-2086 · Fax: 888-423-1882 · www.philips.com/advance
 Customer Support/Technical Service: 800-372-3331 · OEM Support: 866-915-5886



9137 012 15302

Brand Name	XITANIUM
Description	Xitanium 150W .35/1.4/1.53A I-10V sXt
Input Voltage	220~240
Input Frequency	50/60Hz
RoHS	Yes
Status	Active

Electrical Specifications

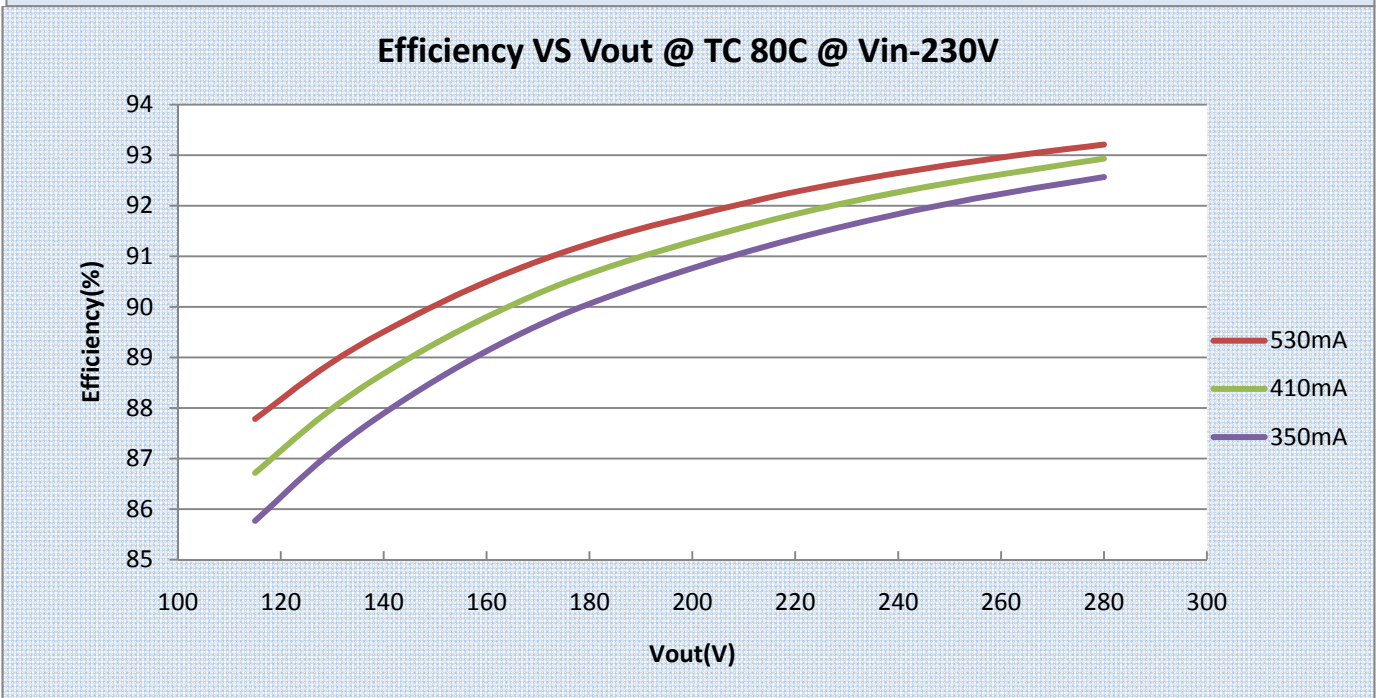
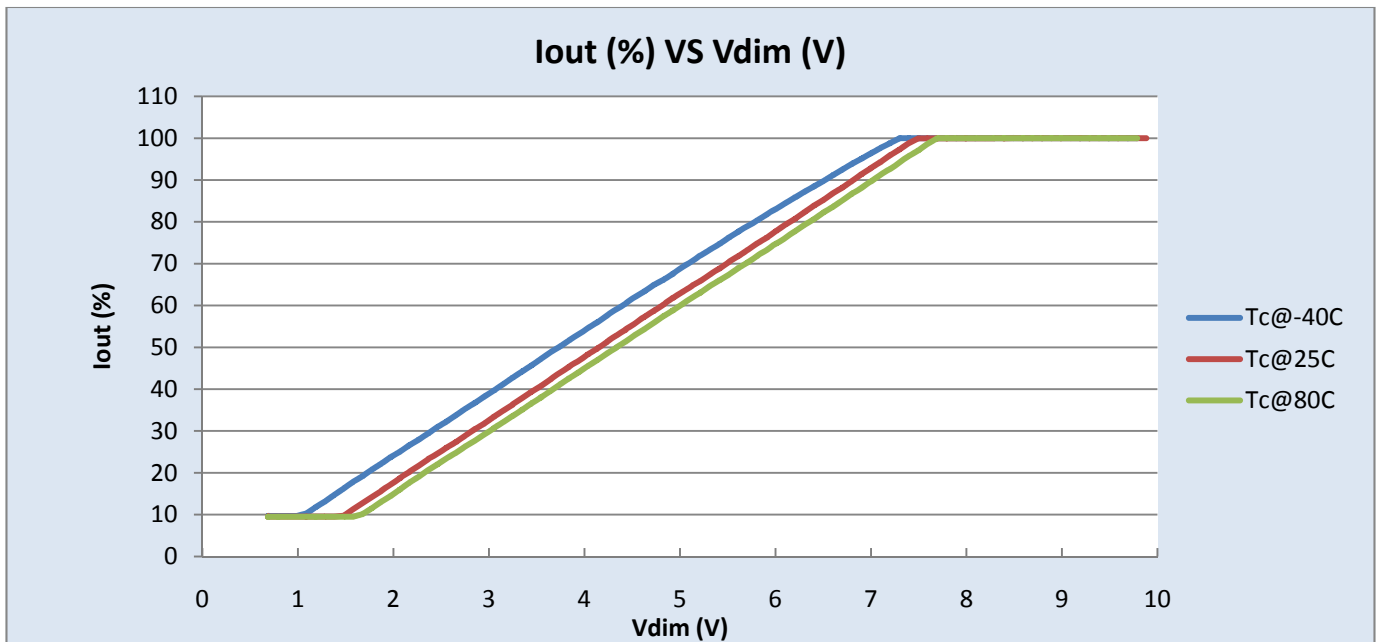

Revised 08/12/2010

PHILIPS LIGHTING N.A.

10275 WEST HIGGINS ROAD · ROSEMONT, IL 60018
Tel: 800-322-2086 · Fax: 888-423-1882 · www.philips.com/advance
Customer Support/Technical Service: 800-372-3331 · OEM Support: 866-915-5886



9137 012 15302

Brand Name	XITANIUM
Description	Xitanium 150W .35/1.41/1.53A I-10V sXt
Input Voltage	220~240
Input Frequency	50/60Hz
RoHS	Yes
Status	Active

Electrical Specifications

pf VS Pout @ TC 80C @Vin-230V

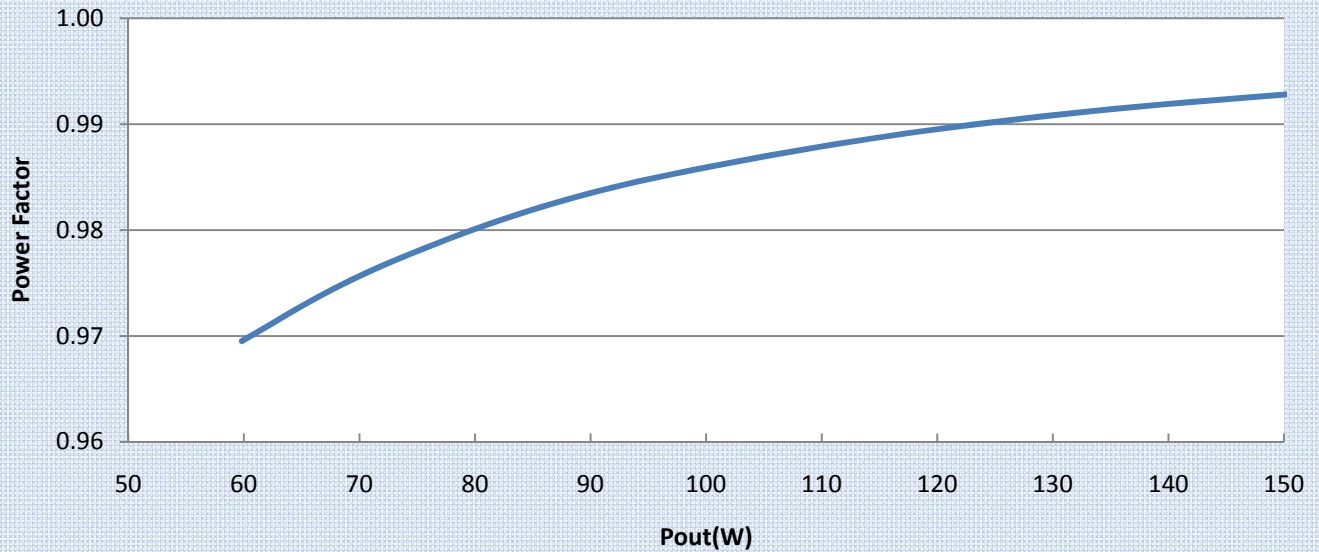

THD VS Pout @ TC 80C @Vin-230V

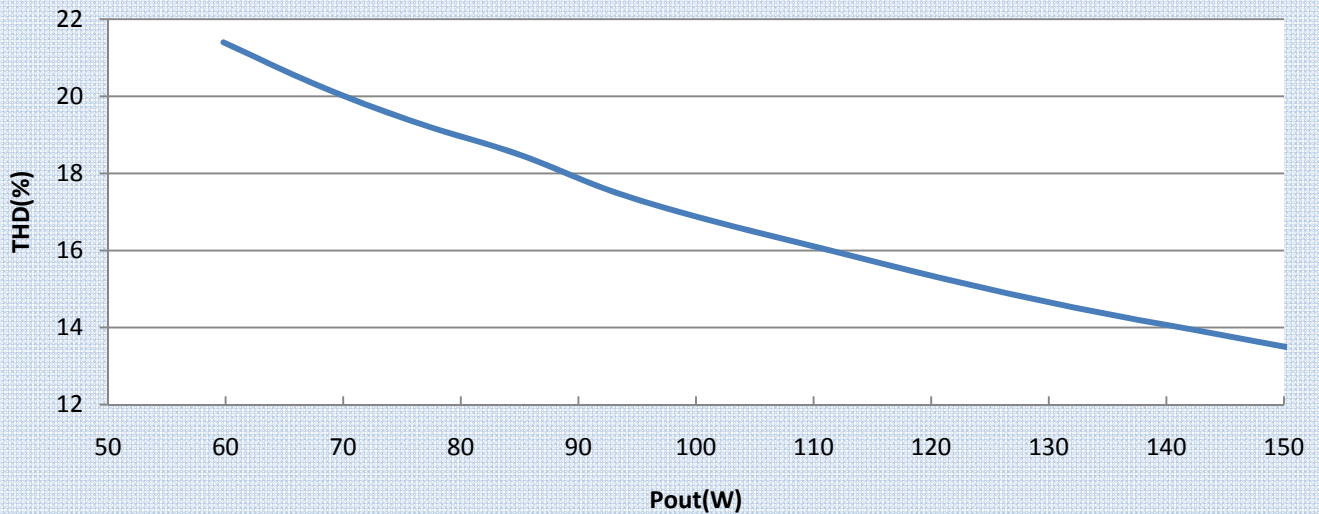

Revised 08/12/2010

PHILIPS LIGHTING N.A.

10275 WEST HIGGINS ROAD · ROSEMONT, IL 60018
Tel: 800-322-2086 · Fax: 888-423-1882 · www.philips.com/advance
Customer Support/Technical Service: 800-372-3331 · OEM Support: 866-915-5886



9137 012 15302

9137 012 15302	
Brand Name	XITANIUM
Description	Xitanium 150W .35/1.41/1.53A I-10V sXt
Input Voltage	220~240
Input Frequency	50/60Hz
RoHS	Yes
Status	Active

Electrical Specifications

lout VS TC of Driver:

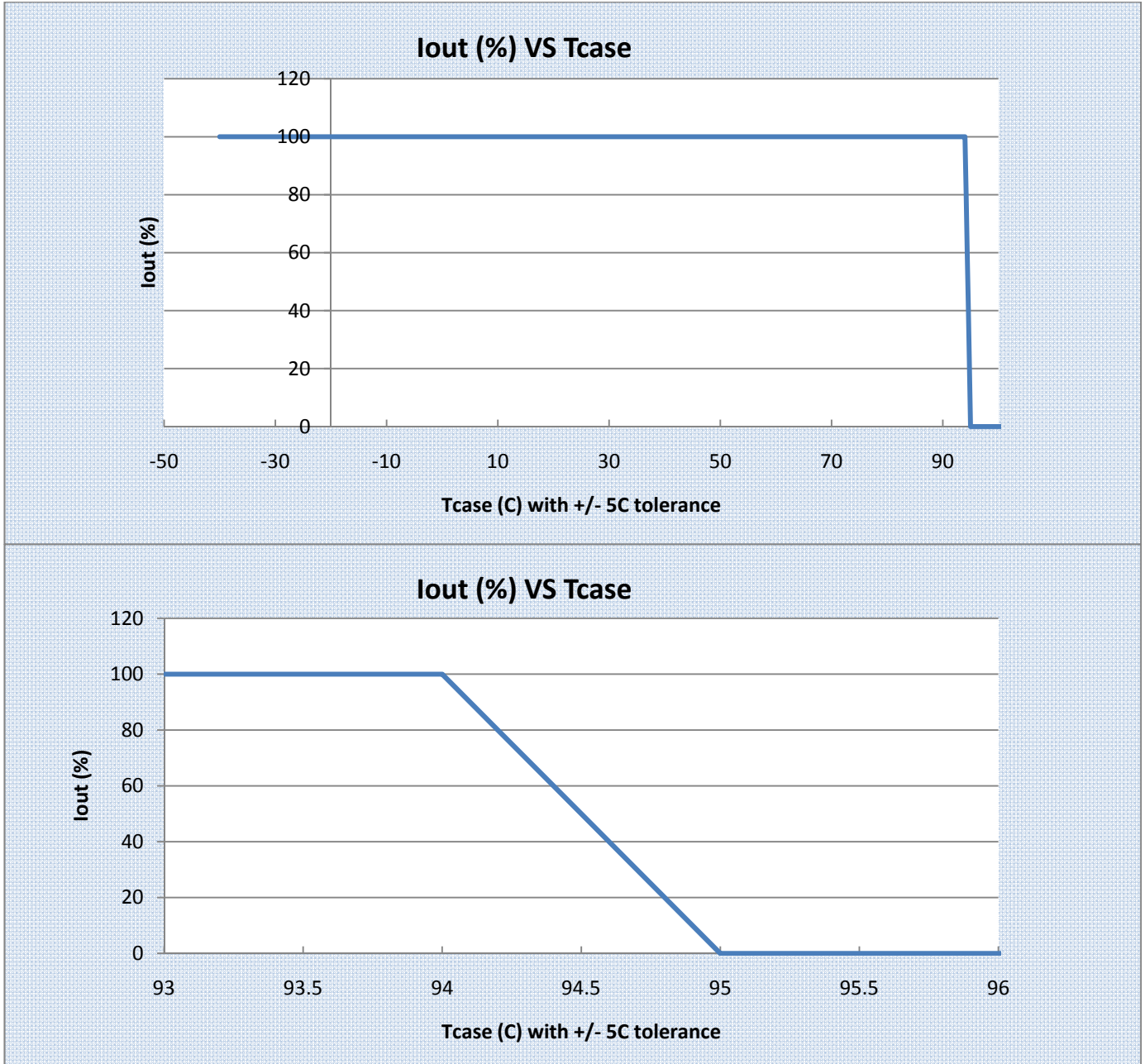

Revised 08/12/2010

PHILIPS LIGHTING N.A.

10275 WEST HIGGINS ROAD · ROSEMONT, IL 60018
Tel: 800-322-2086 · Fax: 888-423-1882 · www.philips.com/advance
Customer Support/Technical Service: 800-372-3331 · OEM Support: 866-915-5886



9137 012 15302

Brand Name	XITANIUM
Description	Xitanium 150W .35/1.41/1.53A I-10V sXt
Input Voltage	220~240
Input Frequency	50/60Hz
RoHS	Yes
Status	Active

Electrical Specifications

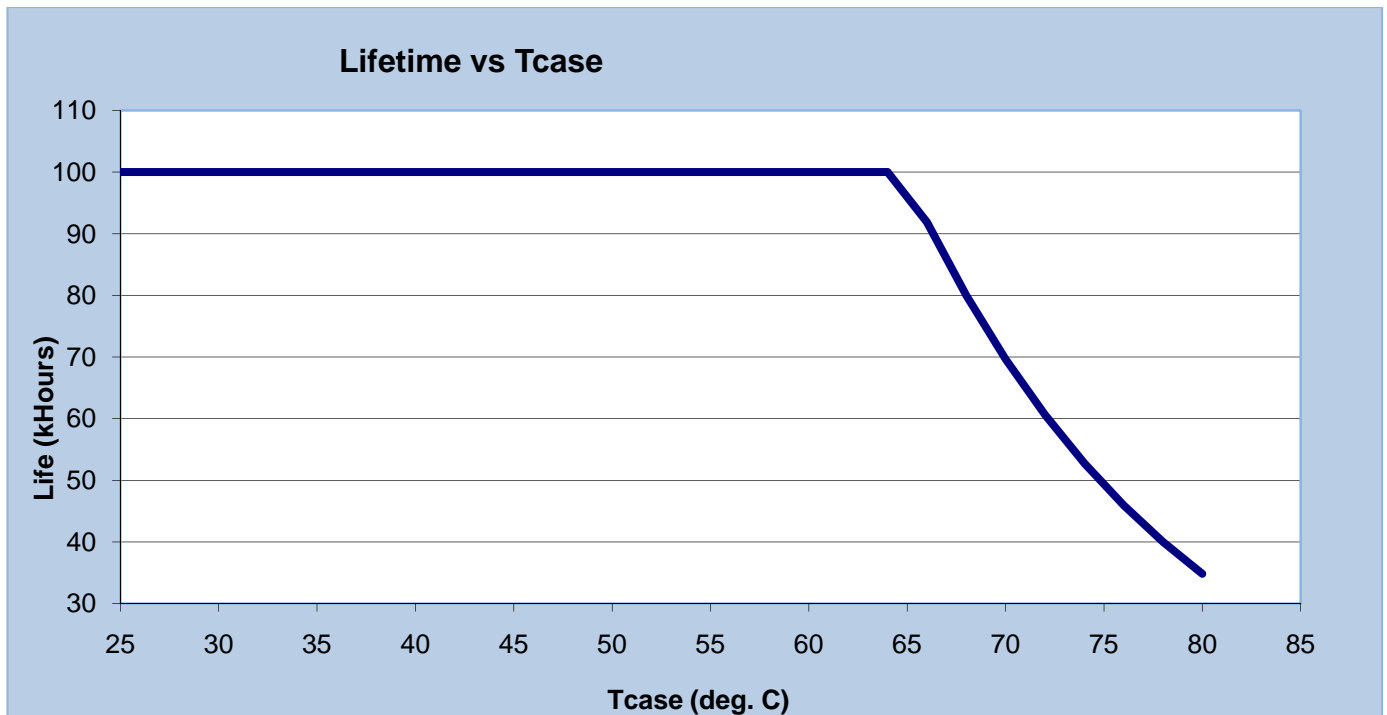

OUTPUT			INPUT			SETTINGS		
Led Out-	BLK		L	BLU		COMM	GRN	
Led Out+	RED		N	BRN		RAOC	YEL	
NTCP	WHT					RTC	BLK/WHT	
NTCN	WHT							
0-10+	VIO							
0-10-	GRY							

Revised 08/12/2010

PHILIPS LIGHTING N.A.

10275 WEST HIGGINS ROAD · ROSEMONT, IL 60018
 Tel: 800-322-2086 · Fax: 888-423-1882 · www.philips.com/advance
 Customer Support/Technical Service: 800-372-3331 · OEM Support: 866-915-5886

9137 012 15302

Brand Name	XITANIUM
Description	Xitanium 150W .35/.41/.53A I-10V sXt
Input Voltage	220~240
Input Frequency	50/60Hz
RoHS	Yes
Status	Active

Electrical Specifications

Inrush Current Info:

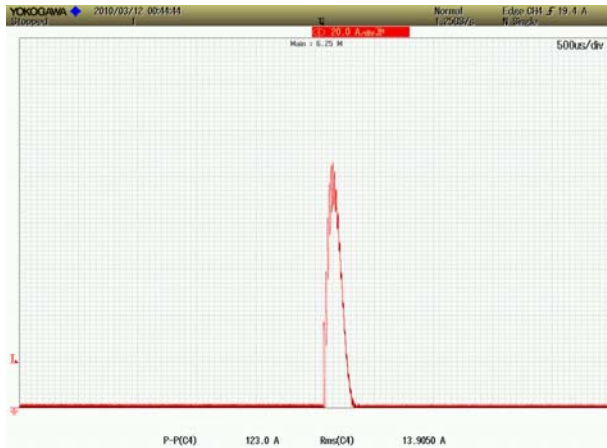

Ipeak	130A
50% Width	140µs

Failure Rate Info:

1. <0.01% per 1kHr @ ≤ Tcase 70C
2. <0.02% per 1kHr @ Tcase between 70C and 80C.

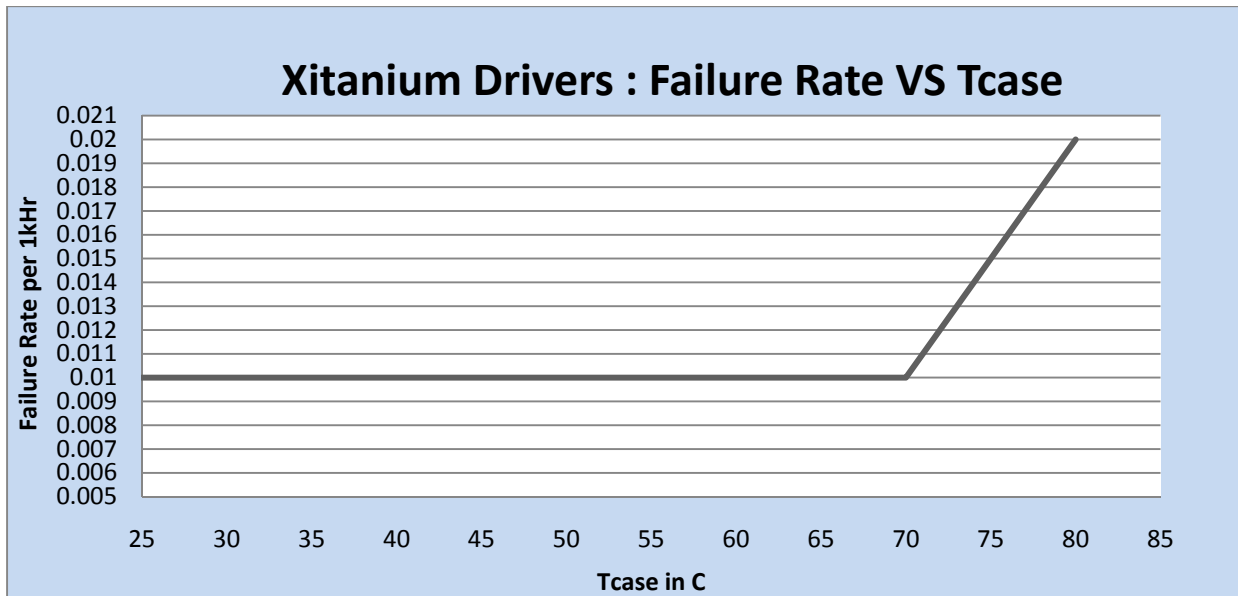

Revised 08/12/2010

PHILIPS LIGHTING N.A.

10275 WEST HIGGINS ROAD · ROSEMONT, IL 60018
 Tel: 800-322-2086 · Fax: 888-423-1882 · www.philips.com/advance
 Customer Support/Technical Service: 800-372-3331 · OEM Support: 866-915-5886