

# Cree® PLCC6 3-in-1 SMD LED CLP6C-RKW/AKW

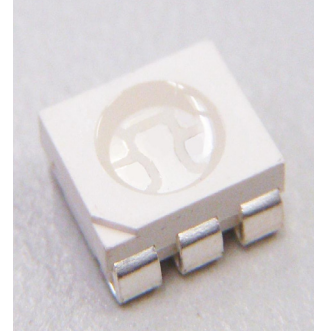

## PRODUCT DESCRIPTION

SMD LEDs is packaged in the industry standard package. These LEDs have high reliability performance and are designed to work under a wide range of environmental conditions.

This high reliability feature makes them ideally suited to be used under illumination application conditions.

Its wide viewing angle makes these LEDs ideally suited for channel letter, or general backlighting and illumination applications. The flat top emitting surface makes it easy for these LEDs to mate with light pipes.

## FEATURES

- Size (mm): 6.0 x 5.0
- Color and Typical Dominant Wavelength:  
Red (624nm)  
Amber (591nm)
- Luminous Intensity (mcd)  
CLP6C-RKW:  
(3550 - 7100)  
CLP6C-AKW:  
(2800 - 7100)
- Viewing angle: 120 degree
- Lead-Free
- RoHS Compliant

## APPLICATIONS

- Light Strip
- Channel Letter
- Backlight

## ABSOLUTE MAXIMUM RATINGS ( $T_A = 25^\circ\text{C}$ )

Items	Symbol	Absolute Maximum Rating	Unit
		Red/Amber	
Forward Current	$I_F$	3 x 80	mA
Peak Forward Current <sup>Note</sup>	$I_{FP}$	3 x 200	mA
Reverse Voltage	$V_R$	5	V
Power Dissipation	$P_D$	3 x 240	mW
Operation Temperature	$T_{opr}$	-40 ~ +100	$^\circ\text{C}$
Storage Temperature	$T_{stg}$	-40 ~ +100	$^\circ\text{C}$
Junction Temperature	$T_J$	110	$^\circ\text{C}$
Junction/Ambient	$R_{THJA}$	3 x 250	$^\circ\text{C/W}$
Junction/Solder Point	$R_{THJS}$	3 x 150	$^\circ\text{C/W}$
Electrostatic Discharge Classification(MIL-STD-883E)	ESD	Class 2	

**Note:** Pulse width  $\leq 0.1$  msec, duty  $\leq 1/10$ .

## TYPICAL ELECTRICAL & OPTICAL CHARACTERISTICS ( $T_A = 25^\circ\text{C}$ )

Characteristics	Color	Symbol	Condition	Unit	Minimum	Typical	Maximum
Forward Voltage	Red/Amber	$V_F$	$I_F = 50$ mA	V		2.4	3.0
Reverse Current	Red/Amber	$I_R$	$V_R = 5$ V	$\mu\text{A}$			10
Dominant Wavelength	Red	$\lambda_D$	$I_F = 3 \times 50$ mA	nm	618	624	630
	Amber	$\lambda_D$	$I_F = 3 \times 50$ mA	nm	584	591	596
Luminous Intensity	Red	$I_v$	$I_F = 3 \times 50$ mA	mcd	3550	4800	
	Amber	$I_v$	$I_F = 3 \times 50$ mA	mcd	2800	4200	
50% Power Angle	Red/Amber	$2\theta_{1/2}$	$I_F = 3 \times 50$ mA	deg		120	

### INTENSITY BIN LIMIT ( $I_F = 3 \times 50 \text{ mA}$ )

Red (CLP6C-RKW)

Bin Code	Min.(mcd)	Max.(mcd)
Yb	3550	4500
Z0	4500	5600
A0	5600	7100

Amber (CLP6C-AKW)

Bin Code	Min.(mcd)	Max.(mcd)
Ya	2800	3550
Yb	3550	4500
Z0	4500	5600
A0	5600	7100

Tolerance of measurement of luminous intensity is  $\pm 10\%$ .

### COLOR BIN LIMIT ( $I_F = 3 \times 50 \text{ mA}$ )

Red (CLP6C-RKW)

Bin Code	Min.(nm)	Max.(nm)
RA	618	630

Amber (CLP6C-AKW)

Bin Code	Min.(nm)	Max.(nm)
AA	584	596

Tolerance of measurement of dominant wavelength is  $\pm 1 \text{ nm}$ .

**ORDER CODE TABLE\***

Color	Kit Number	Viewing Angle	Luminous Intensity (mcd)		Dominant Wavelength			
			Min.	Max.	Color Bin	Min. (nm)	Color Bin	Max. (nm)
Red	CLP6C-RKW-CYbA0AA3	120	3550	7100	RA	618	RA	630
Red	CLP6C-RKW-CZ0A0AA3	120	4500	7100	RA	618	RA	630

Color	Kit Number	Viewing Angle	Luminous Intensity (mcd)		Dominant Wavelength			
			Min.	Max.	Color Bin	Min. (nm)	Color Bin	Max. (nm)
Amber	CLP6C-AKW-CYbB0AA3	120	3550	9000	AA	584	AA	596
Amber	CLP6C-AKW-CZ0B0AA3	120	4500	9000	AA	584	AA	596

Notes:

1. The above kit numbers represent order codes that include multiple intensity-bin and color-bin codes. Only one intensity-bin code and one color-bin code will be shipped on each bulk. Single intensity-bin code and single color-bin codes will not be orderable.
2. Please refer to the "Cree LED Lamp Reliability Test Standards" document for reliability test conditions.
3. Please refer to the "Cree LED Lamp Soldering & Handling" document for information about how to use this LED product safely.

GRAPHS

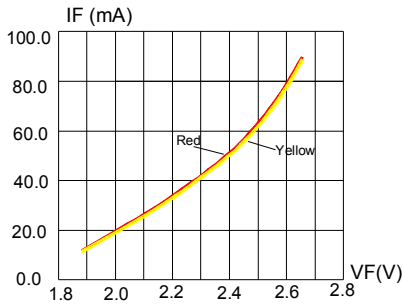

FIG.1 FORWARD CURRENT VS. FORWARD VOLTAGE.

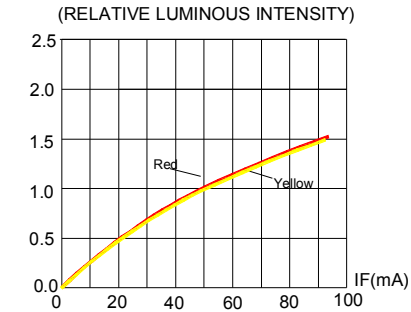

FIG.2 RELATIVE LUMINOUS INTENSITY VS. FORWARD CURRENT

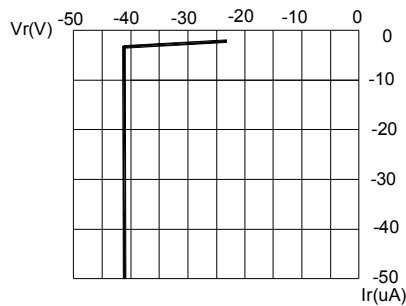

FIG.3 RED & YELLOW REVERSE CURRENT VS. REVERSE VOLTAGE.

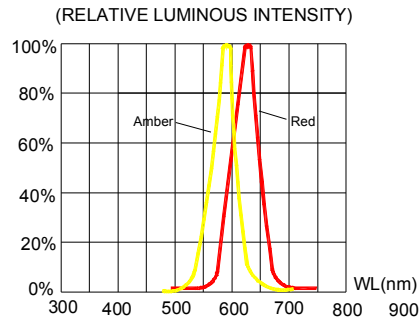

FIG.4 RELATIVE LUMINOUS INTENSITY VS. WAVELENGTH.

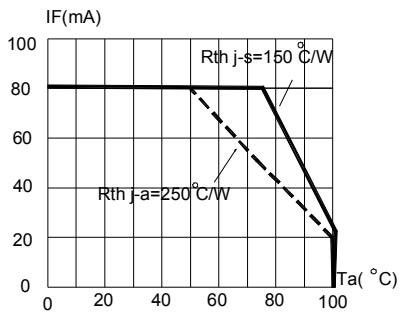

FIG.5 RED & YELLOW MAXIMUM FORWARD DC CURRENT VS AMBIENT TEMPERATURE ( $T_{jmax}=110^{\circ}C$ )

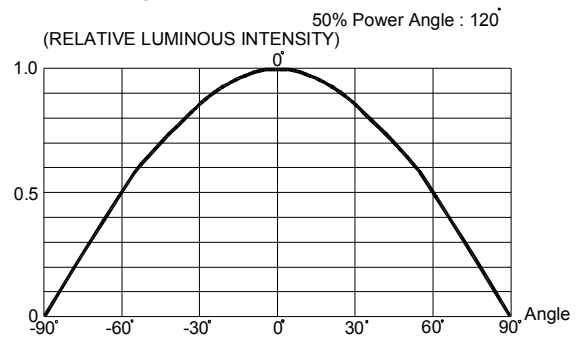
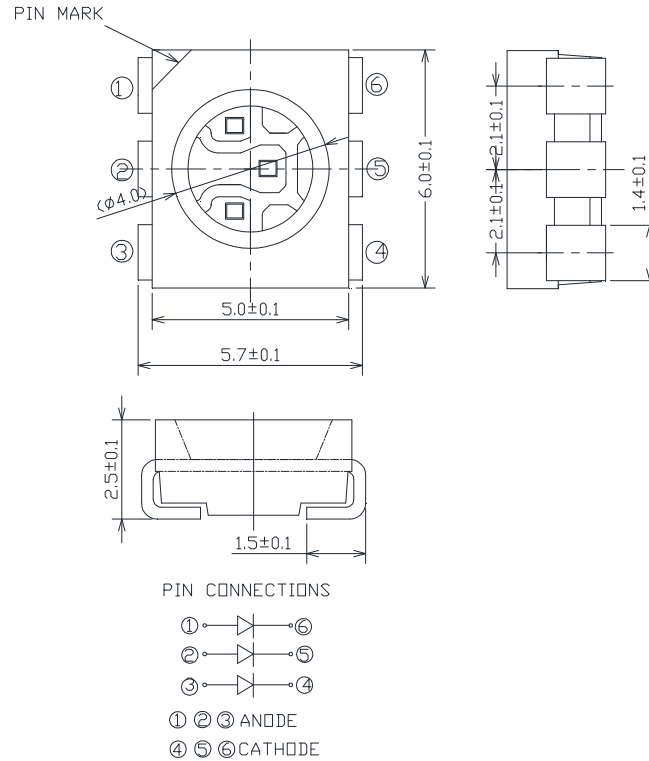

FIG.6 FAR FIELD PATTERN

The above data are collected from statistical figures that do not necessarily correspond to the actual parameters of each single LED. Hence, these data will be changed without further notice.

## MECHANICAL DIMENSIONS

All dimensions are in mm.



## NOTES

### RoHS Compliance

The levels of environmentally sensitive, persistent biologically toxic (PBT), persistent organic pollutants (POP), or otherwise restricted materials in this product are below the maximum concentration values (also referred to as the threshold limits) permitted for such substances, or are used in an exempted application, in accordance with EU Directive 2002/95/EC on the restriction of the use of certain hazardous substances in electrical and electronic equipment (RoHS), as amended through April 21, 2006.

### Vision Advisory Claim

Users should be cautioned not to stare at the light of this LED product. The bright light can damage the eye.

**KIT NUMBER SYSTEM**

Cree LED lamps are tested and sorted into performance bins. A bin is specified by ranges of color, forward voltage, and brightness. Sorted LEDs are packaged for shipping in various convenient options. Please refer to the "Cree LED Lamp Packaging Standard" document for more information about shipping and packaging options.

Cree LEDs are sold by order codes in combinations of bins called kits. Order codes are configured in the following manner:

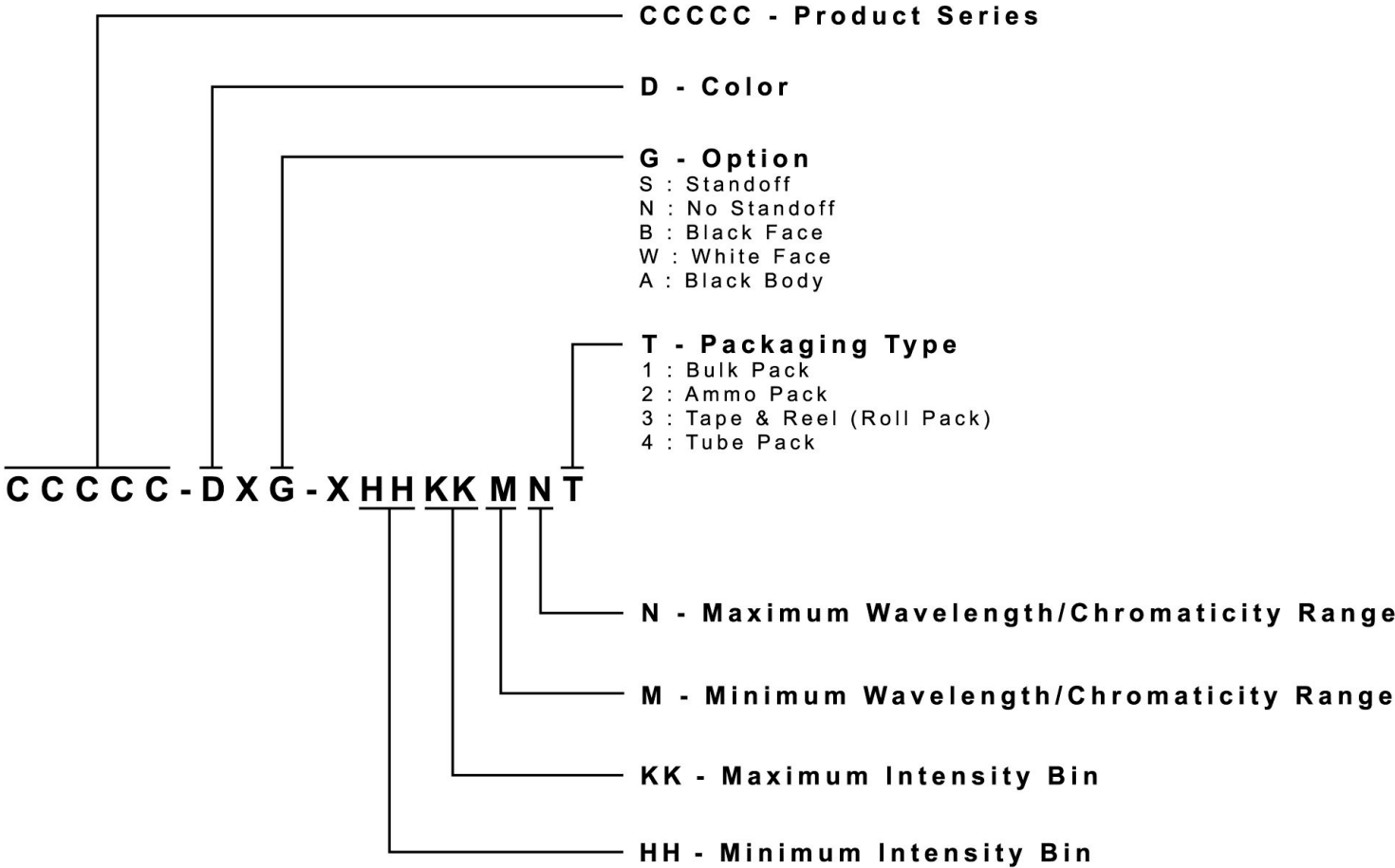

## PACKAGING

- The boxes are not water-resistant, and they must be kept away from water and moisture.
- The LEDs are packed in cardboard boxes after packaging in normal or anti-electrostatic bags.
- Cardboard boxes will be used to protect the LEDs from mechanical shocks during transportation.
- The reel pack is applied in SMD LED.
- Max 900 pcs per reel.

