



ENGLISH

Datasheet

Stock No: 394-437

# RS Pro Toggle Switch DPDT On-Off-On, 5 A@ 120 V ac, 5 A@ 28 V dc, Panel Mount



## Product Details

### Large Lever Toggle Switches

Epoxy sealed terminals prevent contamination during soldering

Chrome Plated Brass actuator

Diallyl Phthalate (DAP) case (UL94V-0)

Silver contacts

### Note

For biased switches '(on)' refers to momentary 'on' position

### Approvals

UL E187490

### Toggle Switches

<b>Momentary function</b> (spring-loaded return):	The switch or contact breaker returns to its original position when the load is removed. E.g. bell push)
<b>Stay-put function:</b>	The switch or contact breaker remains (stop) in the new position after the load has been removed.



## Specifications

**CONTACT RATING:** Dependent upon contact material

**MECHANICAL LIFE:** 40,000 make-and-break cycles.

**CONTACT RESISTANCE:** 10m $\Omega$  max. initial @ 2-4VDC

100mA for both silver and gold plated contacts.

**INSULATION RESISTANCE:** 1,000 M $\Omega$  min.

**DIELECTRIC STRENGTH:** 1,000 Vrms min.@sea level.

**OPERATING TEMPERATURE:** -30°C to 85°C.

## MATERIALS

**CASE:** Diallyl phthalate (DAP) (UL94v-0).

**ACTUATOR:** Brass,chrome plated.











**BUSHING:** Brass, nickel plated.

**HOUSING:** Stainless steel.

**SWITCH SUPPORT:** Brass, tin plated.

**CONTACT / TERMINALS:** Brass, Silver or gold plated.

## Switch Function

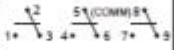
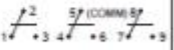
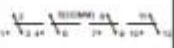
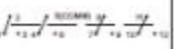
NO. POLES	UL/CSA MODEL NO.	MODEL NO.	SWITCH FUNCTION			CONNECTED TERMINALS / SCHEMATIC		
			POS.1	POS.2	POS.3	POS.1	POS.2	POS.3
								
SP	Q1111	1MS1	ON	NONE	ON	2-3 	N/A	2-1 
	Q1112	1MS2	ON	NONE	MOM			
	Q1113	1MS3	ON	OFF	ON			
	Q1114	1MS4	MOM	OFF	MOM			
	Q1115	1MS5	ON	OFF	MOM			
DP	Q1121	1MD1	ON	NONE	ON	2-3,5-6 	N/A	2-1,5-4 
	Q1122	1MD2	ON	NONE	MOM			
	Q1123	1MD3	ON	OFF	ON			
	Q1124	1MD4	MOM	OFF	MOM			
	Q1125	1MD5	ON	OFF	MOM			
	Q1126	1MD6	ON	ON	ON			
	Q1127	1MD7	MOM	ON	MOM			
	Q1128	1MD8	ON	ON	MOM			
3P	Q1131	1M31	ON	NONE	ON	2-3,5-6,8-9 	N/A	2-1,5-4,8-7 
	Q1132	1M32	ON	NONE	MOM			
	Q1133	1M33	ON	OFF	ON			
	Q1134	1M34	MOM	OFF	MOM			
	Q1135	1M35	ON	OFF	MOM			
4P	Q1141	1M41	ON	NONE	ON	2-3,5-6,8-9,11-12 	N/A	2-1,5-4,8-7,11-10 
	Q1142	1M42	ON	NONE	MOM			
	Q1143	1M43	ON	OFF	ON			
	Q1144	1M44	MOM	OFF	MOM			
	Q1145	1M45	ON	OFF	MOM			
	Q1146	1M46	ON	ON	ON			
	Q1147	1M47	MOM	ON	MOM			
	Q1148	1M48	ON	ON	MOM			

### Pole Options

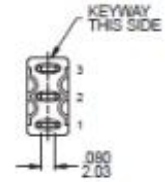
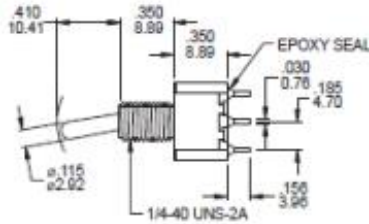
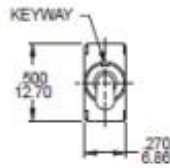

SPDT

Part No. Shown : 1MS1T1B1M1QE

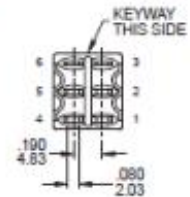
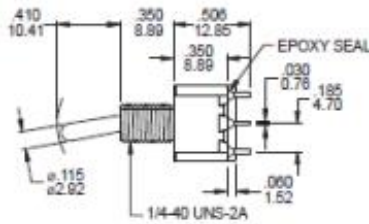
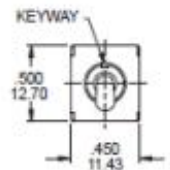

DPDT

Part No. Shown : 1MD1T1B1M1QE

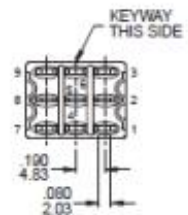
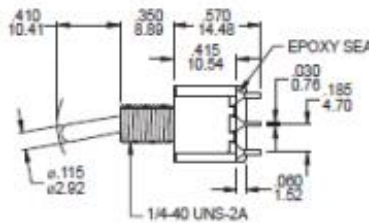
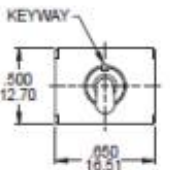

3PDT

Part No. Shown : 1M31T1B1M1QE

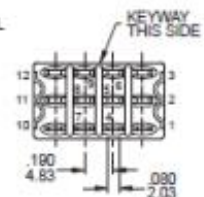
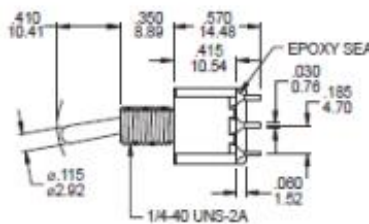
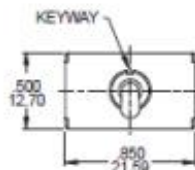

4PDT

Part No. Shown : 1M41T1B1M1QE

### 3-Way Switch

SINGLE POLE, 3 POSITION

Model No.	POS 1	POS 2	POS 3
1MD6	ON	ON	ON
Term. Comm.	2-3,5-6	2-3,5-4	2-1,5-4

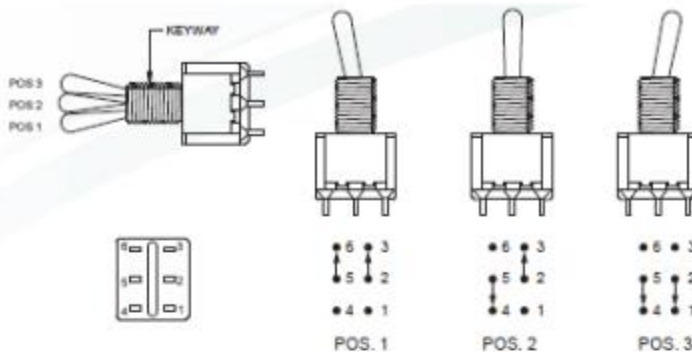

DOUBLE POLE, 3 POSITION

Model No.	POS 1	POS 2	POS 3
1M46	ON	ON	ON
Term. Comm.	2-3,5-6 8-9,11-12	2-3,5-4 8-9,11-10	2-1,5-4 8-7,11-10



### Actuator Options

T1 STD

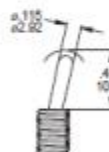

T2

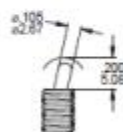

T3

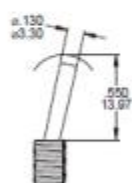

T4

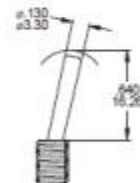

T5



**NOTE** T1 ~ T5 Actuator shown with standard B1 Bushing :  
 Add .070 (1.78) for B3 Bushing ;  
 Subtract .020 (0.51) for B6 Bushing ;  
 Std for M1 , M2 Terminal sub .016 (0.40) for M6 , M7 , VSX

T6 FLATTED WITH ANTIROTATION

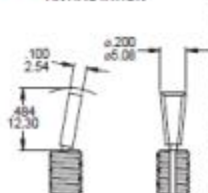

T61

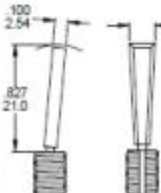

T62

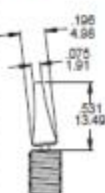

T63

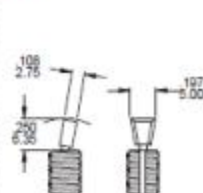

**NOTE** T6,T6-1,T6-2 ,T63 use with B11, B12, B15, B16 bushing only.

# Actuator Options

T7

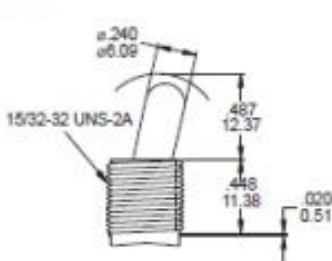

Use with B13 bushing  
Use with B18,B20 the lever is antirotation and the size of lever is 13.00mm

T8

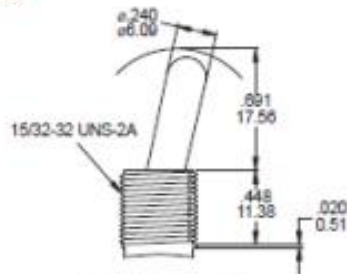

Use with B13 bushing  
Use with B18,B20 the lever is antirotation and the size of lever is 18.00mm

T9

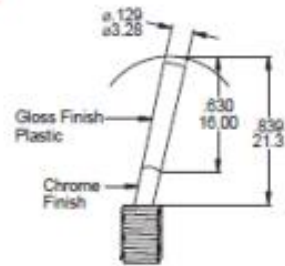

B1 / B2 bushing std with black and red color only ( std. )

TA PLASTIC BLACK

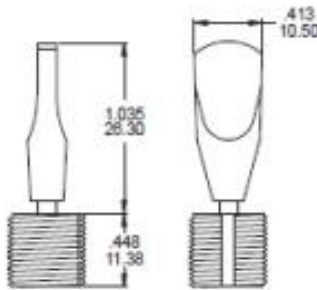

Use with B18 bushing only

T11

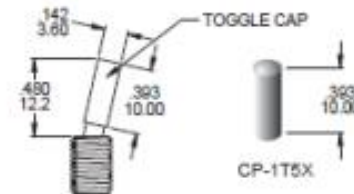

NOTE T11 Actuator shown with standard B1 Bushing ;  
Add .070 ( 1.78 ) for B3 Bushing ;  
Subtract .020 ( 0.51 ) for B6 Bushing.  
Std for M1.M2 Terminal sub .016 ( 0.40 ) for M6.M7.VSX

Plastic No.Color :

ITEM NO	COLOR
1	White
2	Black (Std)
3	Red
4	Orange
5	Yellow
6	Green
7	Blue
8	Brown
9	Gray

T62 , TA , T9 , T11 ACTUATOR ONLY

TL1B25

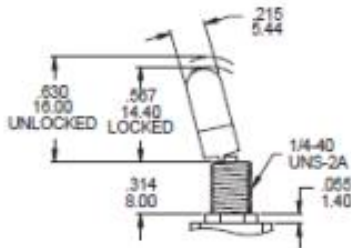

TL2B25

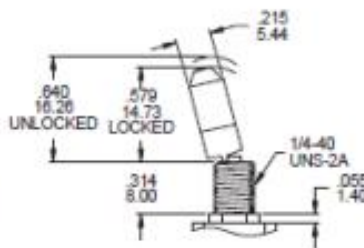

TL3B25

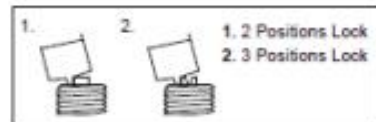
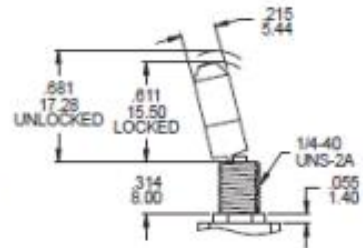

## Bushing Options

B1 THD STD  
B2 NON-THD

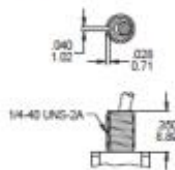

B3 THD  
B4 NON-THD

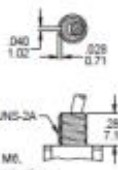

B4 is standard for M6, M7 and V32-5 termination options.

B5 HIGH TORQUE

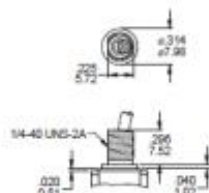

B6 HIGH TORQUE

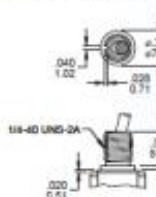

B7 THD STD

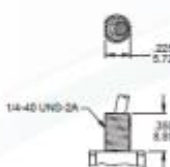

B8 METRIC THD

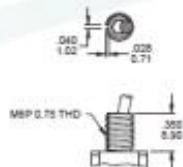

B9 SPLASH PROOF

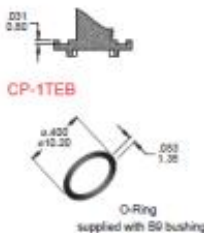
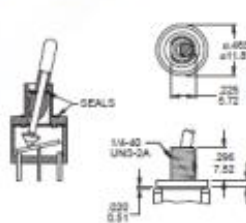

B11 THD STD  
B12 NON-THD

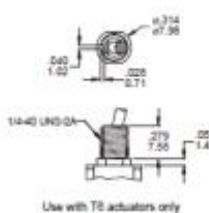

Use with T8 actuators only

B15 THD STD  
B16 NON-THD

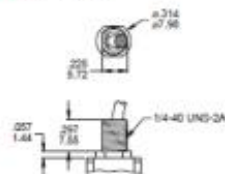

Use with T8 actuators only

B17

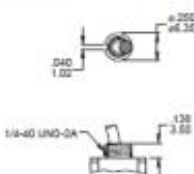

B13

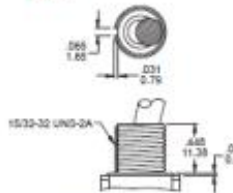

Use with T7, T8 actuators only  
B13 Bear strength from top of actuator up to 10kg aside up to 15kg

B14 SPLASH PROOF

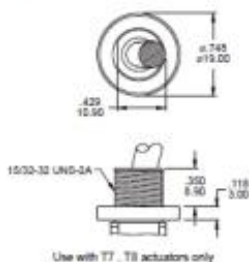

Use with T7, T8 actuators only

B18

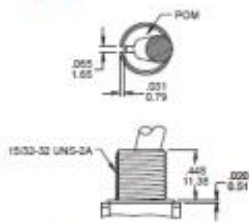

Use with T7, T8 and TA actuators only with Plastic (POM) insert

B20

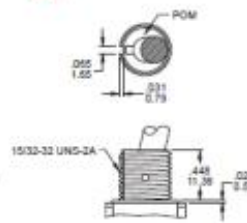

Use with T7, T8 and TA actuators only with Plastic (POM) insert

B18 - B20 Bear strength from top of actuator up to 20kg aside up to 15kg

## Panel Mounting

### 1/4 IN BUSHING



Without locking ring (Keyway)

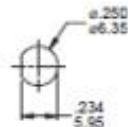

Without locking ring (Flat)

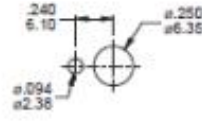

With standard locking ring.

### METRIC BUSHING

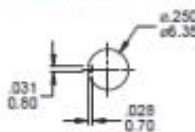

Without locking ring (Keyway)

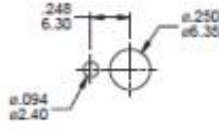

With standard locking ring.

### 15/32 IN BUSHING

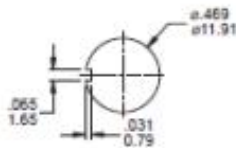

Without locking ring (Keyway)

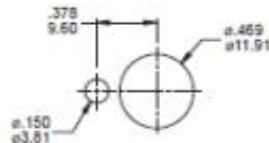

With standard locking ring.

### SPLASH PROOF BUSHING

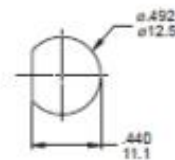

Without locking ring (Flat)

## Termination Options

### M1 Solder lug

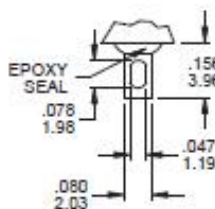

.030(0.76) THK.

### M2 PC Thru-hole

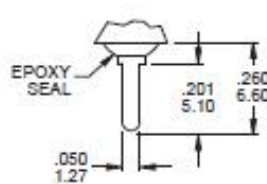

.030(0.76) THK.

### M3 Quick connect

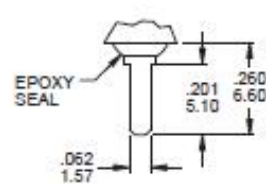

.030(0.76) THK.

### M5 Wire Wrap

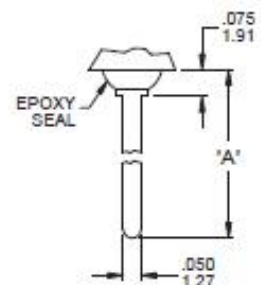

.030(0.76) THK.

M6

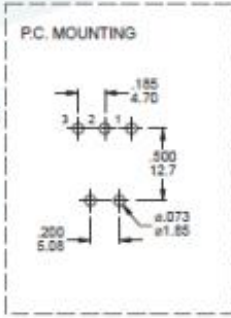
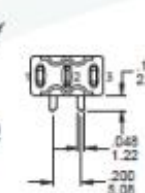
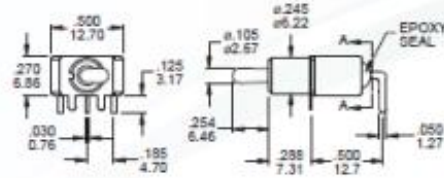

SPDT

Part No. Shown : 1MS1T2B4M6QE

M6

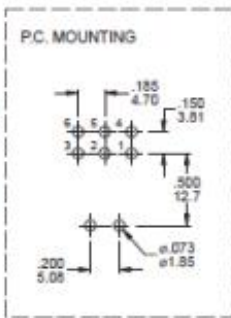
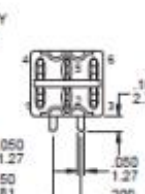
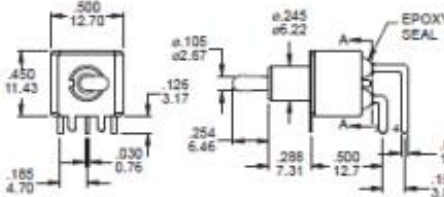

DPDT

Part No. Shown : 1MD1T2B4M6RE

M7

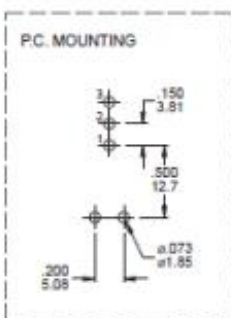
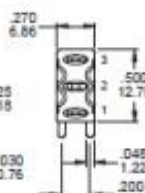
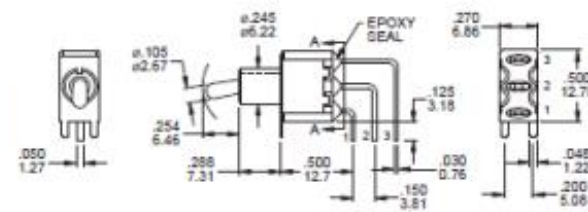

SPDT

Part No. Shown : 1MS1T2B4M7QE

M7

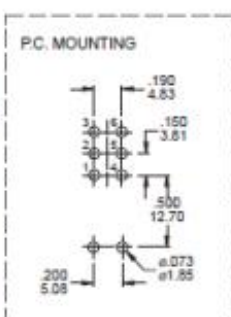
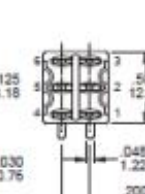
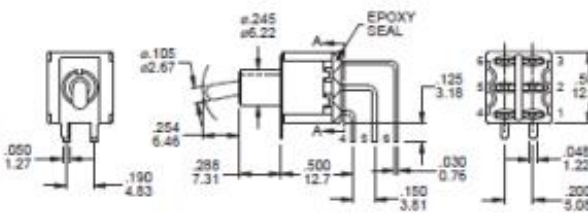

DPDT

Part No. Shown : 1MD1T2B4M7QE

M7

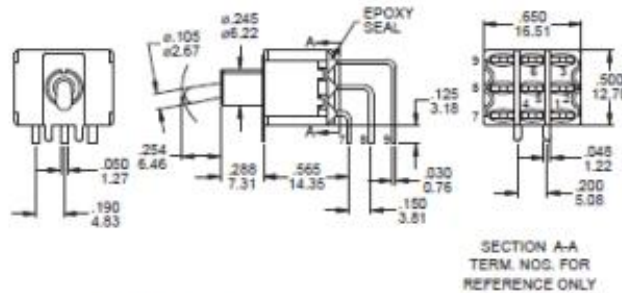

SECTION A-A  
TERM. NOS. FOR  
REFERENCE ONLY

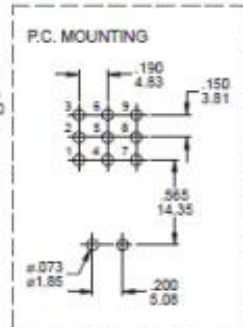

3PDT

Part No. Shown : 1M31T2B4M7QE

M7

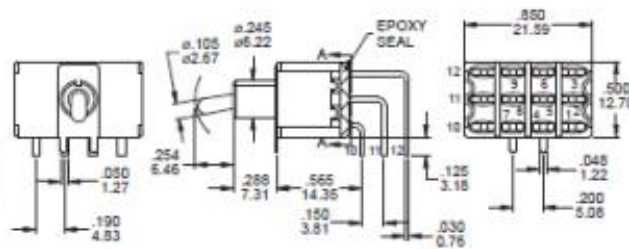

SECTION A-A  
TERM. NOS. FOR  
REFERENCE ONLY

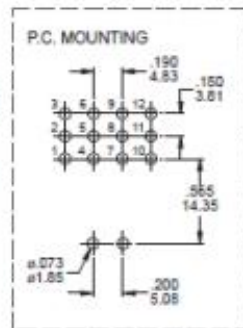

4PDT

Part No. Shown : 1M41T2B4M7QE

VS2 - VS3

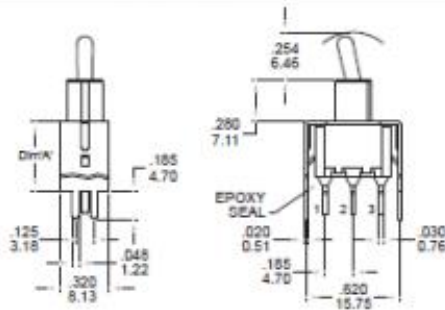

OPTION CODE	DIM. 'A'
VS2	.460 11.68
VS3	.630 16.00

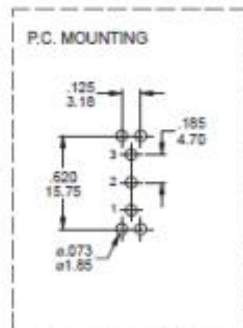

SPDT

Part No. Shown : 1MS1T2B4VS2QE

VS2 - VS3

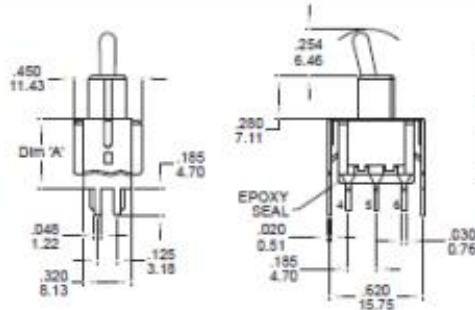

OPTION CODE	DIM. 'A'
VS2	.460 11.68
VS3	.630 16.00

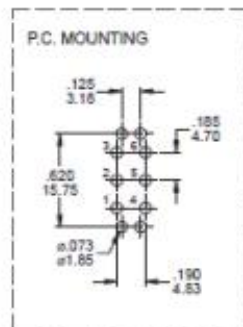

DPDT

Part No. Shown : 1MD1T2B4VS3QE

## Snap – In Termination Options

M6N



V2N



## Hardware

1/4 NUTS HDW2

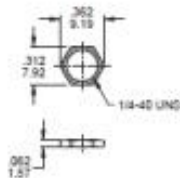

Supplied standard with B1, B3, B5, B6 and B9 options

DRESS NUT HDW3

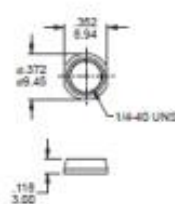

METRIC NUT HDW6

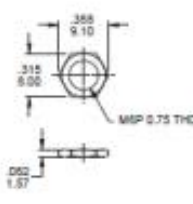

Supplied standard with B6 metric bushing

LOCK WASHER HDW11



Supplied standard with B1 / B3 bushing

OPTIONAL RUBBER HOOD SEALING

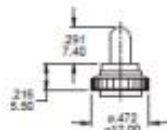

K1=Metric  
E1=Inch (Std.)  
for actuator T1, T2 and B1, B3, B5, B6 Bushing only

15/32 NUTS HDW4

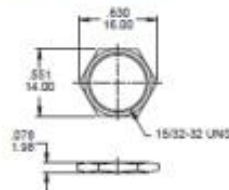

Supplied standard with B13 bushing

LOCK WASHER HDW12



Supplied standard with B13 bushing

HDW15

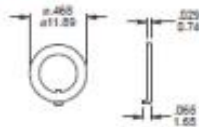

Locking ring supplied standard

HDW16

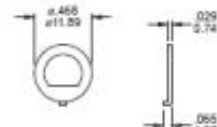

Locking ring supplied with B5 bushing

HDW17

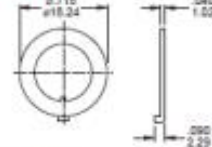

Locking ring supplied with B13, B18, B20 bushing

HDW18

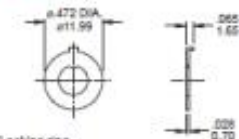

Locking ring supplied with B8 bushing

HDW19

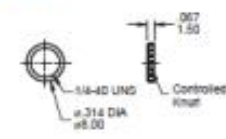

NU-1M15

HDW20

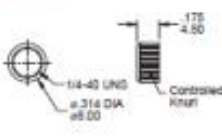

NU-1M24

## Optional Toggle Cap

CP-T1XX



Use with T1

CAP Color :

ITEM NO	COLOR
1	White
2	Black (Std)
3	Red
5	Yellow
6	Green
7	Blue
9	Gray

## Contact Material Options

	CONTACT PLATING	TERMINAL PLATING	RATINGS
<b>Q</b>	Silver	<b>Q</b> = Silver	5 Amps with resistant load @ 120VAC or 28VDC
<b>S</b>		<b>S</b> = Silver,pure - tin	
<b>C</b>	Gold over Silver	<b>C</b> = Gold over silver	2 Amps with resistant load @ 250VAC
<b>K</b>		<b>K</b> = Gold over silver,pure - tin	
<b>R</b>	Gold	<b>R</b> = Gold	0.4 Volt - Amps ( VA ) max. @ 20V max. ( AC or DC )
<b>G</b>		<b>G</b> = Gold,pure - tin	

## Soldering Processes

**MANUAL SOLDERING:** Use soldering iron of 30 watts, controlled at 350°C approximately 5 seconds while applying solder.

**WAVE SOLDERING:** Recommended Soldering Temperature: 260 ± 5°C

Duration of Solder Immersion: Max 5 sec. (PCB is 1.6mm in thickness)