

Cable - VIP-CAB-FLK14/16/1,0M/S7 - 2904515

Please be informed that the data shown in this PDF Document is generated from our Online Catalog. Please find the complete data in the user's documentation. Our General Terms of Use for Downloads are valid (<http://phoenixcontact.com/download>)



Unshielded round cable, for front adapters belonging to the Siemens SIMATIC® "TOP connect" range, with a 16-pos. and 14-pos. (encapsulated) socket strip, for connecting a maximum of 8 channels, cable length: 1.0 m



Key commercial data

Packing unit	1 pc
GTIN	 4 046356 859318
Weight per Piece (excluding packing)	76.3 g
Custom tariff number	85444290
Country of origin	Germany
Note	Made to Order (non-returnable)

Technical data

General

Nominal voltage U_N	< 50 V AC
	60 V DC
Max. current carrying capacity per path	1 A
Max. conductor resistance	0.16 Ω /m
Length of cable	1 m
Single wire, cross section	0.14 mm ²
AWG	26
Conductor construction: Number of litz wires:	7
Single wire, material	Cu tin-plated
External diameter	6.4 mm
Cable, preassembly	Insulation displacement, IEC 60352-4/DIN EN 60352-4
Shielding	no
Outer sheath, material	PVC
External sheath, color	Gray RAL 7035

Environmental conditions

Cable - VIP-CAB-FLK14/16/1,0M/S7 - 2904515

Technical data

Environmental conditions

Ambient temperature (operation)	-20 °C ... 50 °C
Ambient temperature (storage/transport)	-20 °C ... 70 °C
Flame resistance	IEC 60332-1
Resistance to oil	UL 1581
Gasoline resistance	Against occasional splashes

Connector, module side

Number of positions	14
Connectors	IDC/FLK socket strip (2.54 mm)
Number of plugs	1

Connector, controller side

Number of positions	16
Connectors	IDC/FLK socket strip (2.54 mm)
Number of plugs	1

Classifications

eCl@ss

eCl@ss 4.0	27250315
eCl@ss 4.1	27250315
eCl@ss 5.0	27249290
eCl@ss 5.1	27242214
eCl@ss 6.0	27249205
eCl@ss 7.0	27249205
eCl@ss 8.0	27249205

ETIM

ETIM 3.0	EC000830
ETIM 4.0	EC000237
ETIM 5.0	EC000237

UNSPSC

UNSPSC 6.01	26121620
UNSPSC 7.0901	26121620
UNSPSC 11	26121620
UNSPSC 12.01	26121620
UNSPSC 13.2	26121620

Approvals

Approvals

Cable - VIP-CAB-FLK14/16/1,0M/S7 - 2904515

Approvals

Approvals

UL Recognized / cUL Recognized / EAC / cULus Recognized

Ex Approvals

Approvals submitted

Approval details

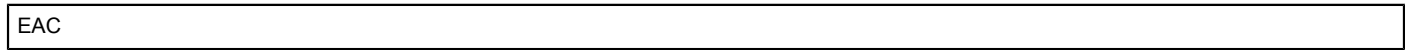

Drawings

Connection diagram

14-pos. Socket strip PIN	16-pos. Socket strip PIN	Wire color
1	16	Black
2	14	Brown
3	12	Red
4	10	Orange
5	8	Yellow
6	6	Green
7	4	Blue
8	2	Violet
9	9	Gray
10	1	White
11	11	White-black
12	3	White-brown
13	13	White-red
14	5	White-orange
	7	-
	15	-

Dimensioned drawing

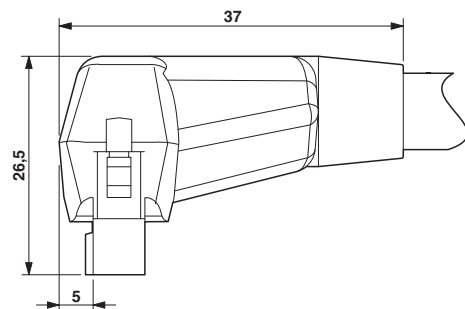

Pin assignment and color code

