



Power and productivity
for a better world™

Initial Order No

Type Code OC25G02PNBN00NU1

Order Code 1SCA126494R1001

EAN Code 6417019564647

Customer Reference



Cam switch configuration

Configuration type	Cam switch configuration
Ampere type	IEC / cULus
Current rating (Ith)	25

Mounting type & Handle type

Chamber System	Normal
Switch Mounting	Door
Handle Mounting	Snap-on
Handle Type	Nose handle
Front Plate	51x51mm / 2.01x2.01in
Handle Colour	Black
Handle IP-protection	IP66

Connections & Options

Connections	Standard box (tunnel) terminals
Gold plated contacts	-
Contact chambers rotated 90 degrees	No
Additional front lettering plate	-
Metallic handle shaft	-

Front plate

Spring Return Function	-
First position	300
Last position	60
Total number of steps	3
Angle system	60 degrees
Stop at last position	Yes

Front plate texts & locking

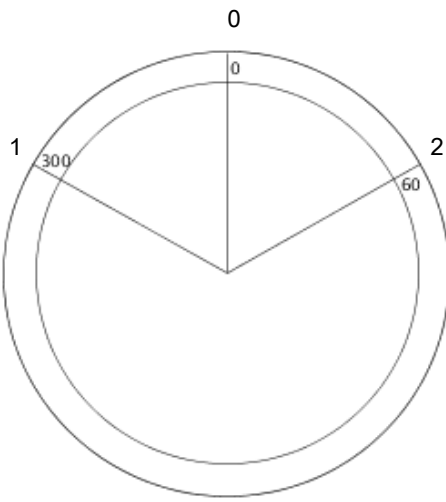

Text layout

Single line
English letters
With ABB logo

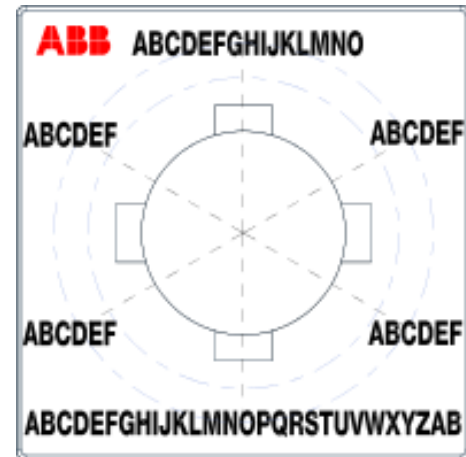



Contact diagram (1)

Number of contacts (1) 2
Use late break / early make -

1 3
/ /
2 4

300	1	X	
0	0		
60	2		X

Connection between

2-4



Power and productivity
for a better world™

Dimension images

mm / in Millimeters [mm]
Inches [in]

Front view

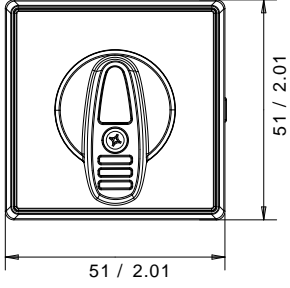

Side view

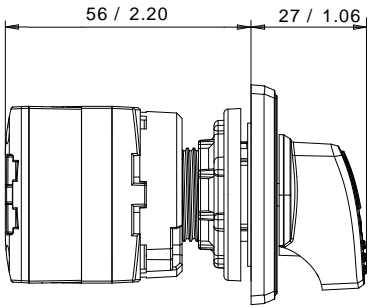

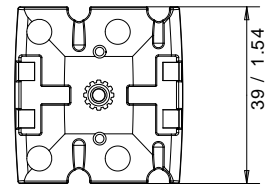

Bottom view



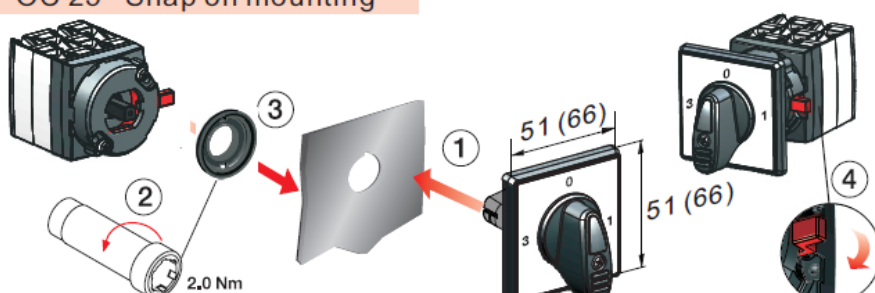
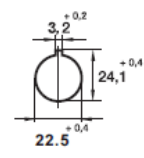
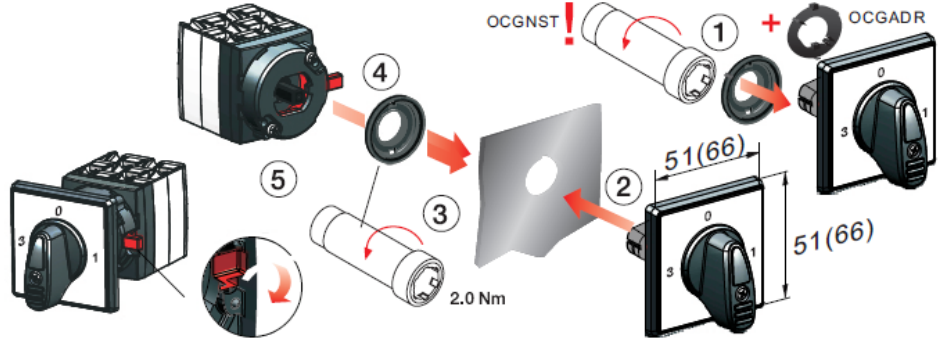
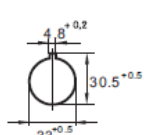

Power and productivity
for a better world™

Mounting instructions

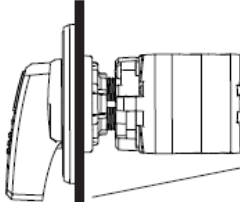
<p>OC 25 Snap on mounting mm</p> 	
<p>OCGNST! OCGADR</p> 	<p>OR</p>  <p>with accessory OCGADR</p>
<p>Terminal Tightening Torque OC 25 1,2Nm(PH1) Wire Range-No 16 - 12AWG 1.5 - 4mm²</p> 	 <p>Door thickness 0,5 - 5,5 mm</p>



Technical data, Rotary cam switches OC 10...25 Amperes

Ratings according to IEC60947-3

				OC10	OC25	
Rated insulation voltage	U_i	Pollution degree 3	V	500	690	
Rated impulse withstand voltage	U_{imp}		kV	2,5	4	
Rated thermal current	I_{th}		A	10	25	
Rated conditional short circuit current	I_p (r.m.s.)		kA	1 ¹⁾	7 ¹⁾	
Max back-up fuse link			A	10	25	
Rated short time withstand current	r.m.s. -value I_{sw}	1s	A	120	300	
		3s	A	70	173	
Conditional short circuit current	I_q	500 V	kA	3	-	
		690 V	kA	-	7	
Rated operational current	AC-21A 1 and 3-phase	400 V	A	10	25	
		Up to 500V	A	10	20	
	500...690 V	A	-	20		
	AC-23A 3-phase	230 V	A	7,6	15	
		400 V	A	6,5	15	
		500 V	A	-	8,1	
		690 V	A	-	5,9	
	AC-23A 1-phase	230 V	A	7,2	8,7	
		400 V	A	6,1	8,3	
	AC-3 3-phase	230 V	A	7,6	12	
		400 V	A	4,9	12	
		500 V	A	-	6,8	
		690 V	A	-	4,9	
	AC-3 1-phase	230 V	A	5,3	7,2	
		400 V	A	4,2	7,2	
	AC-4 3-phase	380...440 V	A	1,4	7,7	
		660...690 V	A	-	3,8	
	Rated operational power ⁴⁾	AC-23A 3-phase	230 V	kW	1,8	2,6
			400 V	kW	3	7,5
			500 V	kW	-	4,8
690 V			kW	-	4,8	
AC-23A 1-phase		230 V	kW	0,8	0,9	
		400 V	kW	1,1	1,5	
AC-3 3-phase		230 V	kW	1,8	2,2	
		400 V	kW	2,2	5,5	
		500 V	kW	-	4	
		690 V	kW	-	4	
AC-3 1-phase		230 V	kW	0,6	0,8	
		400 V	kW	0,8	1,3	
AC-4 3-phase		380...440 V	kW	0,55	4	
		660...690 V	kW	-	3	
Rated operational current, DC-21A		1-contact in series	48 V	A	10	25
Time constant 0...1ms		1-contact in series	110 V	A	0,7	1,5
		1-contact in series	220 V	A	0,3	0,5
		2-contact in series	60 V	A	10	20
		3-contact in series	110 V	A	10	20
		5-contact in series	220 V	A	10	20
	9-contact in series	440 V	A	10	20	
	10-contact in series	600 V	A	-	16	
Rated operational current, DC-22A	1-contact in series	24 V	A	6	10	
Time constant 1...50ms	1-contact in series	30 V	A	3	4,5	
	1-contact in series	40 V	A	3	4,5	
	2-contact in series	60 V	A	3	4,5	
	3-contact in series	110 V	A	3	4,5	
	5-contact in series	220 V	A	3	4,5	



Rated operational current, DC-13	1 contact in series	48 V	A	-	3
	1 contact in series	110 V	A	-	0,8
	1 contact in series	220 V	A	-	0,4
Rated operational current, according to IEC60947-5-1	AC-15	220...240 V	A	2,5	5,5
		380...440 V	A	1,5	3,5
Power loss per contact - at rated I_{th}	Standard contacts		W	≤ 0.6	≤ 1.8
Contact resistance	Standard contacts		Ohms	≤ 0.004	≤ 0.003
Power loss per contact - at rated I_{th}	Gold contacts		W	0,4	≤ 1.8
Contact resistance	Gold contacts		Ohms	≤ 0.006	≤ 0.003
Minimum switching capacity	Gold contacts		mA	5	5
	Gold contacts		V AC/DC	5	5
Terminals	Max cable cross section, solid/stranded ³⁾		mm ²	0.5...1.5	1.5...4
Mechanical endurance ⁵⁾	8 Contacts and less		Number	500 000	500 000
	9 to 14 Contacts		of	300 000	300 000
	15-24 Contacts		operations	100 000	100 000
Temperature	Storing and operational ²⁾ temperature		°C	-40...+80	-40...+85

¹⁾ 400 V

²⁾ At 40°C, derating 0%. Current peaks up to 60°C, derating 0%.

³⁾ Use copper wire only

⁴⁾ These values are given for guidance and may vary acc. to the motor manufacturer

⁵⁾ The mechanical endurance ratings are dependent on the switching angles and the number of contacts. The ratings shown represent the minimum values achieved. Higher ratings may be available upon request..

Ratings according to UL 60947-4-1

Standards UL 60947-1, UL 60947-4-1, CSA C22.2 no. 60947-1-13, CSA C22.2 no. 60947-4-1-14.

Model designation		OC10	OC25	
Maximum general use ratings:				
Pilot duty, V ac	V ac	A300	A600	
General rating, A	A	10	25	
Voltage rating, 50/60 Hz, V ac	V ac	300	600	
Single phase horsepower ratings				
Voltage, V ac, 50/60 Hz	120 V	HP	0,33	0,75
		FLA	7,2	13,8
	240 V	HP	1	2
		FLA	8	12
	480 V	HP	-	3
		FLA	-	8,5
	600 V	HP	-	3
		FLA	-	6,8
Three phase horsepower ratings				
Voltage, V ac, 50/60 Hz	120 V	HP	1	2
		FLA	8,4	13,6
	240 V	HP	1	3
		FLA	4,2	9,6
	480 V	HP	-	5
		FLA	-	7,6
	600 V	HP	-	7,5
		FLA	-	9
Short circuit ratings, manual motor controllers				
Short circuit ratings		1 kA rms, 300 Vac	5 kA rms, 600 Vac	
Maximum fuse size (Fuse class)		30 A (RK5)	35 A (RK5)	
Cabling				
Wire range	AWG	14**	14-10**	

** Solid or stranded copper conductors only

The standard for Industrial Control Equipment UL 508 has been harmonized with the relevant product standards of the IEC standard for Low-Voltage Switchgear and Controlgear IEC 60947.