

Cree® PLCC2 1-in-1 SMD LED CLM1C-WKW



PRODUCT DESCRIPTION

SMD LEDs is packaged in the industry standard package. These LEDs have high reliability performance and are designed to work under a wide range of environmental conditions.

This high reliability feature makes them ideally suited to be used under illumination application conditions.

Its wide viewing angle makes these LEDs ideally suited for channel letter, or general backlighting and illumination applications. The flat top emitting surface makes it easy for these LEDs to mate with light pipes.

FEATURES

- Size (mm): 3.2 x 2.7
- Color Temperatures(K):
Cool White :
Min . (4600) / Typical (6800)
- Luminous Intensity (mcd)
CLM1C-WKW:(900 - 2800)
- Moisture Sensitivity Level: 5a
- Lead-Free
- RoHS Compliant

APPLICATIONS

- Light Strip
- Channel Letter

ABSOLUTE MAXIMUM RATINGS ($T_A = 25^\circ\text{C}$)

Items	Symbol	Absolute Maximum Rating	Unit
Forward Current	I_F	25	mA
Peak Forward Current ^{Note}	I_{FP}	100	mA
Reverse Voltage	V_R	5	V
Power Dissipation	P_D	100	mW
Operation Temperature	T_{opr}	-40 ~ +100	$^\circ\text{C}$
Storage Temperature	T_{stg}	-40 ~ +100	$^\circ\text{C}$
Junction Temperature	T_J	110	$^\circ\text{C}$
Junction/Ambient	R_{THJA}	450	$^\circ\text{C}/\text{W}$
Junction/Solder Point	R_{THJS}	300	$^\circ\text{C}/\text{W}$

Note: Pulse width ≤ 0.1 msec, duty $\leq 1/10$.

TYPICAL ELECTRICAL & OPTICAL CHARACTERISTICS ($T_A = 25^\circ\text{C}$)

Characteristics	Symbol	Condition	Unit	Minimum	Typical	Maximum
Forward Voltage	V_F	$I_F = 20$ mA	V		3.2	4.0
Reverse Current	I_R	$V_R = 5$ V	μA			10
Luminous Intensity	I_V	$I_F = 20$ mA	mcd	710	1800	
Chromaticity Coordinates	x	$I_F = 20$ mA			0.3100	
	y	$I_F = 20$ mA			0.3200	

INTENSITY BIN LIMIT ($I_F = 20 \text{ mA}$)

Cool White

Bin Code	Min.(mcd)	Max.(mcd)
Vb	900	1120
Wa	1120	1400
Wb	1400	1800
Xa	1800	2240
Xb	2240	2800

Tolerance of measurement of luminous intensity is $\pm 10\%$.**VF BIN LIMIT ($I_F = 20 \text{ mA}$)**

Cool White

Bin Code	Min.(V)	Max.(V)
27	2.8	3.0
28	3.0	3.2
29	3.2	3.4
2a	3.4	3.6
2b	3.6	3.8
2c	3.8	4.0

Tolerance of measurement of VF is $\pm 0.05\text{V}$.

COLOR BIN LIMIT ($I_f = 20 \text{ mA}$)

Cool White

Bin Code	Sub-bin	x	y
W1	Wa	0.2545	0.2480
		0.2633	0.2410
		0.2545	0.2245
		0.2450	0.2290
	Wb	0.2633	0.2410
		0.2720	0.2340
		0.2640	0.2200
		0.2545	0.2245
	Wc	0.2545	0.2480
		0.2640	0.2670
		0.2720	0.2575
		0.2633	0.2410
	Wd	0.2633	0.2410
		0.2720	0.2575
		0.2800	0.2480
		0.2720	0.2340
W2	We	0.2640	0.2670
		0.2735	0.2860
		0.2808	0.2740
		0.2720	0.2575
	Wf	0.2720	0.2575
		0.2808	0.2740
		0.2880	0.2620
		0.2800	0.2480
	Wg	0.2735	0.2860
		0.2830	0.3050
		0.2895	0.2905
		0.2808	0.2740
	Wh	0.2808	0.2740
		0.2895	0.2905
		0.2960	0.2760
		0.2880	0.2620

Bin Code	Sub-bin	x	y
W3	Wj	0.2830	0.3050
		0.2950	0.3210
		0.2998	0.3028
		0.2895	0.2905
	Wk	0.2895	0.2905
		0.2998	0.3028
		0.3045	0.2865
		0.2960	0.2760
	Wm	0.2950	0.3210
		0.3070	0.3370
		0.3100	0.3150
		0.2998	0.3028
	Wn	0.2998	0.3028
		0.3100	0.3150
		0.3130	0.2970
		0.3045	0.2865
W4	Wp	0.3070	0.3370
		0.3185	0.3485
		0.3200	0.3270
		0.3100	0.3150
	Wq	0.3100	0.3150
		0.3200	0.3270
		0.3215	0.3075
		0.3130	0.2970
	Wr	0.3185	0.3485
		0.3300	0.3600
		0.3300	0.3390
		0.3200	0.3270
	Ws	0.3200	0.3270
		0.3300	0.3390
		0.3300	0.3180
		0.3215	0.3075

Bin Code	Sub-bin	x	y
W5	Wt	0.3300	0.3600
		0.3455	0.3725
		0.3443	0.3535
		0.3300	0.3390
	Wu	0.3300	0.3390
		0.3443	0.3535
		0.3430	0.3345
		0.3300	0.3180
	Wv	0.3455	0.3725
		0.3610	0.3850
		0.3585	0.3680
		0.3443	0.3535
	Ww	0.3443	0.3535
		0.3585	0.3680
		0.3560	0.3510
		0.3430	0.3345

Tolerance of measurement of the color coordinates is ± 0.01 .

CIE CHROMATICITY DIAGRAM

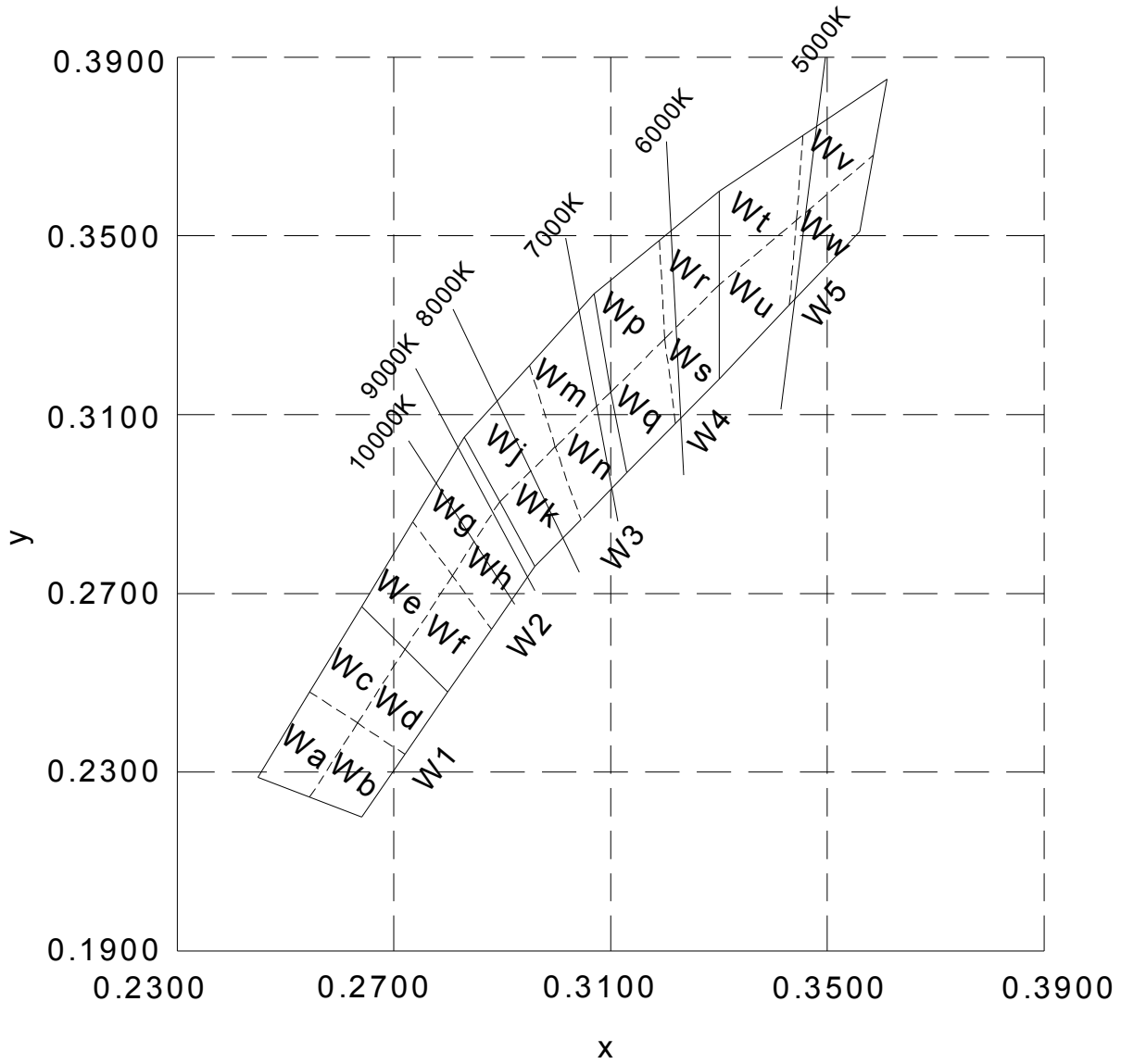

ORDER CODE TABLE*

Color	Kit Number	Luminous Intensity (mcd)		Color Bin Code
		Min.	Max.	
Cool white	CLM1C-WKW-CVbXb153	900	2800	W1,W2,W3,W4,W5
Cool white	CLM1C-WKW-CWaXb153	1120	2800	W1,W2,W3,W4,W5
Cool white	CLM1C-WKW-CWaXb233	1120	2800	W2,W3
Cool white	CLM1C-WKW-CWaXb453	1120	2800	W4,W5
Cool white	CLM1C-WKW-CWbXb153	1400	2800	W1,W2,W3,W4,W5
Cool white	CLM1C-WKW-CWbXb233	1400	2800	W2,W3
Cool white	CLM1C-WKW-CWbXb453	1400	2800	W4,W5
Cool white	CLM1C-WKW-CWbXa153	1400	2240	W1,W2,W3,W4,W5
Cool white	CLM1C-WKW-CWbXa233	1400	2240	W2,W3
Cool white	CLM1C-WKW-CWbXa453	1400	2240	W4,W5

Notes:

1. The above kit numbers represent order codes that include multiple intensity-bin and color-bin codes. Only one intensity-bin code and one color-bin code will be shipped on each bulk. Single intensity-bin code and single color-bin codes will not be orderable.
2. Please refer to the "Cree LED Lamp Reliability Test Standards" document for reliability test conditions.
3. Please refer to the "Cree LED Lamp Soldering & Handling" document for information about how to use this LED product safely.

GRAPHS

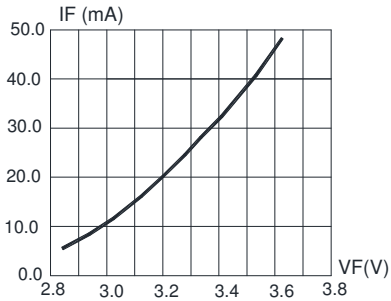

FIG.1 FORWARD CURRENT VS. FORWARD VOLTAGE.

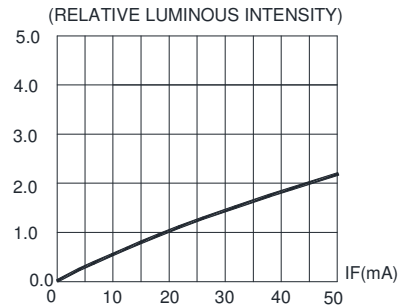

FIG.2 RELATIVE LUMINOUS INTENSITY VS. FORWARD CURRENT

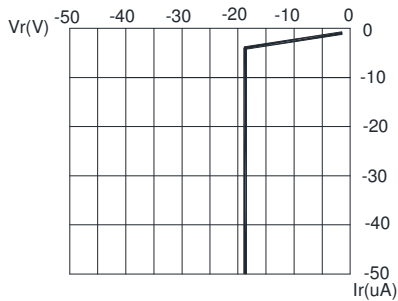

FIG.3 REVERSE CURRENT VS. REVERSE VOLTAGE.

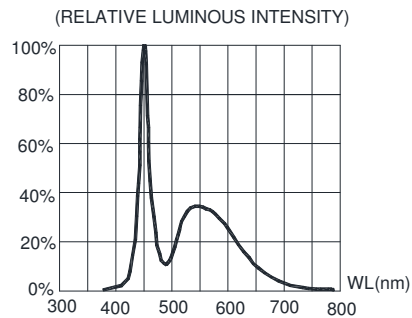

FIG.4 RELATIVE LUMINOUS INTENSITY VS. WAVELENGTH.

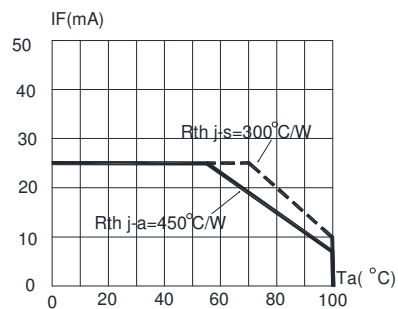

FIG.5 MAXIMUM FORWARD DC CURRENT VS AMBIENT TEMPERATURE ($T_{jmax}=110^{\circ}C$)

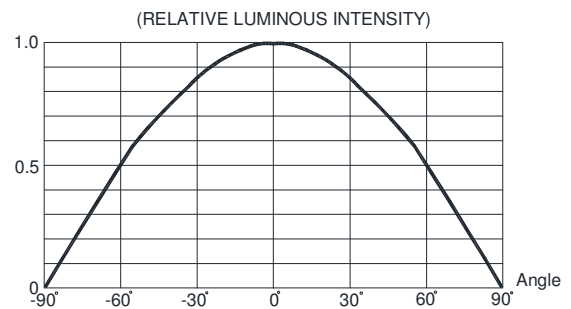
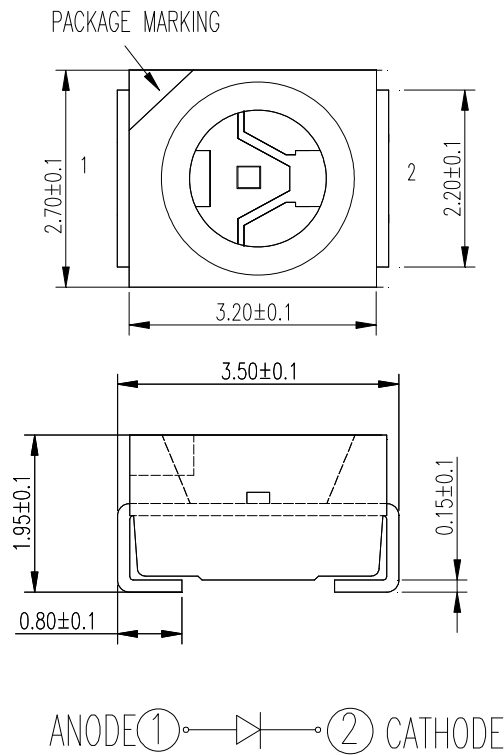

FIG.6 FAR FIELD PATTERN

The above data are collected from statistical figures that do not necessarily correspond to the actual parameters of each single LED. Hence, these data will be changed without further notice.

MECHANICAL DIMENSIONS

All dimensions are in mm.



NOTES

RoHS Compliance

The levels of environmentally sensitive, persistent biologically toxic (PBT), persistent organic pollutants (POP), or otherwise restricted materials in this product are below the maximum concentration values (also referred to as the threshold limits) permitted for such substances, or are used in an exempted application, in accordance with EU Directive 2002/95/EC on the restriction of the use of certain hazardous substances in electrical and electronic equipment (RoHS), as amended through April 21, 2006.

Vision Advisory Claim

Users should be cautioned not to stare at the light of this LED product. The bright light can damage the eye.

KIT NUMBER SYSTEM

Cree LED lamps are tested and sorted into performance bins. A bin is specified by ranges of color, forward voltage, and brightness. Sorted LEDs are packaged for shipping in various convenient options. Please refer to the "Cree LED Lamp Packaging Standard" document for more information about shipping and packaging options.

Cree LEDs are sold by order codes in combinations of bins called kits. Order codes are configured in the following manner:

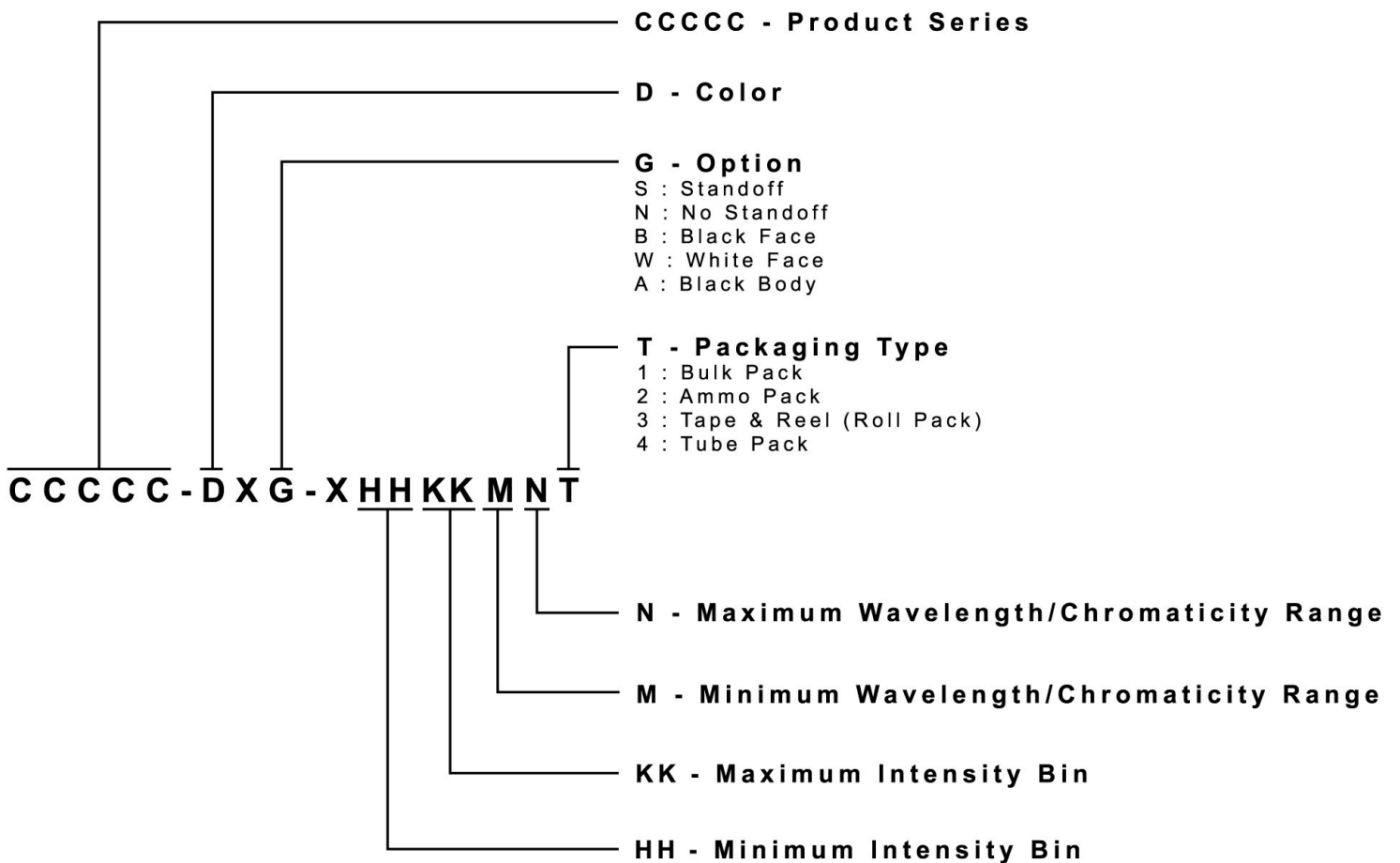

PACKAGING

- The boxes are not water resistant and they must be kept away from water and moisture.
- The LEDs are packed in cardboard boxes after packaging in normal or anti-electrostatic bags.
- Cardboard boxes will be used to protect the LEDs from mechanical shocks during transportation.
- The reel pack is applied in SMD LED.
- Max 2000 pcs per reel.

