



Datasheet

ENGLISH

New 5.0mm Header Vertical with Flanges 15A

RS Stock 874-4957

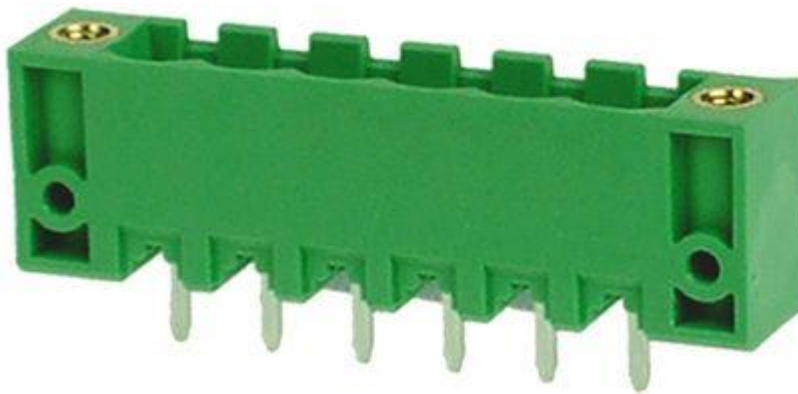

Dimensions: (mm)

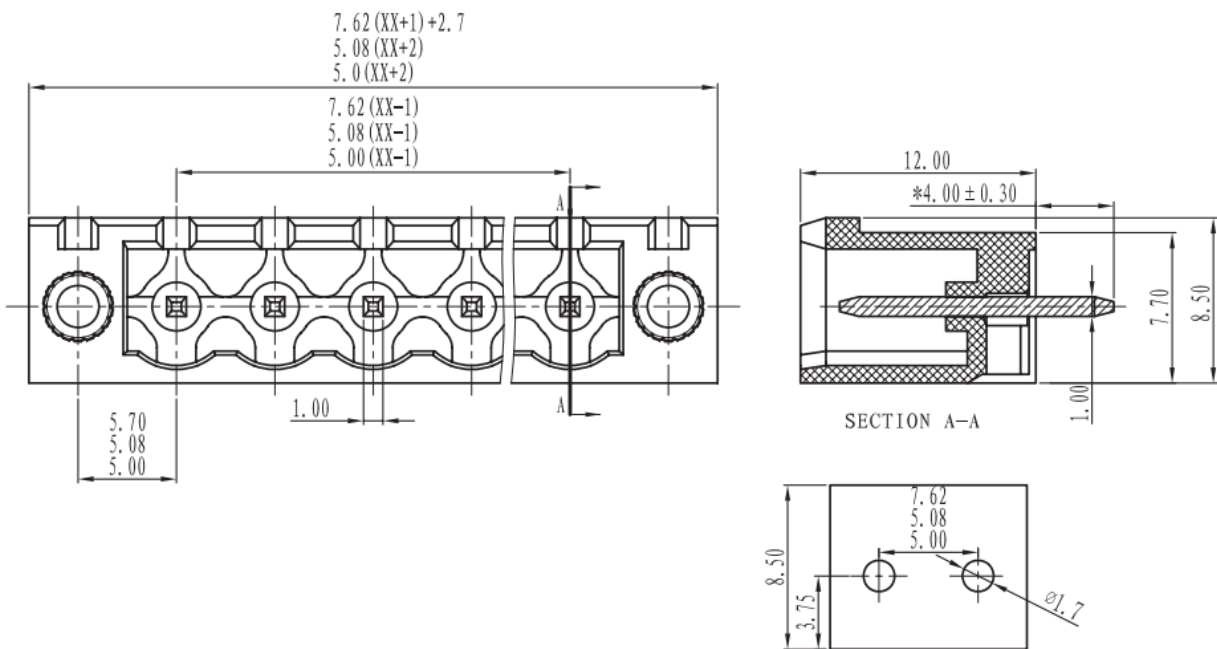



Specifications

Electrical

Standard: UL IEC
 Rated voltage: 300V 320V
 Rated current: 15A 20A
 Contact resistance: 20mΩ
 Withstanding voltage: AC2000V/1Min
 Insulation resistance: 500MΩ/DC500V

Mechanical

Temp.Range: -40° C~+105° C
 MAX Soldering: +250° C, for 5 Sec

Dimensions

Pitch: 5.00mm, 5.08mm, 7.62mm
 Poles: 2P-24P

Material

Housing: PA66, UL94V-0
 Pin header: Brass, Tin plated
 Nut: M2.5 Brass

Tolerances Except As Noted

	linear dimension					fillet	chamfer		∠ short angle sid				≡	—	□	//	⊥
	to	over	over	over	over		to	over	to	over	over	over					
variable range	to 6	over 6 to 30	over 30 to 120	over 120 to 480	over 480 to	all	to 6	over 6 to	to 10	over 10 to 50	over 50 to 120	over 120 to	all	to 5	over 5 to 30	over 30 to 120	over 120 to
tolerance	±0.1	±0.2	±0.3	±0.5	±0.9	±0.2	±0.5	±1	1'	30'	20'	10'	0.5	0.025	0.06	0.12	0.4