

Datasheet

DC Axial Fan

RS Stock number 703-3451

Dimensions: (mm)

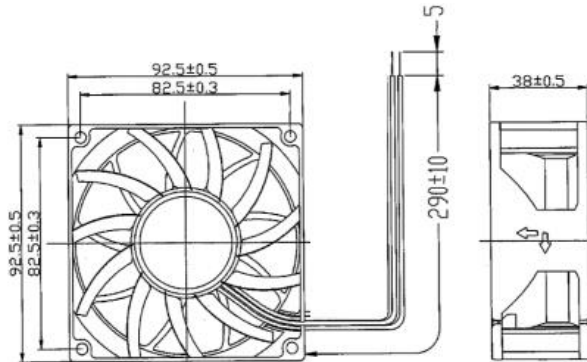

Specification

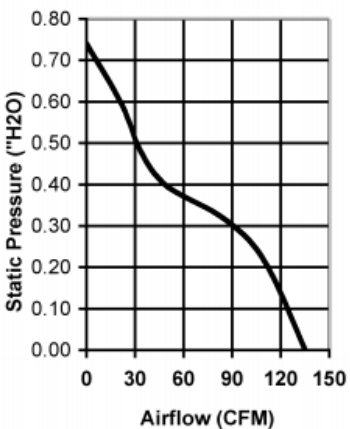
Frame & Impeller	PBT, UL94V-O plastic	Available Options: Tachometer (FG) Alarm PWM	
Connection	2x Lead wires, 290mm, UL1061, AWG 26		
Motor	Brushless DC, auto restart, polarity protected.		
Bearing System	Dual ball bearing		
Insulation Resistance	Min. 10M at 500VDC		
Dielectric Strength	1 minute at 500VAC / 1 second, max leakage 500 microamp		
Temperature Range	-10C ~ +70C		
Storage Temperature	-40C ~ +80C		
Life Expectancy	110,000 hours (40C)		

RS Order number	7033451	7033454	7033458
Model Number	OD9238-12HB-VXC	OD9238-24HB-VXC	OD9238-48HB-VXC
Part Number	195141001	195241001	195441001
Nominal Voltage	12 VDC	24 VDC	48 VDC
Nominal Current	1.33 A (2.0 A max.)	0.65 A (0.95 A max.)	0.35 A (0.45 A max.)
Rated Power	24 W	23 W	22 W
Rated Speed (RPM)	5400	5400	5400
Airflow (CFM)	135	135	135
Noise Level (dB)	58	58	58
Max. Static Pressure	0.74" H ₂ O	0.74" H ₂ O	0.74" H ₂ O