

Part no. : 7634

**Receptacle**

switched, with mechanical DUO-interlock; can be padlocked

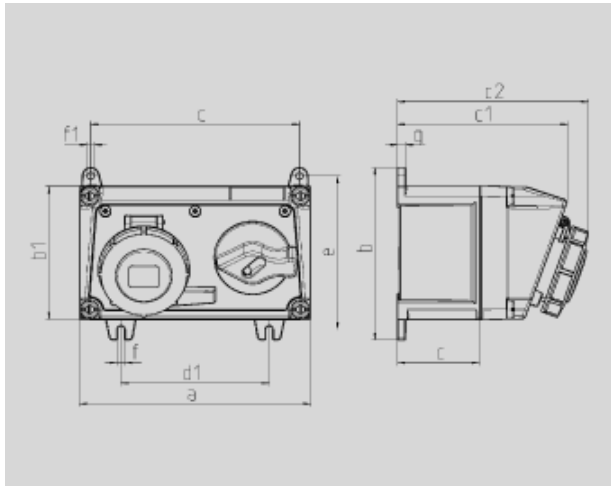

Drawing 1 MB 551	Amp. Poles	16			32		
		3	4	5	3	4	5
Dim. in mm	a	225	225	225	225	225	225
	b	168	168	168	168	168	168
	b1	130	130	130	130	130	130
	c	80	80	80	80	80	80
	c1	166	166	166	166	166	166
	c2	182	185	186	197	197	198
	d	204	204	204	204	204	204
	d1	145	145	145	145	145	145
	e	150	150	150	150	150	150
	f	7	7	7	7	7	7
	f1	Ø7	Ø7	Ø7	Ø7	Ø7	Ø7
	g	8	8	8	8	8	8

 Article-group : **1101**

voltages : 400V

rated current : 32A







pole : 4 pole

IP protection types : 67

position of ground contact : 6h

weight : 1622

**PART NUMBERS**

	V	<b>110V</b>	<b>230V</b>	<b>400V</b>	<b>500V</b>	<b>&gt;50-500V</b>	
	Hz	50,60	50,60	50,60	50,60	100-300	300-500
	colour						
	amp.						
<b>16 A</b>	3	<b>7620</b>	7621				
	4		7623	7624	7625		
	5			7626			
<b>32 A</b>	3	7628	7629				
	4		7633	<b>7634</b>	7635		
	5			7636			