

**Ordering number C13236_SANDRA-12-S**

Family	Sandra	FWHM	10 degrees
Type	Lens array	Efficiency	91 %
LED	Oslon SSL 80	cd/lm	18.500
Color	Clear	Gerber File	Available
Diameter	67 mm		
Height	11.1 mm		
Style	Round		
Optic Material	PMMA		
Holder Material	-		
Fastening	Pin, glue		
Status	Ready		

Ordering number C11814_SANDRA-12-M

Family	Sandra	FWHM	28 degrees
Type	Lens array	Efficiency	90 %
LED	Oslon SSL 80	cd/lm	2.700
Color	Clear	Gerber File	Available
Diameter	67 mm		
Height	11.1 mm		
Style	Round		
Optic Material	PMMA		
Holder Material	-		
Fastening	Pin, glue		
Status	Ready		

Ordering number C11700_SANDRA-12-W

Family	Sandra	FWHM	30 degrees
Type	Lens array	Efficiency	90 %
LED	Oslon SSL 80	cd/lm	2.600
Color	Clear	Gerber File	Available
Diameter	67 mm		
Height	11.1 mm		
Style	Round		
Optic Material	PMMA		
Holder Material	-		
Fastening	Pin, glue		
Status	Ready		

NOTE: The typical divergence will be changed by different color, chip size and chip position tolerance. The typical total divergence is the full angle measured where the luminous intensity is half of the peak value.



PRODUCT DATASHEET

Sandra series

last update 28/3/2013



GENERAL INFORMATION

- Product series especially designed & optimized for Oslon SSL 80 series of LEDs.
- Special care taken to make light distribution as uniform as possible.
- Lens material optical grade PMMA with high UV and temperature resistance. Allows use of high current and temperature conditions.

Please find more information about used material from below:

http://ledil.fi/sites/default/files/Documents/Technical/Material/PMMA%20N%20UL94_Yellow%20Card.pdf

<http://ledil.fi/sites/default/files/Documents/Technical/Material/PMMA%20N%20PLEXIGLAS-Datasheet.pdf>

Relative intensity of C13236_SANDRA-12-S-OSL80

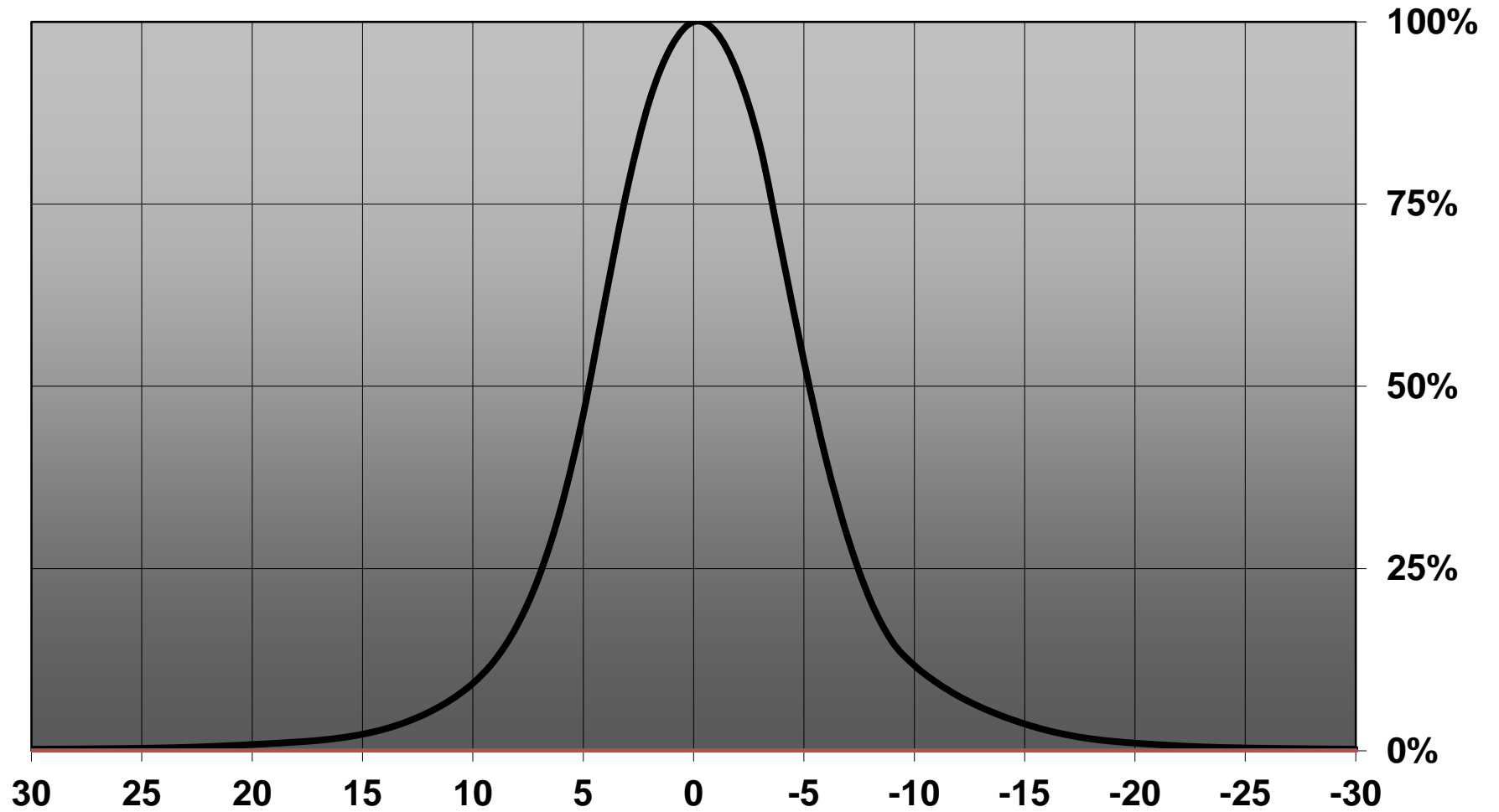

D

C

B

A

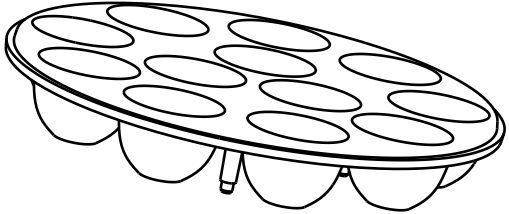

Isometric view
Scale: 1:1

4

4

3

3

2

2

1

1

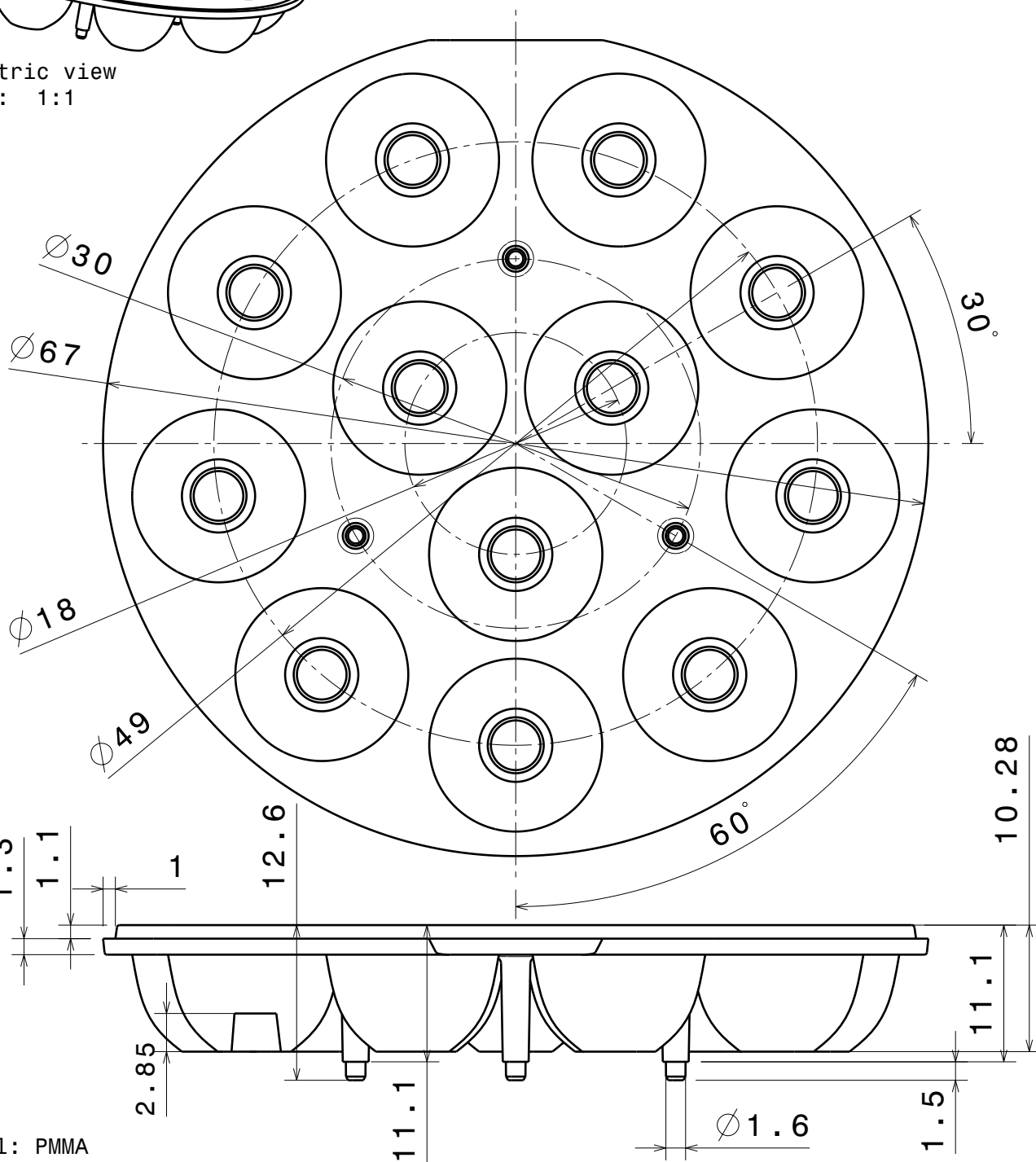

Material: PMMA

This drawing is our property.
It can't be reproduced
or communicated without
our written agreement.



Ledil Oy
Salorankatu 10
FIN-24100 SALO
Finland

DRAWING TITLE
Datasheet Sandra-12 series lens

DRAWN BY
ah
DATE
31.12.2012

CHECKED BY
DATE
SIZE
A4

DRAWING NUMBER
-
REV
1

DESIGNED BY
hh
DATE
27.08.2010

SCALE
2:1
WEIGHT (g)
SHEET
1/1

D

A

Luminaire: Ledil Oy C11814_SANDRA-12-M (Osram Oslon 80deg 968lm @ 250mA) Efficiency=90%
Lamps: 1 x Osram Oslon 80deg 968lm @ 250mA

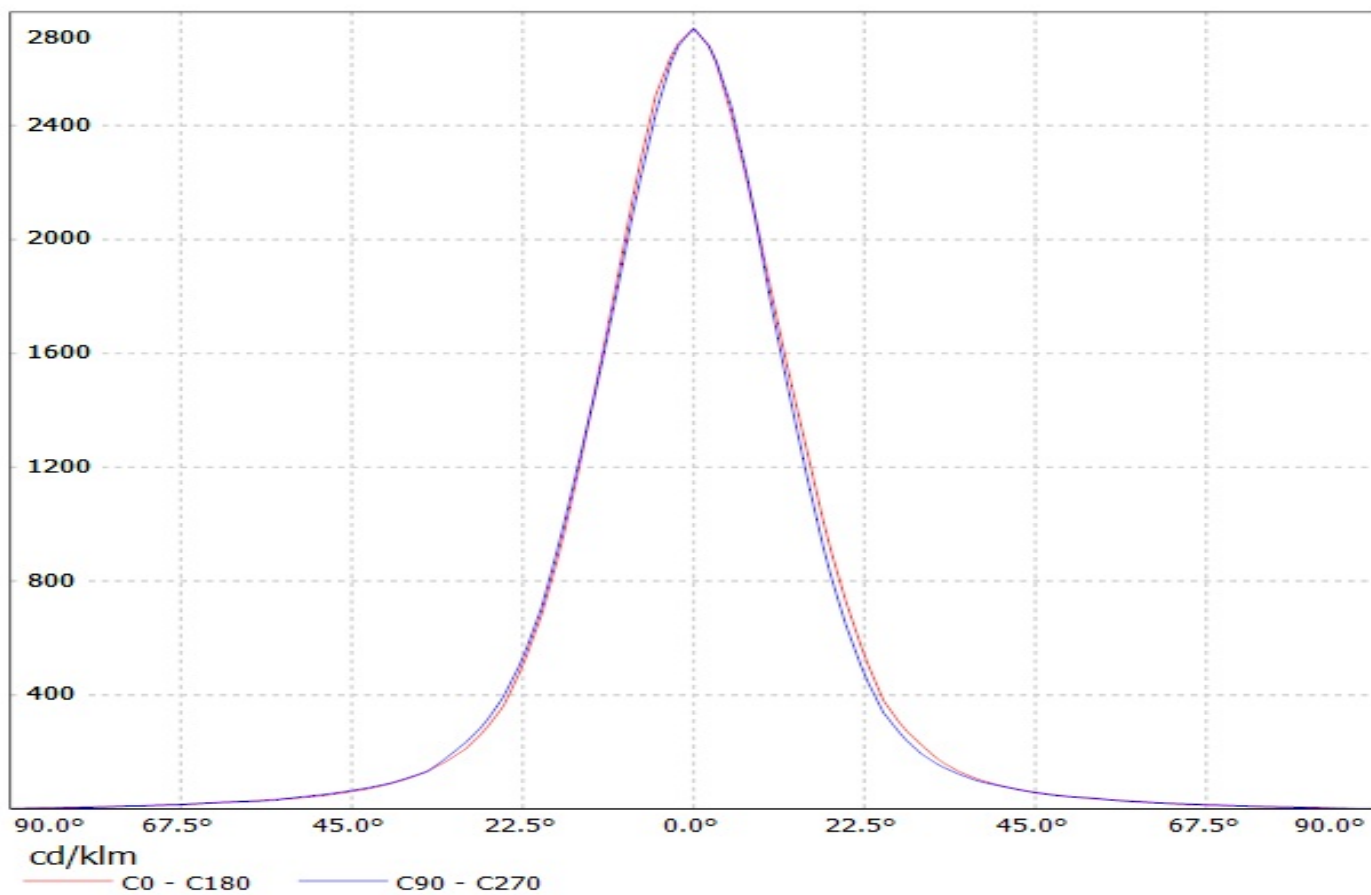

Luminaire: Ledil Oy C11700_SANDRA-12-W (Osram Oslon 80deg 968lm @ 250mA) Efficiency=90%
Lamps: 1 x Osram Oslon 80deg 968lm @ 250mA

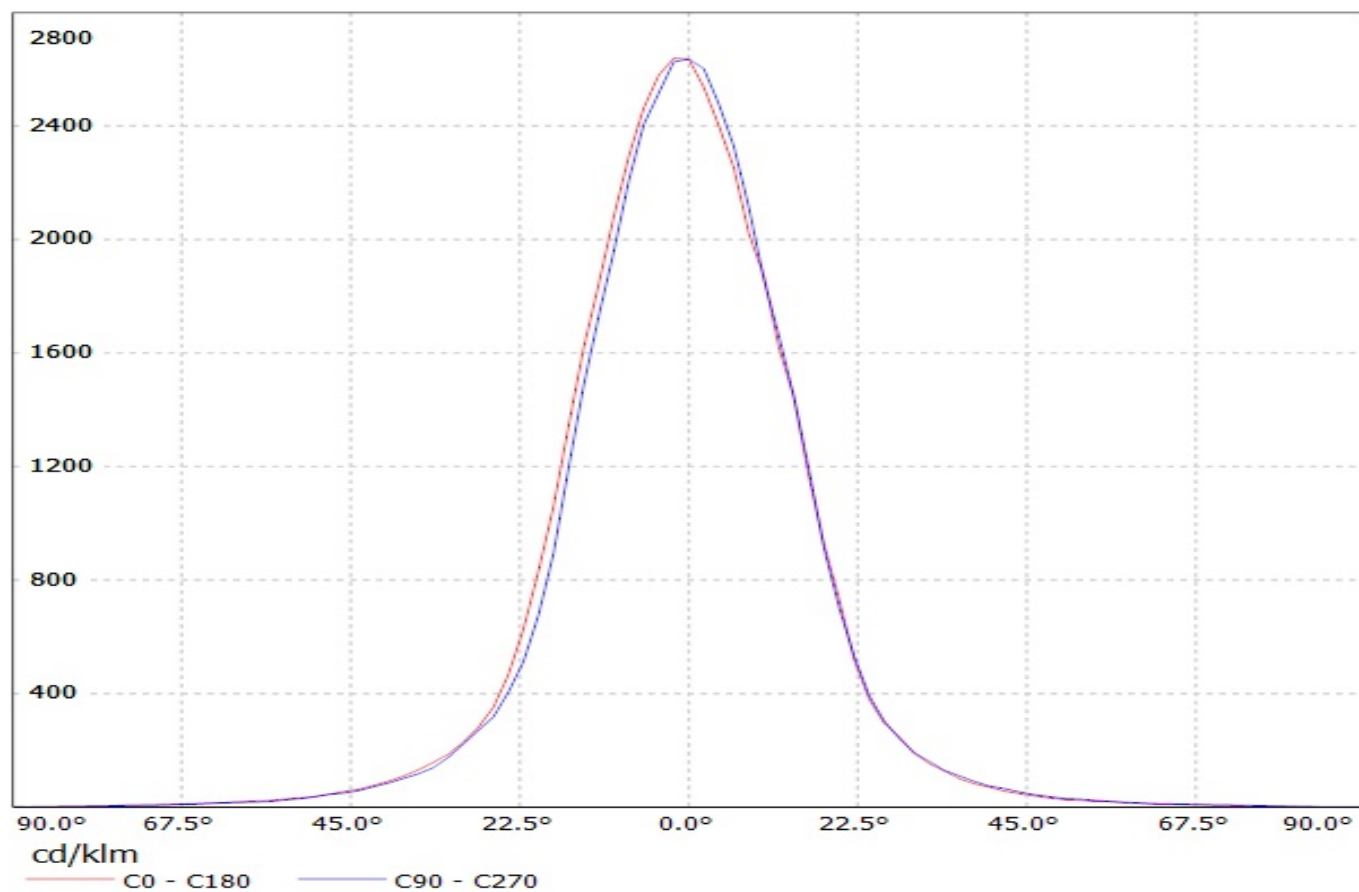

Luminaire: Ledil Oy C11814_SANDRA-12-M (Osram Oslon 80deg 968lm @ 250mA) Efficiency=90%
Lamps: 1 x Osram Oslon 80deg 968lm @ 250mA

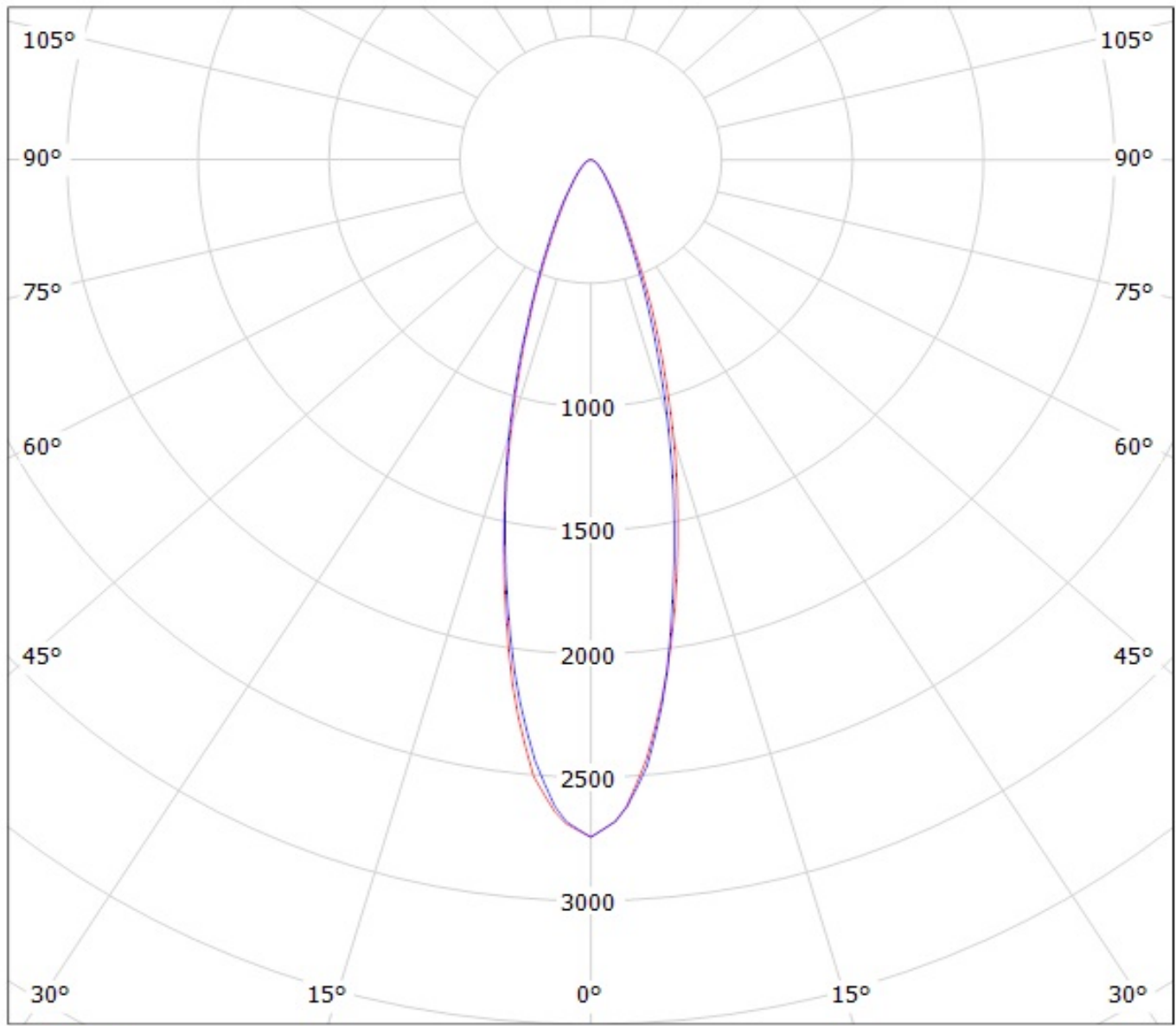

cd/klm

— C0 - C180

— C90 - C270

Luminaire: Ledil Oy C11700_SANDRA-12-W (Osram Oslon 80deg 968lm @ 250mA) Efficiency=90%
Lamps: 1 x Osram Oslon 80deg 968lm @ 250mA

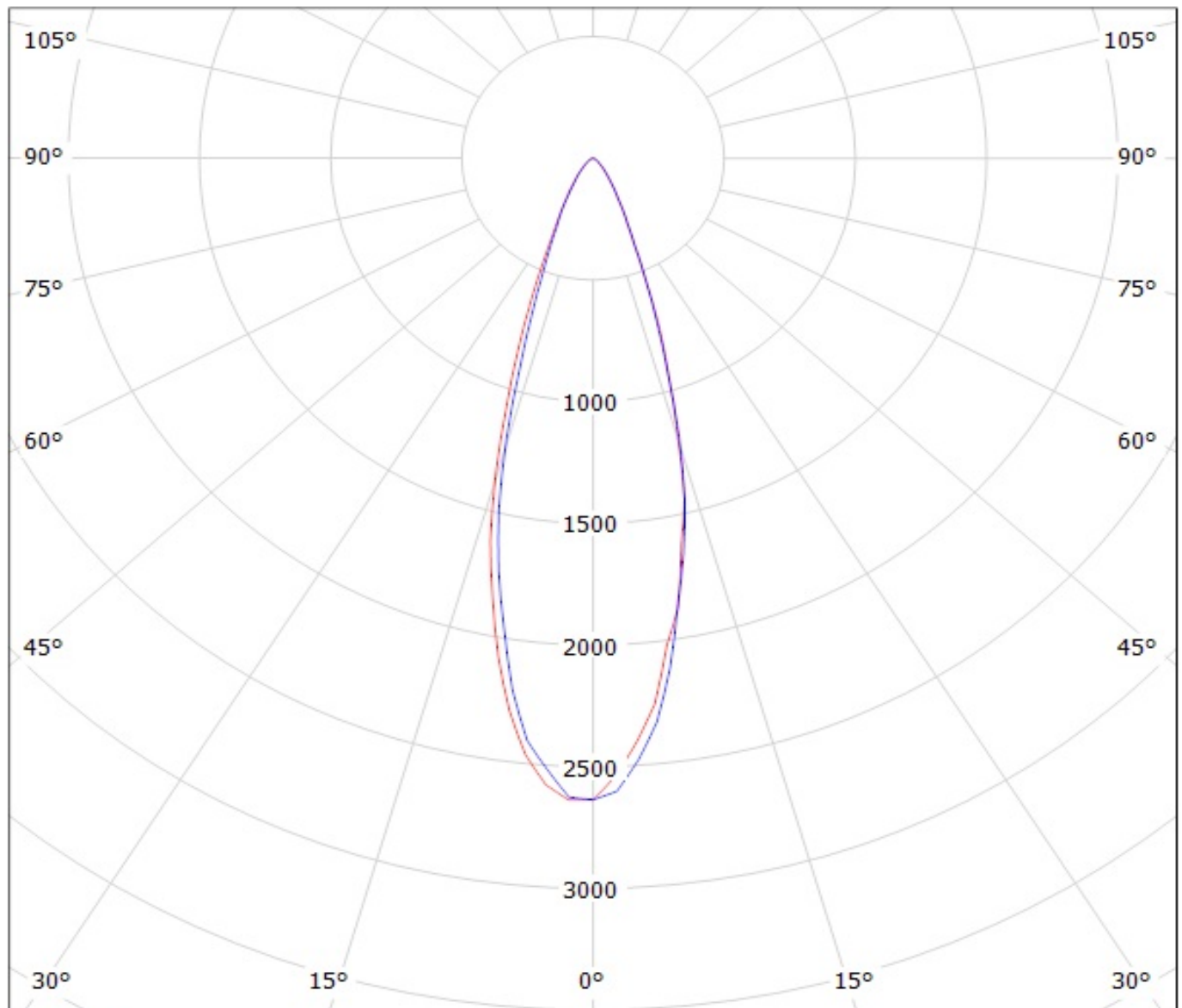

cd/klm

— C0 - C180

— C90 - C270