



WL100L-F2231

W100 Laser

PRODUCT PORTFOLIO

SICK
Sensor Intelligence.



Illustration may differ



Ordering information

Type	Part no.
WL100L-F2231	6030710

Included in delivery: P250F (1), BEF-W100-A (1)

Other models and accessories → www.sick.com/W100_Laser

Detailed technical data

Features

Sensor/ detection principle	Photoelectric retro-reflective sensor, Dual lens
Dimensions (W x H x D)	11 mm x 31 mm x 20 mm
Housing design (light emission)	Rectangular
Sensing range max.	0.08 m ... 12 m ¹⁾
Sensing range	0.08 m ... 10 m ¹⁾
Type of light	Visible red light
Light source	Laser ²⁾
Light spot size (distance)	Ø 12 mm (10 m)
Wave length	650 nm
Laser class	1
Adjustment	Potentiometer, 270°
Special applications	Detecting small objects, Detection of objects moving at high speeds

¹⁾ Reflector P250F.

²⁾ Average service life: 50,000 h at T_U = +25 °C.

Mechanics/electronics

Supply voltage	10 V DC ... 30 V DC ¹⁾
Ripple	± 10 % ²⁾

¹⁾ Limit values when operated in short-circuit protected network: max. 8 A.

²⁾ May not exceed or fall below U_v tolerances.

³⁾ Without load.

⁴⁾ Signal transit time with resistive load.

⁵⁾ With light/dark ratio 1:1.

⁶⁾ A = V_S connections reverse-polarity protected.

⁷⁾ B = inputs and output reverse-polarity protected.

⁸⁾ D = outputs overcurrent and short-circuit protected.

Power consumption	≤ 30 mA ³⁾
Switching output	PNP
Switching mode	Light/dark switching
Switching mode selector	Selectable via light/dark rotary switch
Signal voltage PNP HIGH/LOW	U _V - 1,8 V / ca. 0 V
Output current I_{max.}	≤ 100 mA
Response time	< 0,25 ms ⁴⁾
Switching frequency	± 2,000 Hz ⁵⁾
Connection type	Male connector M8, 4-pin
Circuit protection	A ⁶⁾ B ⁷⁾ D ⁸⁾
Weight	10 g
Polarisation filter	✓
Housing material	Plastic, ABS/PC
Optics material	Plastic, PMMA
Enclosure rating	IP65
Items supplied	Stainless steel mounting bracket (1.4301/304) BEF-W100-A, Reflector P250F
Ambient operating temperature	-10 °C ... +50 °C
Ambient storage temperature	-40 °C ... +70 °C

1) Limit values when operated in short-circuit protected network: max. 8 A.

2) May not exceed or fall below U_V tolerances.

3) Without load.

4) Signal transit time with resistive load.

5) With light/dark ratio 1:1.

6) A = V_S connections reverse-polarity protected.

7) B = inputs and output reverse-polarity protected.

8) D = outputs overcurrent and short-circuit protected.

Classifications

ECl@ss 5.0	27270902
ECl@ss 5.1.4	27270902
ECl@ss 6.0	27270902
ECl@ss 6.2	27270902
ECl@ss 7.0	27270902
ECl@ss 8.0	27270902
ECl@ss 8.1	27270902
ECl@ss 9.0	27270902
ETIM 5.0	EC002717
ETIM 6.0	EC002717
UNSPSC 16.0901	39121528

Adjustments possible

WT100L, WL100L

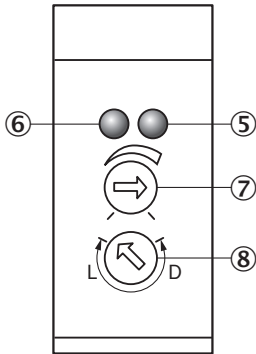

- ⑤ Orange LED indicator : switching output active
- ⑥ LED indicator green: power on
- ⑦ Sensing range (WT) / sensitivity (WL) adjustment: potentiometer, 270°
- ⑧ Light/ dark rotary switch: L = light switching, D = dark switching

Connection diagram

cd-066

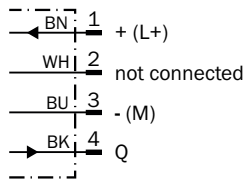

Characteristic curve

WL100L

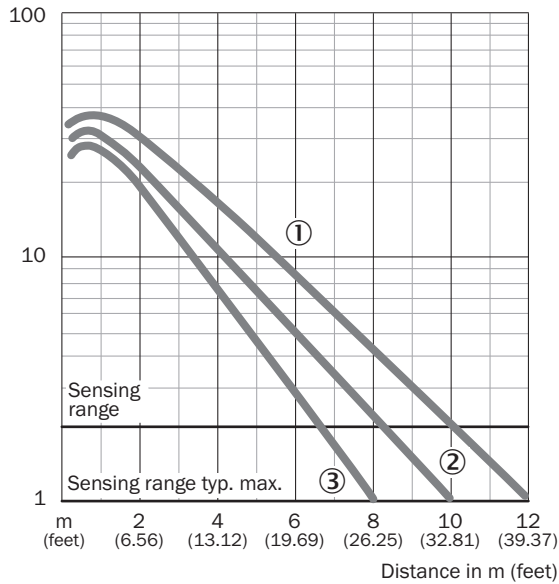

- ① Reflector P250F
- ② Reflector PL20F
- ③ PL10F reflector

Light spot size

WL100L

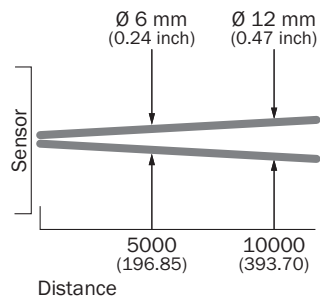

All dimensions in mm (feet)

Sensing range diagram

WL100L

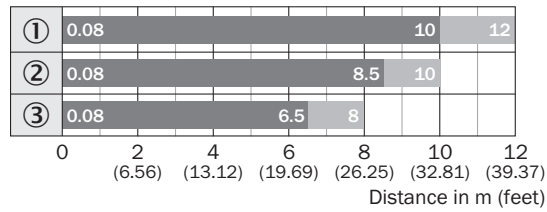

- Sensing range
- Sensing range max.
- ① Reflector P250F
- ② Reflector PL20F
- ③ PL10F reflector

Dimensional drawing (Dimensions in mm (inch))

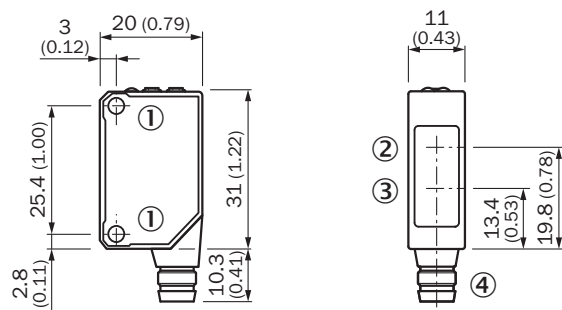

WT100L, WL100L





- ① Threaded mounting hole M3
- ② Center of optical axis, receiver
- ③ Center of optical axis, sender
- ④ Connection

Recommended accessories

Other models and accessories → www.sick.com/W100_Laser

	Brief description	Type	Part no.
Universal bar clamp systems			
	Plate N08 for universal clamp bracket, Zinc plated steel (sheet), Zinc die cast (clamping bracket), Universal clamp (5322626), mounting hardware	BEF-KHS-N08	2051607
Device protection (mechanical)			
	Safety bracket for floor mounting, Stainless steel 1.4571, mounting hardware included	BEF-SW-W4S	2051497

	Brief description	Type	Part no.
Mounting brackets and plates			
	Mounting bracket for wall mounting, stainless steel, mounting hardware included	BEF-W100-A	5311520
	Mounting bracket for floor mounting, steel, zinc coated, mounting hardware included	BEF-W100-B	5311521
Plug connectors and cables			
	Head A: female connector, M8, 4-pin, straight, A-coded Head B: Flying leads Cable: Sensor/actuator cable, PVC, unshielded, 2 m	YF8U14-020VA3XLEAX	2095888
	Head A: female connector, M8, 4-pin, straight, A-coded Head B: Flying leads Cable: Sensor/actuator cable, PVC, unshielded, 5 m	YF8U14-050VA3XLEAX	2095889
	Head A: female connector, M8, 4-pin, angled, A-coded Head B: Flying leads Cable: Sensor/actuator cable, PVC, unshielded, 2 m	YG8U14-020VA3XLEAX	2095962
	Head A: female connector, M8, 4-pin, angled, A-coded Head B: Flying leads Cable: Sensor/actuator cable, PVC, unshielded, 5 m	YG8U14-050VA3XLEAX	2095963
	Head A: female connector, M8, 4-pin, straight Head B: - Cable: unshielded	DOS-0804-G	6009974
	Head A: female connector, M8, 4-pin, angled Head B: - Cable: unshielded	DOS-0804-W	6009975
	Head A: male connector, M8, 4-pin, straight Head B: - Cable: unshielded	STE-0804-G	6037323
Reflectors			
	Rectangular, screw connection, 80 mm x 80 mm, PMMA/ABS, Screw-on, 2 hole mounting	PL80A	1003865
	Fine triple reflector, screw connection, suitable for laser sensors, 47 mm x 47 mm, PMMA/ABS, Screw-on, 2 hole mounting	P250F	5308843
	Fine triple, self-adhesive, suitable for laser sensors, Ø 23 mm, PMMA/ABS, self-adhesive	P25F-1	5319385
	Reflector with microprismatic reflex tape REF-AC1000, suitable for laser sensors, see alignment note, 23 mm x 23 mm, PMMA/ABS, Screw-on, 2 hole mounting	P41F	5315128
	Fine triple reflector, screw connection, suitable for laser sensors, 18 mm x 18 mm, PMMA/ABS, Screw-on, 2 hole mounting	PL10F	5311210
	Fine triple reflector, screw connection, suitable for laser sensors, 38 mm x 16 mm, PMMA/ABS, Screw-on, 2 hole mounting	PL20F	5308844
	Fine triple reflector, screw connection, suitable for laser sensors, 56 mm x 28 mm, PMMA/ABS, Screw-on, 2 hole mounting	PL30F	5326523

	Brief description	Type	Part no.
	Fine triple reflector, screw connection, suitable for laser sensors, 76 mm x 45 mm, PM-MA/ABS, Screw-on, 2 hole mounting	PL81-1F	5325060
	Suitable for laser sensors, self-adhesive, cut, see alignment note, 56.3 mm x 56.3 mm, self-adhesive	REF-AC1000-56	4063030

SICK AT A GLANCE

SICK is one of the leading manufacturers of intelligent sensors and sensor solutions for industrial applications. A unique range of products and services creates the perfect basis for controlling processes securely and efficiently, protecting individuals from accidents and preventing damage to the environment.

We have extensive experience in a wide range of industries and understand their processes and requirements. With intelligent sensors, we can deliver exactly what our customers need. In application centers in Europe, Asia and North America, system solutions are tested and optimized in accordance with customer specifications. All this makes us a reliable supplier and development partner.

Comprehensive services complete our offering: SICK LifeTime Services provide support throughout the machine life cycle and ensure safety and productivity.

For us, that is “Sensor Intelligence.”

WORLDWIDE PRESENCE:

Contacts and other locations –www.sick.com