

13 12 11 10 9 8 7 6 5 4 3 2 1

J I H G F E D C B A

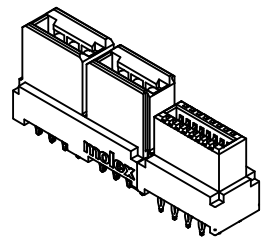

MATERIAL # 46114-4161 SHOWN

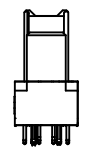
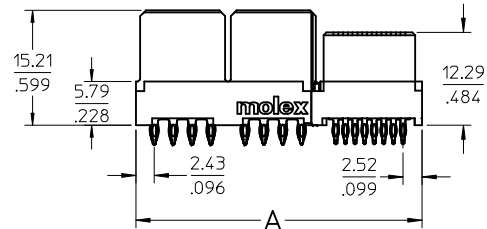
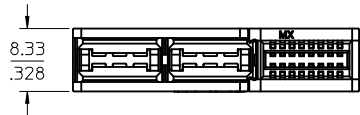
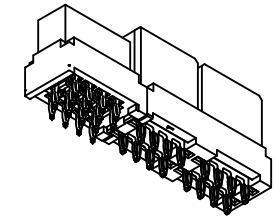

NO OF SIGNALS	MATERIAL NUMBER	COMPLIANT PIN PLATING	DIM A	DIM B	DIM C
12	46114-4121	TIN	35.34/1.391	35.84/1.411	2.69/106
	46114-5121	TIN-LEAD			
16	46114-4161	TIN	37.88/1.491	38.38/1.511	
	46114-5161	TIN-LEAD			
20	46114-4201	TIN	40.42/1.591	40.92/1.611	
	46114-5201	TIN-LEAD			
24	46114-4241	TIN	42.96/1.691	43.46/1.711	
	46114-5241	TIN-LEAD			
28	46114-4281	TIN	45.50/1.791	46.00/1.811	
	46114-5281	TIN-LEAD			
32	46114-4321	TIN	48.04/1.891	48.54/1.911	
	46114-5321	TIN-LEAD			
36	46114-4361	TIN	50.58/1.991	51.08/2.011	
	46114-5361	TIN-LEAD			
40	46114-4401	TIN	53.12/2.091	53.62/2.111	
	46114-5401	TIN-LEAD			

SEE SHT 1 EC NO: UCP2010-1199 DRWN:MKARADIMAS 2009/11/30 CHKD: JCOMERC I 2009/12/03 APPR: JCOMERC I 2009/12/08 REV: C1	QUALITY SYMBOLS	GENERAL TOLERANCES (UNLESS SPECIFIED)	DIMENSION STYLE MM/IN	SCALE 2:1	DESIGN UNITS METRIC	THIRD ANGLE PROJECTION
		4 PLACES ± --- ± ---	DRAWN BY MKARADIMAS	DATE 07/18/07	TITLE LPH VERTICAL RECEPTACLE ASSEMBLY 4 CIRCUIT PWR CONNECTOR, PRESS FIT	
		3 PLACES ± --- ± .010	CHECKED BY APATEL	DATE 07/20/07	MOLEX MOLEX INCORPORATED	
		2 PLACES ± 0.25 ± ---	APPROVED BY JCOMERC I	DATE 2009/12/03	DOCUMENT NO. SD-46114-400	
		1 PLACE ± --- ± ---	ANGULAR ± 1/2°	SEE CHART		SHEET NO. 2 OF 3
DRAFT WHERE APPLICABLE MUST REMAIN WITHIN DIMENSIONS		THIS DRAWING CONTAINS INFORMATION THAT IS PROPRIETARY TO MOLEX INCORPORATED AND SHOULD NOT BE USED WITHOUT WRITTEN PERMISSION				

NO OF SIGNAL	DIM. D
12	8.00/.315
16	10.54/.415
20	13.08/.515
24	15.62/.615
28	18.16/.715
32	20.70/.815
36	23.24/.915
40	25.78/1.015

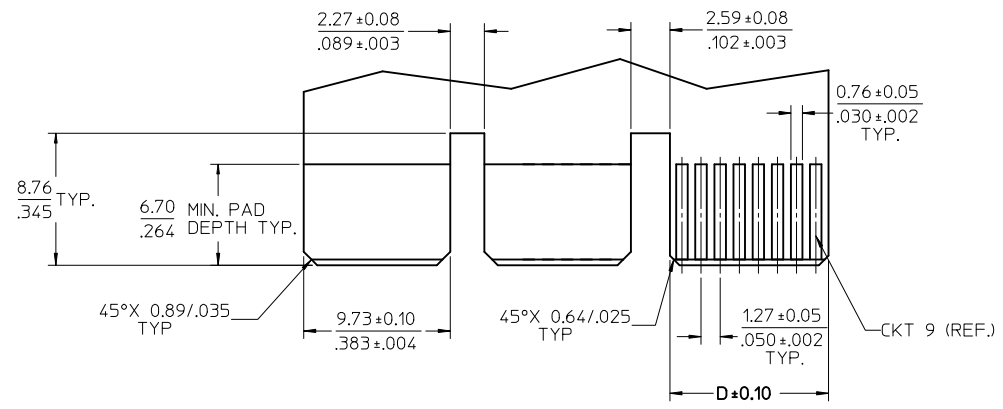
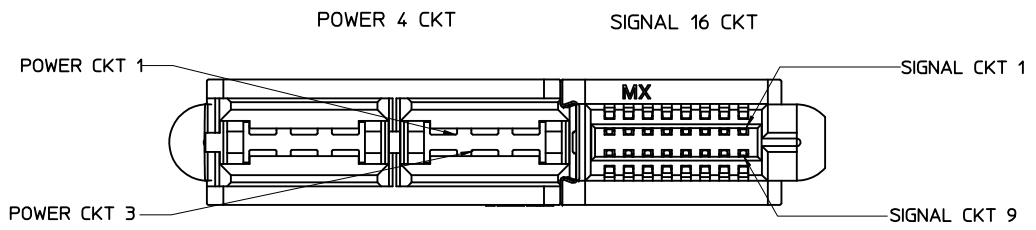

RECOMMENDED EDGE CARD LAYOUT
 EDGE CARD THICKNESS: 157/.062
 PLATING: GOLD 30 μ INCHES MIN.
 OVER 150 μ INCHES NICKEL.

45°X 0.38/.015 TYP

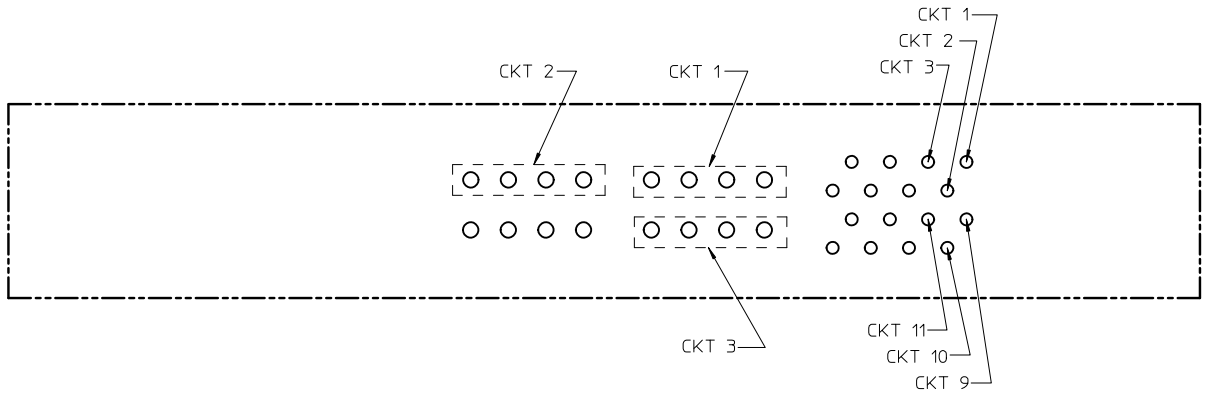

PCB LAYOUT: COMPONENT SIDE
 SEE SHT 1 FOR DIMENSIONS.

SEE SHT 1 IEC NO: UCP2010-1199 DRWN:MKARADIMAS 2009/11/30 CHKD: JCOMERC I 2009/12/03 APPR: JCOMERC I 2009/12/08	QUALITY SYMBOLS	GENERAL TOLERANCES (UNLESS SPECIFIED)		DIMENSION STYLE MM/IN		SCALE 1:1	DESIGN UNITS METRIC	THIRD ANGLE PROJECTION	
		mm	INCH	DRAWN BY MKARADIMAS	DATE 07/18/07	TITLE LPH VERTICAL RECEPTACLE ASSEMBLY 4 CIRCUIT PWR CONNECTOR, PRESS FIT			
		4 PLACES ±---	±---	CHECKED BY APATEL	DATE 07/20/07	APPROVED BY JCOMERC I			
		3 PLACES ±---	±.010	DATE 2009/12/03	DATE 2009/12/03				
	2 PLACES ±0.25	±---	MATERIAL NO.		DOCUMENT NO.		SHEET NO.		
	1 PLACE ±---	±---	ANGULAR ±1/2°		SD-46114-400		3 OF 3		
		DRAFT WHERE APPLICABLE MUST REMAIN WITHIN DIMENSIONS		SEE CHART		THIS DRAWING CONTAINS INFORMATION THAT IS PROPRIETARY TO MOLEX INCORPORATED AND SHOULD NOT BE USED WITHOUT WRITTEN PERMISSION			