

Mini Card Universal Development Kit

Quick Start Guide

Preface

Limitation of liability

The information in this manual is subject to change without notice and does not represent a commitment on the part of Sierra Wireless. SIERRA WIRELESS AND ITS AFFILIATES SPECIFICALLY DISCLAIM LIABILITY FOR ANY AND ALL DIRECT, INDIRECT, SPECIAL, GENERAL, INCIDENTAL, CONSEQUENTIAL, PUNITIVE OR EXEMPLARY DAMAGES INCLUDING, BUT NOT LIMITED TO, LOSS OF PROFITS OR REVENUE OR ANTICIPATED PROFITS OR REVENUE ARISING OUT OF THE USE OR INABILITY TO USE ANY SIERRA WIRELESS PRODUCT, EVEN IF SIERRA WIRELESS AND/OR ITS AFFILIATES HAS BEEN ADVISED OF THE POSSIBILITY OF SUCH DAMAGES OR THEY ARE FORESEEABLE OR FOR CLAIMS BY ANY THIRD PARTY.

Notwithstanding the foregoing, in no event shall Sierra Wireless and/or its affiliates aggregate liability arising under or in connection with the Sierra Wireless product, regardless of the number of events, occurrences, or claims giving rise to liability, be in excess of the price paid by the purchaser for the Sierra Wireless product.

Patents

Portions of this product may be covered by some or all of the following US patents:

5,515,013	5,629,960	5,845,216	5,847,553	5,878,234
5,890,057	5,929,815	6,169,884	6,191,741	6,199,168
6,339,405	6,359,591	6,400,336	6,516,204	6,561,851
6,643,501	6,653,979	6,697,030	6,785,830	6,845,249
6,847,830	6,876,697	6,879,585	6,886,049	6,968,171
6,985,757	7,023,878	D442,170	D459,303	

and other patents pending.

This product includes technology licensed from

QUALCOMM®
3G CDMA

Licensed by QUALCOMM Incorporated under one or more of the following United States patents and/or their counterparts in other nations:

4,901,307	5,056,109	5,101,501	5,109,390	5,228,054
5,267,261	5,267,262	5,337,338	5,414,796	5,416,797
5,490,165	5,504,773	5,506,865	5,511,073	5,535,239
5,544,196	5,568,483	5,600,754	5,657,420	5,659,569
5,710,784	5,778,338			

Copyright

©2006 Sierra Wireless. All rights reserved.

Trademarks

“Heart of the Wireless Machine” is a registered trademark of Sierra Wireless. Sierra Wireless, the Sierra Wireless logo, the red wave design, the red-tipped antenna, and Watcher are trademarks of Sierra Wireless.

Windows® is a registered trademark of Microsoft Corporation.

Qualcomm® is a registered trademark of Qualcomm Incorporated.

Other trademarks are the property of the respective owners.

Contact information

Technical Support:	You will have received (by e-mail) instructions on how to access the OEM Customer Support web site. For more details, please contact your account manager, or the Sierra Wireless sales desk (see below).	
Sales Desk:	Phone:	1-604-232-1488
	Hours:	8:00 AM to 5:00 PM Pacific Time
	E-mail:	sales@sierrawireless.com
Post:	Sierra Wireless 13811 Wireless Way Richmond, BC Canada V6V 3A4	
Fax:	1-604-231-1109	
Web:	www.sierrawireless.com	

For up-to-date product descriptions, documentation, application notes, firmware upgrades, troubleshooting tips, and press releases:

www.sierrawireless.com

To obtain the schematics for this device, contact your Sierra Wireless FAE and refer to Item #2500083.

Table of contents

Introduction	5
Required Equipment	5
Setup and installation	6
Hardware setup	6
Insert a USIM card (UMTS modules only)	6
Insert the Mini Card	7
Remove/replace the Mini Card	8
Connect the antenna(s)	8
Connect the power supply and USB cable	10
Configure the module	10
Install/update drivers	12
Install drivers for CDMA modules (MC57xx)	12
Install drivers for UMTS modules (MC87xx)	13
Install Watcher	14
Install Watcher for CDMA modules (MC57xx)	14
Install Watcher for UMTS modules (MC87xx)	15

Introduction







This quick start guide explains how to set up the hardware and software components of Sierra Wireless' Universal Development Kit (UDK) for use with:

- CDMA modules – MC5720, MC5725
- UMTS modules – MC8755/8755V, MC8765/8765V, MC8775

Required Equipment

Table 1 details the items required to begin using the UDK in your development environment. If any items are missing from the UDK, contact your Sierra Wireless representative.

Table 1: Required equipment

Item	Included in UDK	Details
	No	Ask your Sierra Wireless FAE (Field Application Engineer) for downloading instructions. Available for Windows XP Pro (SP2) and higher, and Windows 2000 Pro (SP4) and higher.
	Yes	The kit includes 2 each of: <ul style="list-style-type: none"> • Antenna • Antenna connector • Sample/replacement Molex connector • Connecting wire
	Yes	
	Yes	The Mini Card is inserted into the daughterboard for testing and development.
	Yes	Universal power supply, suitable for both 120 V and 240 V.
	Yes	Standard USB-A to USB-B cable
	No	(UMTS only) You need to supply a USIM with an active UMTS account for use with UMTS Mini Cards.

Setup and installation

To begin using the UDK with your development system, you need to:

Set up the hardware

- [Insert a USIM card \(UMTS modules only\)](#) (page 6)
- [Insert the Mini Card](#) (page 7)
- [Connect the antenna\(s\)](#) (page 8)
- [Connect the power supply and USB cable](#) (page 10)
- [Configure the module](#) (page 10)

Set up the software

- [Install/update drivers](#) (page 12)
- [Install Watcher](#) (page 14)

Hardware setup

Insert a USIM card (UMTS modules only)

To use a UMTS module (MC87xx), you need to install a USIM card (with an active UMTS account).

1. Place the daughterboard face-down – the USIM slot is at the opposite end from the antenna connection.

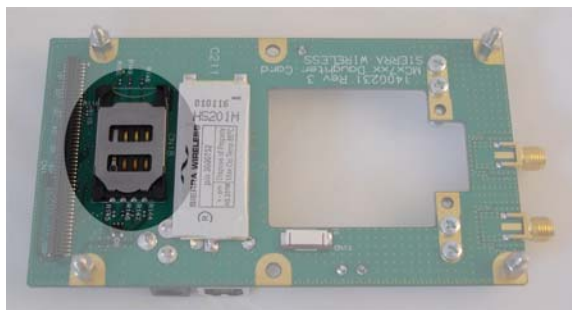

2. Open the USIM casing – the casing latches in place, so you may have to push the tab marked “LIFT” slightly to the side before lifting it.

3. Insert the USIM card with its circuitry facing the daughterboard – line up the notch in the card with the notch in the slot.



4. Close the USIM casing.

Insert the Mini Card

After inserting the USIM card, insert the Mini Card:

1. Place the daughterboard face-up – the Mini Card slot is beside the USB connector.

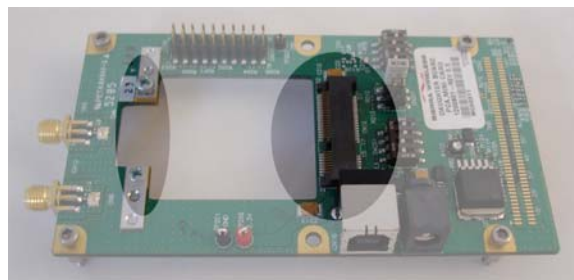

2. Remove the two screws that are located on the metal strips near the antenna end of the board.
3. Hold the Mini Card at the screw holes and slide it into the daughterboard's Mini Card slot at a 45-degree angle.



4. Push and hold the module down when it is firmly seated in the slot and then fasten it using the screws removed in Step 2.



Remove/replace the Mini Card

When you want to remove or replace the Mini Card:

1. Place the daughterboard face-up.
2. Remove the connecting wire(s) from the Mini Card's antennas – use the connector tool, hooking it under the wire connector and pull straight up.



3. Unscrew the Mini Card from the daughterboard.
4. Hold the module at the screw holes and raise it to a 45-degree angle.
5. Pull the module out of the slot.

Connect the antenna(s)

After installing the Mini Card, connect the supplied antenna(s) to the daughterboard (UMTS modules have a single antenna, CDMA modules have a main antenna and a diversity antenna):

1. Place the daughterboard face-up.

2. Screw the silver adapter onto the daughterboard's main antenna connector.



3. Connect the Mini Card's main antenna to the daughterboard's main antenna connector using the gray wire provided – press down lightly on the connector ends (the first few times you use these connectors, they may be quite snug – press straight down on the end to get a secure connection).



4. Connect the antenna to the adapter. (The first few times you attach the antenna, it may be quite snug.)



5. If you are using a CDMA module, repeat Steps 2-4 for the diversity antenna.

Connect the power supply and USB cable

To install the power supply and USB cable:

1. Place the daughterboard face-up.
2. Insert one end of the USB cable into the USB connector (beside the Mini Card) – the other end connects to your development computer (DO NOT connect it yet).
3. Insert the power supply into the daughterboard’s power supply connector (beside the USB connector) – the other end connects to a standard power outlet.

Configure the module

The daughterboard includes several switches and jumpers that you can use to configure the module’s operation, as detailed in Tables 2 through 5.

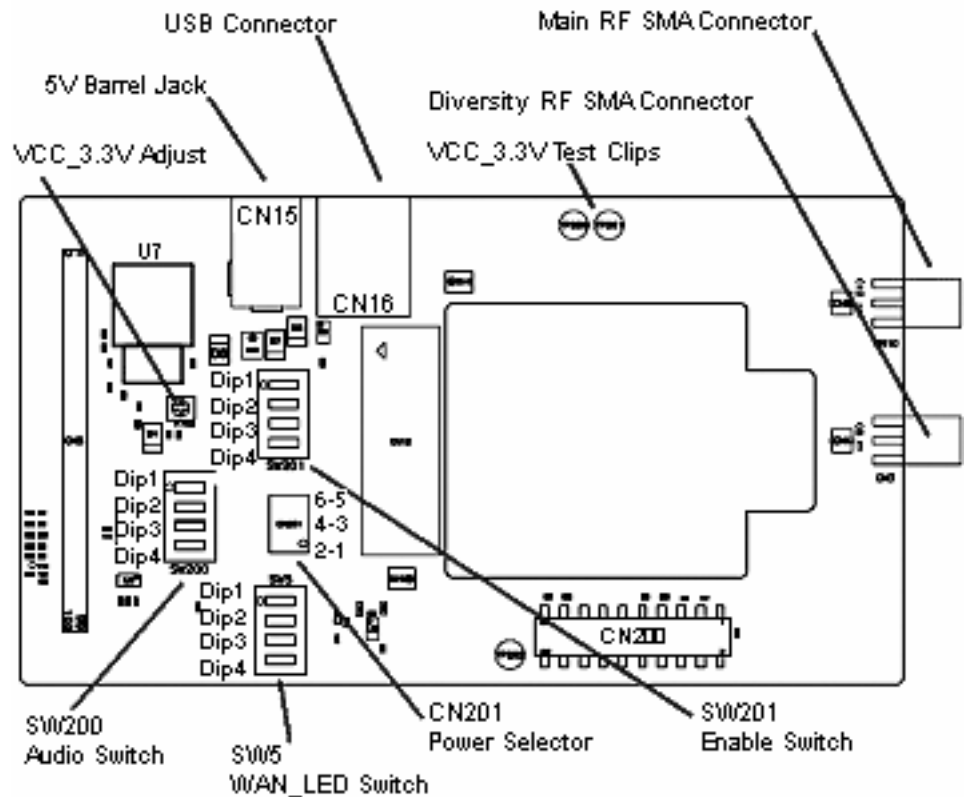

Table 2: SW200 Audio switch (installed on daughterboards used for voice-enabled modules)

Function	Dip1	Dip2	Dip3	Dip4
+20 dB mic path gain	On	Off		
Unity gain mic path gain	Off	On		
Disable mic connection	Off	Off		
Differential mic input			On	Off
Single-ended mic input			Off	On
Disable mic connection			Off	Off

Table 3: SW5 - WAN LED switch

Function	Dip1	Dip2	Dip3	Dip4
OPEN DRAIN LED control	On	Off	On	Off
CMOS LED control	Off	On	Off	On
Disable LED control	Off	Off	Off	Off

Table 4: SW201 - Enable switch

Function	Dip1	Dip2	Dip3	Dip4
Fix VCC_3.3V LDO output to 3.30 V (powered from barrel jack)	On		Always off	
Allow VCC_3.3V LDO output to adjust from 2 V to 5 V via R102 potentiometer	Off			
Enable VCC_3.3V LDO		On		
Disable VCC_3.3V LDO		Off		
Disable Mini Card (asserts W_DISABLE_N)				On
Enable Mini Card (deasserts W_DISABLE_N)				Off

Table 5: CN201 - Power selection switch

Function	Jump 1-2	Jump 3-4	Jump 5-6
Enable onboard LDO to supply VCC_3.3V power from barrel jack	Yes	n/a	
Insert supercapacitor in circuit on VCC_3.3V node (useful for GSM products)			Yes

R102 - VCC_3.3V Adjust

R102 can be used to scale the output of the VCC_3.3V on board regulator in the range of 2.0 V-5.0 V when CN201 pins 1 and 2 are jumpered and SW201 (Dip-1) is off.

Install/update drivers

Contact your Sierra Wireless FAE for instructions on downloading the most recent driver/software installation package for your module. This package contains drivers for Windows 2000 Professional and Windows XP Professional.

Install drivers for CDMA modules (MC57xx)

1. Download the installation package as instructed by your Sierra Wireless FAE.
2. If you have installed earlier versions of the Sierra Wireless drivers, you must remove them before continuing:
 - a. Open the Control Panel (**Start > Settings > Control Panel** or **Start > Control Panel** depending on your operating system and view).
 - b. Double-click **Add or Remove Programs**.
 - c. Select **Sierra Wireless USB MUX Driver package**.
 - d. Click **Remove**. You are prompted to confirm that the package is to be deleted.
 - e. Click **Yes**. The package is deleted and the installed programs list is updated.
 - f. Close the window.
3. Run the installer file (double-click the icon in Windows Explorer, or use **Start > Run** and then browse for the file). The Sierra Wireless USB MUX Driver package Installation window appears.
4. Click **Next**. The License Agreement appears.
5. Read the agreement, select **I accept the terms in the license agreement**, and then click **Next**. The Customer Information section appears.
6. Enter appropriate information (name, organization, installation options) and then click **Next**. The Setup Type window appears.
7. Select **Complete** and then click **Next**. The Ready to Install the Program window appears.
8. Click **Install**. A progress indicator appears, showing the progress of the installation process, and then the Installation Completed window appears.
9. Click **Finish**.
10. Connect your computer to the daughterboard using the USB cable – several Found New Hardware balloons appear above the tool tray as the system detects the Mini Card devices. After the devices are detected, you can see them in the Device Manager in the following categories:

Modems

- Sierra Wireless Modem Device

Network adapters

- Sierra Wireless 1xEV-DO Network Adapter

Ports (COM&LPT)

- Sierra Wireless COM Port Device
- Sierra Wireless COM Port Device

Universal Serial Bus controllers

- Sierra Wireless MC5720 Device

Install drivers for UMTS modules (MC87xx)

1. Download the installation package as instructed by your Sierra Wireless FAE.
2. If you have installed earlier versions of the drivers, you must remove them before loading the new ones:
 - a. Open the Control Panel (**Start > Settings > Control Panel** or **Start > Control Panel**).
 - b. Double-click **System**. The System Properties window appears.
 - c. Click the **Hardware** tab.
 - d. Click **Device Manager**.
 - e. Expand **Universal Serial Bus controllers** to show the installed devices.
 - f. Right-click the **Sierra Wireless MC87xx Device** entry and choose **Uninstall**.
 - g. Click **OK** to confirm that the device is to be uninstalled.
This removes all of the Sierra Wireless drivers listed in Step 4.
3. Locate and run **DriverInstaller.exe** – it is in the Software\DriverInstaller folder. You can use **Start > Run** and then browse for the file, or double-click the program icon in Windows Explorer.
Note: There is no feedback – the program takes only a few moments to run.
4. Connect your computer to the daughterboard using the USB cable – several Found New Hardware balloons appear above the tool tray as the system detects the Mini Card devices. After the devices are detected, you can see them in the Device Manager in the following categories:

Network adapters

- Sierra Wireless HSDPA Network Adapter

Ports (COM&LPT)

- Sierra Wireless AT Command Port (UMTS)
- Sierra Wireless CNS Port (UMTS)
- Sierra Wireless Data Port (UMTS)
- Sierra Wireless DM Port (UMTS)

Universal Serial Bus controllers

- Sierra Wireless MC87xx Device

Install Watcher

Contact your Sierra Wireless FAE for instructions on downloading the correct version of Watcher for your module, or to order the software on CD.

Install Watcher for CDMA modules (MC57xx)

To install Watcher (for Windows 2000 Professional and Windows XP Professional):

1. If you have installed an earlier version of Watcher, you must remove it before continuing:
 - a. Open the Control Panel (**Start > Control Panel** or **Start > Settings > Control Panel**).
 - b. Double-click **Add or Remove Programs**.
 - c. Select **Sierra Wireless EVDO Watcher**.
 - d. Click **Change/Remove**.
2. Download the installation file indicated by your Sierra Wireless FAE – this is a .zip file.
3. Install Watcher – unzip the file and then run **launch.exe**. The 3G Wireless Module screen appears.
4. Click **Notebook Installation**. The screen options change.
5. Click **Notebook Software Installation**. The Watcher installation Welcome window appears.
6. Click **Next**. The License Agreement appears.
7. Read the agreement, select **I accept the terms in the license agreement**, and then click **Next**. The Customer Information section appears.
8. Enter appropriate information (name, organization, installation options) and then click **Next**. The destination folder selection section appears.
9. Use the default folder (or click **Change** to select a different folder), and then click **Next**. The Setup Type section appears.
10. Select **Complete** and then click **Next**. The Ready to Install the Program section appears.
11. Click **Install**. A progress indicator appears, showing the progress of the installation process.
 - a. If you are prompted to retain existing drivers, click **Yes**. (You installed the most recent drivers in the previous procedure.)The Installation Completed section appears.
12. Click **Finish**.
13. On the 3G Wireless Module screen, click **exit**.

Install Watcher for UMTS modules (MC87xx)

To install Watcher (for Windows 2000 Professional and Windows XP Professional):

1. If you have installed an earlier version of Watcher, you must remove it before continuing:
 - a. Open the Control Panel (**Start > Control Panel** or **Start > Settings > Control Panel**).
 - b. Double-click **Add or Remove Programs**.
 - c. Select **Sierra Wireless 3G Watcher**.
 - d. Click **Change/Remove**.
2. Download the installation file indicated by your Sierra Wireless FAE – this is an .msi file.
3. Install Watcher – run the .msi file. The Watcher installation Welcome window appears.
4. Click **Next**. The Select Region section appears.
5. Select the appropriate region and click **Next**. The License Agreement appears.
6. Read the agreement, select **I accept the terms in the license agreement**, and then click **Next**. The destination folder selection section appears.
7. Use the default folder (or click **Change** to select a different folder), and then click **Next**. The Device type section appears.
8. Click **Sierra Wireless HSDPA Embedded MiniCard**. The Setup Type section appears.
9. Select **Complete** and then click **Next**. The Ready to Install the Program section appears.
10. Click **Install**. A progress indicator appears, showing the progress of the installation process, and then the Installation Completed section appears.
11. Click **Finish**.