

S8VM POWER SUPPLIES

The power supplies that alert you!

» New ultra-compact housing

» **Early-warning system**

» Easy installation



For fast and accurate action to minimise machine downtime

Industrial power supplies must meet the same high standards of robustness and reliability as the machines in which they operate. Failures, resulting in interrupted processes and lost production, are expensive and must be corrected as fast as possible to minimise machine downtime. Here's where Omron's new S8VM industrial Switch Mode Power Supply series comes in.

Featuring a new undervoltage alarm with a unique troubleshooting function, S8VM power supplies provide not only a clear indication that a DC output voltage drop has occurred, but also indicate the likely cause – allowing fast, effective corrective action to be taken.

The S8VM series is also designed for direct, easy DIN-rail mounting. And supporting today's trend towards ever-greater downsizing in industrial equipment, the series comes in a new ultra-compact housing that, depending on output power, can be up to 40% smaller than conventional 'compact' power supplies.



Excellent reasons then, for choosing Omron's new S8VM power supplies. Designed by Omron to provide optimum quality management of your industrial processes and ease of maintenance.





Early warning

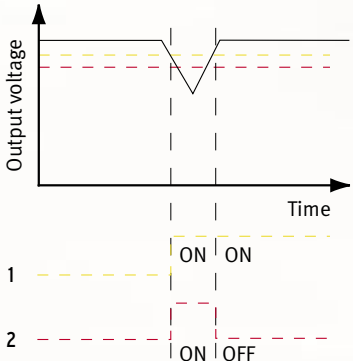

Momentary drop in output voltage
DC LOW1 (Yellow LED) lit
 Due most likely to a fault on the input of the power supply or a transient abnormality in the load.

Gradual drop in output voltage to below 20 V; remaining low
DC LOW2 (Red LED) lit
 Due most likely to degradation in power supply components due to age.

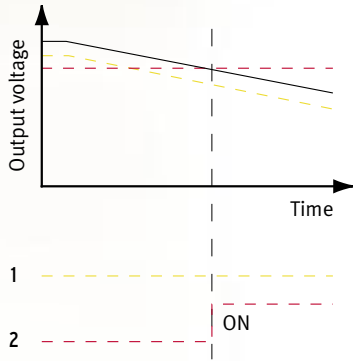
Output voltage remains low following sudden voltage drop
DC LOW1 & 2 (red and yellow LEDs) lit
 Due most likely to a fault such as a short circuit in the load.

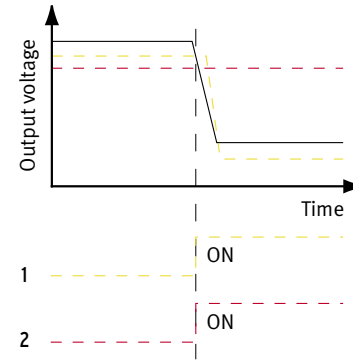

Timely, efficient on-site troubleshooting for optimum quality management

The S8VM series is unique in offering an undervoltage alarm with a diagnostic function to aid on-site troubleshooting. This enables you to go straight to the heart of a problem, whether in the mains supply, the electrical circuit of the cabinet or the power supply itself. The result – fast, effective remedial action with no costly delays!

Featured on all 24 V output power supplies, the S8VM's troubleshooting function lets you determine whether faults

are due to deterioration of the power supply, abnormal input or an abnormality in the electrical circuit of the cabinet by means of 2 LEDs (yellow and red) on the front of the housing.

Early-warning system

In addition to the LED indication, the 24 V models with output powers of 50 W and higher also provide an undervoltage alarm output. This can convey an on/off signal through a wire to, for example, a PLC or HMI to help provide a visible fault warning at a remote location. The signal can also be used to switch on a lamp or cause it to flash continuously.

New ultra-compact housing supports cabinet downsizing

Supporting the trend for ever-greater downsizing in industrial equipment, Omron placed top priority on internal circuit layout to minimise size without compromising thermal performance. The result – a new ultra-slim housing that can be accommodated in virtually any cabinet and in any position within a cabinet. What's more, a standard housing height of 84.5 mm for all power ratings further simplifies cabinet design.

New
ultra-compact
housing



Broad product range meeting your diverse needs

Meeting the diverse demands of industrial users, the single-phase S8VM series is available in a broad range of DC output voltages from 5 V up to 24 V and in powers from 15 W to 150 W. Moreover, the range will be extended to cover even higher powers from 300 W right up to 1500 W in early 2006.

And that's not all. To support industrial manufacturers serving international markets, the series complies with all relevant international safety standards. And reflecting Omron's ongoing commitment to environmental protection, the series already meets RoHS requirements, which set limits on the presence of hazardous substances, such as lead.

Semiconductor wafer production



Semiconductor manufacture demands sophisticated and highly-reliable production machinery to process sensitive wafers and other semiconductor components.

Continuous production processes

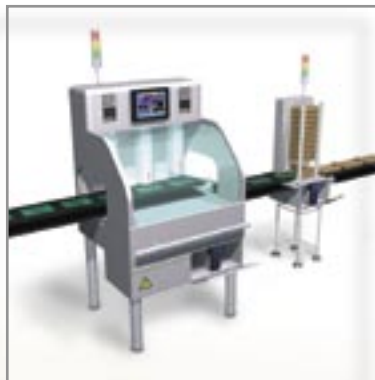

To maintain continuous production processes, any faults in the production equipment must be quickly traced and corrected.

Robotics in the automotive industry



The fiercely-competitive automotive industry relies on robust and highly-reliable robotic production equipment to guarantee minimum downtime.

Switch Mode Power Supply S8VM (15/30/50/100/150-W Models)

Power Supply Featuring OMRON's Unique, New Undervoltage Alarm Function with Compact Body Contributing to Machine Downsizing

- New undervoltage alarm function assists in determining causes of errors (S8VM-□□□24A□/P□ only).
- Broad range of possibilities with 5 capacities and 20 models to choose from.
- RoHS compliant, including lead-free construction.
- Safety standards: UL508/60950-1/1604, CSA C22.2 No. 14/No. 60950-1/No. 213, EN50178, EN60950-1
- Harmonic current emissions: Conforms to EN61000-3-2.
- New, attentive design prevents screws from falling out of terminal block.
- Finger protection prevents electric shock.
- DIN Rail mounting.



Note: 300- to 1,500-W models will be released in 2006.

Note: Refer to *Precautions for Safe Use* on page 19.

Model Number Structure

Model Number Legend

Note: Not all combinations are possible. Please refer to the list of models in *Ordering Information* on page 2.

S8VM- □□□□□□
 1 2 3 4

1. Power Ratings

015: 15 W
030: 30 W
050: 50 W
100: 100 W
150: 150 W

2. Output voltage

05: 5 V
12: 12 V
15: 15 V
24: 24 V

3. Configuration/function

None:	Open-frame type	Standard type
C:	Covered type	Standard type
A:	Covered type	Undervoltage alarm type (Sinking) (See note.)
P:	Covered type	Undervoltage alarm type (Sourcing) (See note.)

4. Configuration

None	Front-mounting type
D	DIN Rail mounting bracket type

Note: 1. The front-mounting type cannot be used as a back-mounting type. For a back-mounting configuration, use a DIN Rail mounting bracket type.

2. The housing and terminal of the connector for the undervoltage alarm output are provided with the S8VM-05024A□/P□, S8VM-10024A□/P□ and S8VM-15024A□/P□.

Ordering Information

Note: S8VM-□□□□□CD and S8VM-□□□□□PD models are standard inventory items, for other items please contact your OMRON representative or distributor.

Configura-tion	Power ratings	Input voltage	Output voltage	Output current	Front-mounting			DIN Rail mounting bracket				
					Standard type	Undervoltage alarm type		Standard type	Undervoltage alarm type			
						Sinking	Sourcing		Sinking	Sourcing		
Open-frame type	15 W	100 to 240 VAC	5 V	3 A	S8VM-01505	---	---	S8VM-01505D	---	---		
			12 V	1.3 A	S8VM-01512	---	---	S8VM-01512D	---	---		
			15 V	1 A	S8VM-01515	---	---	S8VM-01515D	---	---		
			24 V	0.65 A	S8VM-01524	---	---	S8VM-01524D	---	---		
	30 W		5 V	6 A	S8VM-03005	---	---	S8VM-03005D	---	---		
			12 V	2.5 A	S8VM-03012	---	---	S8VM-03012D	---	---		
			15 V	2 A	S8VM-03015	---	---	S8VM-03015D	---	---		
			24 V	1.3 A	S8VM-03024	---	---	S8VM-03024D	---	---		
	50 W		5 V	10 A	S8VM-05005	---	---	S8VM-05005D	---	---		
			12 V	4.3 A	S8VM-05012	---	---	S8VM-05012D	---	---		
			15 V	3.5 A	S8VM-05015	---	---	S8VM-05015D	---	---		
			24 V	2.2 A	S8VM-05024	---	---	S8VM-05024D	---	---		
	100 W		5 V	20 A	S8VM-10005	---	---	S8VM-10005D	---	---		
			12 V	8.5 A	S8VM-10012	---	---	S8VM-10012D	---	---		
			15 V	7 A	S8VM-10015	---	---	S8VM-10015D	---	---		
			24 V	4.5 A	S8VM-10024	---	---	S8VM-10024D	---	---		
	150 W		5 V	27 A	S8VM-15005 (See note 2.)	---	---	S8VM-15005D (See note 2.)	---	---		
			12 V	12.5 A	S8VM-15012	---	---	S8VM-15012D	---	---		
			15 V	10 A	S8VM-15015	---	---	S8VM-15015D	---	---		
			24 V	6.5 A	S8VM-15024	---	---	S8VM-15024D	---	---		
	Covered type		15 W	100 to 240 VAC	5 V	3 A	S8VM-01505C	---	---	S8VM-01505CD	---	---
					12 V	1.3 A	S8VM-01512C	---	---	S8VM-01512CD	---	---
					15 V	1 A	S8VM-01515C	---	---	S8VM-01515CD	---	---
					24 V	0.65 A	S8VM-01524C	S8VM-01524A (See note 1.)	---	S8VM-01524CD	S8VM-01524AD (See note 1.)	---
30 W		5 V	6 A		S8VM-03005C	---	---	S8VM-03005CD	---	---		
		12 V	2.5 A		S8VM-03012C	---	---	S8VM-03012CD	---	---		
		15 V	2 A		S8VM-03015C	---	---	S8VM-03015CD	---	---		
		24 V	1.3 A		S8VM-03024C	S8VM-03024A (See note 1.)	---	S8VM-03024CD	S8VM-03024AD (See note 1.)	---		
50 W		5 V	10 A		S8VM-05005C	---	---	S8VM-05005CD	---	---		
		12 V	4.3 A		S8VM-05012C	---	---	S8VM-05012CD	---	---		
		15 V	3.5 A		S8VM-05015C	---	---	S8VM-05015CD	---	---		
		24 V	2.2 A		S8VM-05024C	S8VM-05024A	S8VM-05024P	S8VM-05024CD	S8VM-05024AD	S8VM-05024PD		
100 W		5 V	20 A		S8VM-10005C	---	---	S8VM-10005CD	---	---		
		12 V	8.5 A		S8VM-10012C	---	---	S8VM-10012CD	---	---		
		15 V	7 A		S8VM-10015C	---	---	S8VM-10015CD	---	---		
		24 V	4.5 A		S8VM-10024C	S8VM-10024A	S8VM-10024P	S8VM-10024CD	S8VM-10024AD	S8VM-10024PD		
150 W		5 V	27 A		S8VM-15005C (See note 2.)	---	---	S8VM-15005CD (See note 2.)	---	---		
		12 V	12.5 A		S8VM-15012C	---	---	S8VM-15012CD	---	---		
		15 V	10 A		S8VM-15015C	---	---	S8VM-15015CD	---	---		
		24 V	6.5 A		S8VM-15024C	S8VM-15024A	S8VM-15024P	S8VM-15024CD	S8VM-15024AD	S8VM-15024PD		

- Note:**
- No outputs are built into these models.
 - The output capacity of the S8VM-15005□□ is 135 W.

Specifications

■ Ratings/Characteristics

Item	Power ratings	15 W	30 W	50 W	100 W	150 W	
Efficiency	5-V models	75% min.	75% min.	80% min.	81% min.	81% min.	
	12-V models	78% min.	79% min.	79% min.	81% min.	81% min.	
	15-V models	78% min.	79% min.	79% min.	81% min.	81% min.	
	24-V models	80% min.	81% min.	80% min.	82% min.	83% min.	
Input	Voltage (See note 1.)	100 to 240 VAC (85 to 264 VAC)					
	Frequency (See note 1.)	50/60 Hz (47 to 63Hz)					
	Current	100-V input	0.5 A max.	0.9 A max.	0.8 A max.	1.4 A max.	2.0 A max.
		200-V input	0.25 A max.	0.45 A max.	0.4 A max.	0.7 A max.	1.0 A max.
	Power factor	100-V input	---			0.98 min.	
		200-V input	---			0.94 min.	
	Harmonic current emissions	---			Conforms to EN 61000-3-2		
	Leakage current	100-V input	0.4 mA max. (at rated output)				
		200-V input	0.75 mA max. (at rated output)				
	Inrush current (See note 2.)	100-V input	17.5 A max. (for cold start at 25°C)				
200-V input		35 A max. (for cold start at 25°C)					
Output	Voltage adjustment range (See note 3.)	-20% to 20% (with V. ADJ) (S8VM-□□□24A□/P□: -10% to 20%)					
	Ripple	3.2% (p-p) max. (5 V), 1.5% (p-p) max. (12 V), 1.2% (p-p) max. (15 V), 1.0% (p-p) max. (24 V), (at rated input/output voltage)		3.2% (p-p) max. (5 V), 1.5% (p-p) max. (12 V), 1.2% (p-p) max. (15 V), 0.75% (p-p) max. (24 V), (at rated input/output voltage)			
	Input variation influence	0.4% max. (at 85 to 264 VAC input, 100%)					
	Load variation influence (rated input voltage)	0.8% max. (with rated input, 0 to 100% load)					
	Temperature variation influence	0.02%/°C max.					
	Start up time (See note 2.)	1,100 ms max. (at rated input/output voltage)	800 ms max. (at rated input/output voltage)				
	Hold time (See note 2.)	20 ms typ. (15 ms min.) (at rated input/output voltage)					
Additional functions	Overload protection (See note 2.)	105% to 160% of rated load current, voltage drop, intermittent, automatic reset		105% to 160% of rated load current, voltage drop (12 V, 15 V, and 24 V), voltage drop, intermittent (5 V), automatic reset			
	Overvoltage protection (See note 2.)	Yes (See note 4.)					
	Undervoltage alarm indication	Yes (color: yellow (DC LOW1), red (DC LOW2)) (S8VM-□□□24A□/P□ only)					
	Undervoltage alarm output	No			Yes (S8VM-□□□24A□/P□ only) (Transistor output), 30 VDC max., 50 mA max.) (See note 9.)		
	Series operation	Yes					
	Parallel operation	No					
Remote sensing function	No				Yes		
Other	Operating ambient temperature	Refer to the derating curve in <i>Engineering Data</i> . (with no icing or condensation) (See note 2.)					
	Storage temperature	-25 to 65°C					
	Operating ambient humidity	30% to 85% (Storage humidity: 25% to 90%)					
	Dielectric strength	3.0 kVAC for 1 min. (between all inputs and outputs; detection current: 20 mA) 2.0 kVAC for 1 min. (between all inputs and PE/FG terminals; detection current: 20 mA) 500 VAC for 1 min. (between all outputs and PE/FG terminals; detection current: 100 mA) 500 VAC for 1 min. (between all outputs (except the detection output terminals) and detection output terminals; detection current: 20 mA) (S8VM-□□□24A□/P□ only)					
	Insulation resistance	100 MΩ min. (between all outputs and all inputs, PE/FG terminals) at 500 VDC					
	Vibration resistance	10 to 55 Hz, 0.375-mm single amplitude for 2 hours each in X, Y, and Z directions					
	Shock resistance	150m/s ² , 3 times each in ±X, ±Y, ±Z directions					
	Output indicator	Yes (color: green)					
	EMI	Conducted Emission	Conforms to EN61204-3 EN55011 Class B and based on FCC Class B (See note 5.)				
		Radiated Emission	Conforms to EN61204-3 EN55011 Class B (See note 6.)				
	EMS	Conforms to EN61204-3 High severity levels					
	Approved standards (See note 7.)	UL: UL508 (Listing), UL60950-1, UL1604 (Class I/Division 2) CSA: cUL: C22.2 No.14, cUR: No. 60950-1, No.213 (Class I/Division 2) EN: EN50178, EN60950-1 SELV (EN60950-1) According to VDE0160/P100					
	Weight (See note 8.)	180 g max.	220 g max.	290 g max.	460 g max.	530 g max.	

- Note:**
- Do not use the Inverter output for the Power Supply. Inverters with an output frequency of 50/60 Hz are available, but the rise in the internal temperature of the Power Supply may result in ignition or burning.
 - Refer to the *Engineering Data* section on page 7 to 8 for details.
 - If the V. ADJ adjuster is turned, the voltage will increase by more than +20% of the voltage adjustment range. When adjusting the output voltage, confirm the actual output voltage from the Power Supply and be sure that the load is not damaged.
 - To reset the protection, turn OFF the input power for three minutes or longer and then turn it back ON.
 - Conducted emissions: The noise value is affected by factors such as the wiring method. The product conforms to Class B when the aluminum plate is laid under the product. For 15-W models, insert a clamp filter (ZCAT2436-1330 by TDK: 50 Ω min. [50 to 500 MHz], or the equivalent) in the output wire to reduce noise.
 - Radiated emissions: The noise value is affected by factors such as the wiring method. The product conforms to Class B when the aluminum plate is laid under the product. For 150-W models, insert a clamp filter (ZCAT2017-0930 by TDK: 35 Ω min. [50 to 500 MHz], or the equivalent) in the input wire to reduce noise.
 - UL1604 (Class I/Division 2) and CSA C22.2 No. 213 (Class I/Division 2) approval pending for 150-W models. However, S8VM-15024□□ models are designed for compliance with an output rated current of 6.3 A max.
 - The weight indicated is for front-mounting, open-frame models.
 - A□: Sinking type (NPN)
P□: Sourcing type (PNP)

OMRON

Connections

Block Diagrams

S8VM-015□□□□ (15 W)

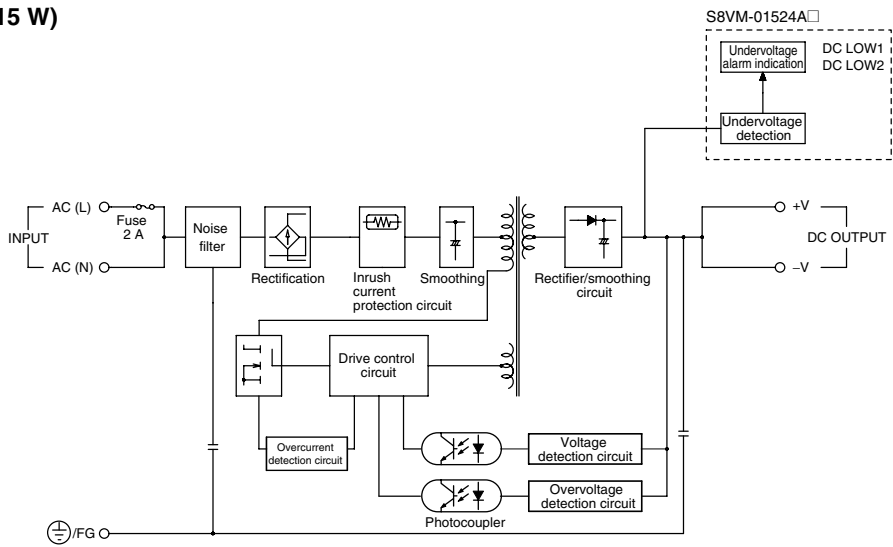

S8VM-030□□□□ (30 W)

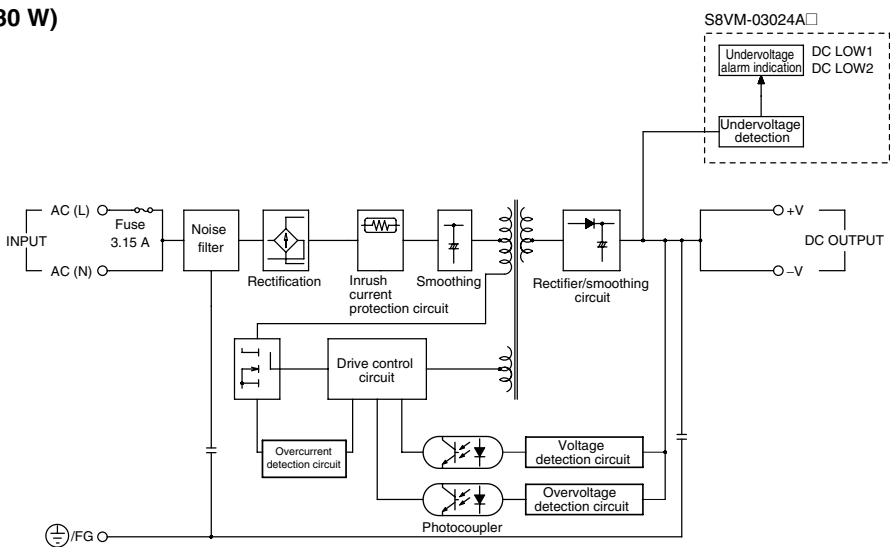

S8VM-050□□□□ (50 W)

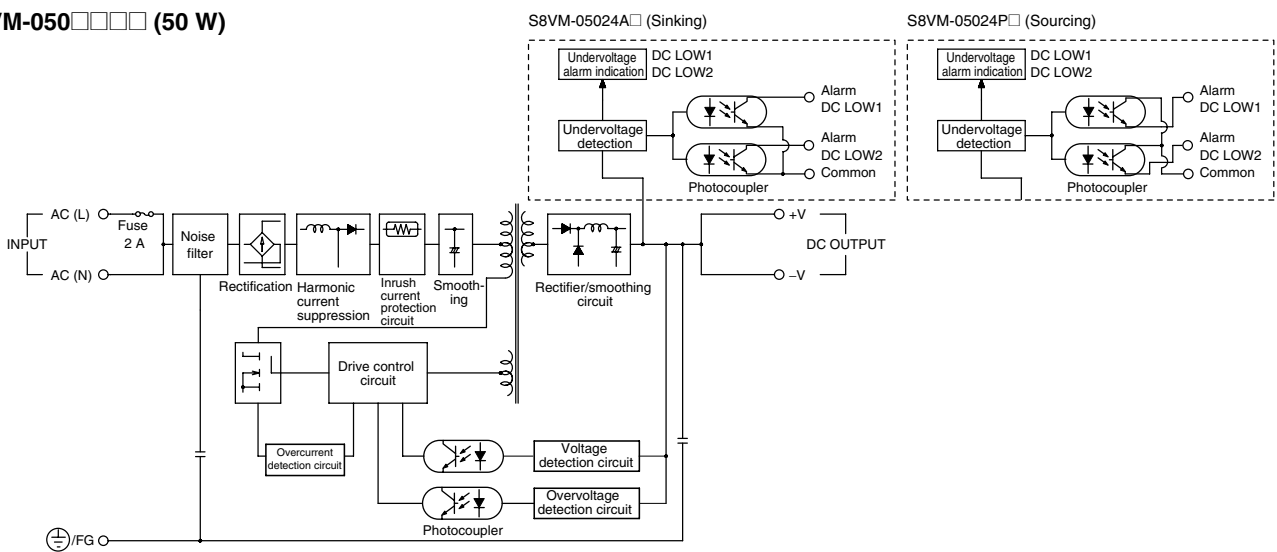

S8VM-100 (100 W)

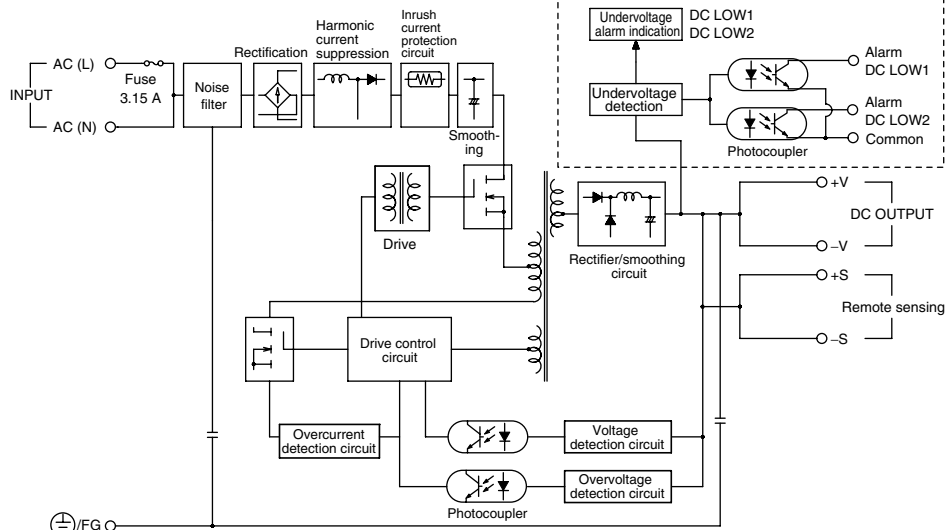

S8VM-10024A (Sinking)

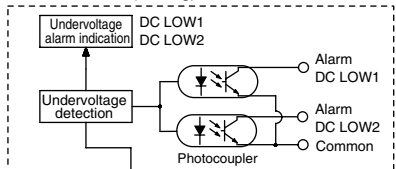

S8VM-10024P (Sourcing)

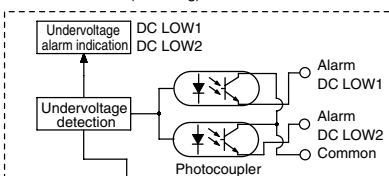

S8VM-150 (150 W)

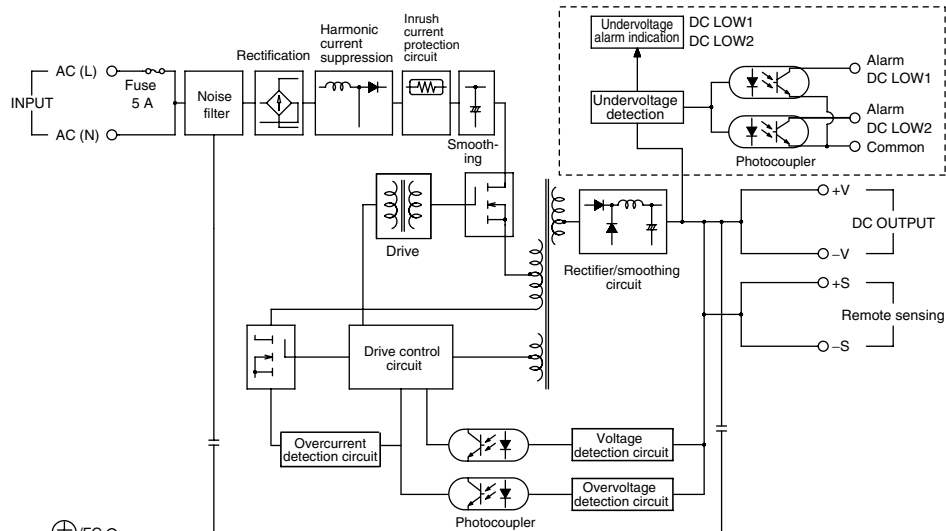

S8VM-15024A (Sinking)

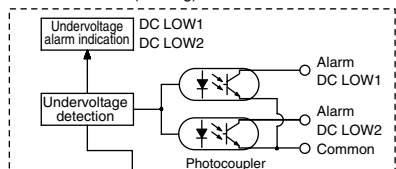

S8VM-15024P (Sourcing)

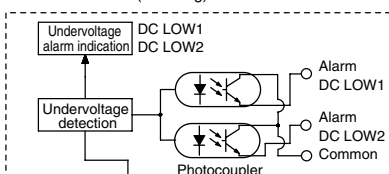

Construction and Nomenclature

Nomenclature

15-W, 30-W, 50-W Models

Open-frame types

S8VM-015□□/S8VM-015□□D
 S8VM-030□□/S8VM-030□□D
 S8VM-050□□/S8VM-050□□D

Covered types

S8VM-015□□C□/S8VM-01524A□
 S8VM-030□□C□/S8VM-03024A□
 S8VM-050□□C□/S8VM-05024A□/P□

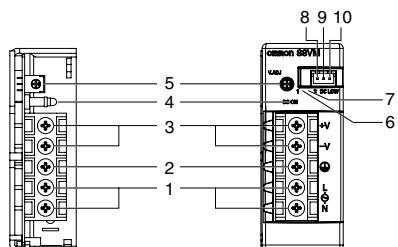

100-W Models

Open-frame types

S8VM-100□□/S8VM-100□□D

Covered types

S8VM-100□□C□/S8VM-10024A□/P□

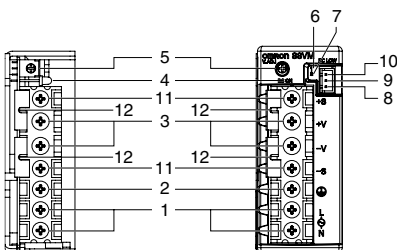

150-W Models

Open-frame types

S8VM-150□□/S8VM-150□□D

Covered-types

S8VM-150□□C□/S8VM-15024A□/P□

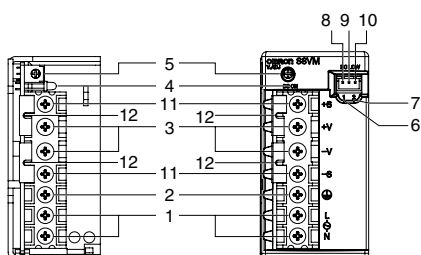

No.	Name	Function
1	AC input terminals (L). (N)	Connect the input lines to these terminals. (See note 1.)
2	PE terminal: Protective earthing terminal (S8VM-□□□□C□/S8VM-□□□□A□/ S8VM-□□□□P□) FG terminal: Frame ground terminal (S8VM-□□□□□/ S8VM-□□□□□D)	Connect the ground line to this terminal. (See note 2.)
3	DC output terminals (-V). (+V)	Connect the load lines to these terminals.
4	Output indicator (DC ON: Green)	Lights (green) while a direct current (DC) output is ON.
5	Output voltage adjuster (V. ADJ)	Use to adjust the voltage.
6	Undervoltage alarm indicator 1 (DC LOW1: Yellow) (See note 3.)	Lights only when a momentary drop in output voltage is detected. This status is maintained.
7	Undervoltage alarm indicator 2 (DC LOW2: Red) (See note 3.)	Lights only when the output voltage drops to approximately 20 V or lower.
8	Undervoltage alarm output terminal 1: (DC LOW1) (See note 4.)	Outputs only when a momentary drop in output voltage is detected. This status is maintained. (The transistor turns OFF when a voltage drop occurs.)
9	Undervoltage alarm output terminal 2: (DC LOW2) (See note 4.)	Outputs only when the output voltage drops to approximately 20 V or lower. (The transistor turns OFF when a voltage drop occurs.)
10	Common terminal for undervoltage alarm output (See note 4.)	Common terminal (See note 6.) for terminals 8 and 9
11	Remote sensing terminals (See note 5.)	Correct the voltage drop in the load lines.
12	Short bars (See note 5.)	---

Note: 1. The fuse is located on the (L) side. It is NOT user-replaceable.

2. Protective earthing connection is the panel mounting hole shown in the figure below.

(A protective earthing connection stipulated in safety standards is used. Connect the ground completely (S8VM-□□□□D only).

Ground terminal: M3 (Depth: 8 mm max.)/Ground wire: AWG 18

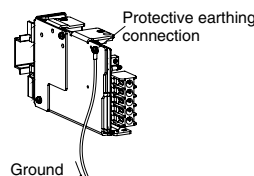

3. S8VM-□□□□24A□/P□ only

4. S8VM-05024A□/P□, S8VM-10024A□/P□, S8VM-15024A□/P□ only. Housing and terminals of the connector for undervoltage detection output are also provided. For details, refer to *XH Connector Preparation* on page 20 under *Safety Precautions*.

5. When not using the remote sensing function, leave the short bar in the same state as when shipped.

6. A□ models: Common terminal (emitter)
 P□ models: Common terminal (collector)

Output Color Label

This color label identifies the output voltage by color.

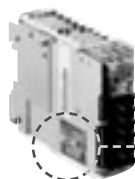

Green: 5 V
 Blue: 12 V
 Yellow: 15 V
 White: 24 V

--- Color label identifying output voltage

Engineering Data

Derating Curve

S8VM-15W/30W

Standard mounting/Horizontal mounting/Face-up mounting

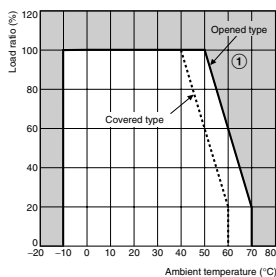

S8VM-50W

Standard mounting/Horizontal mounting

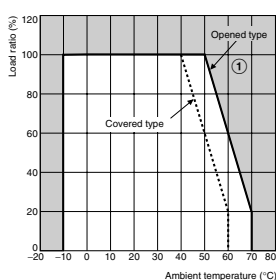

Face-up mounting

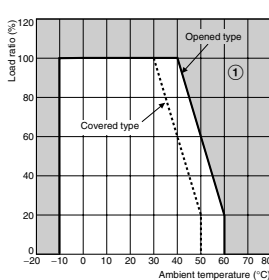

S8VM-100W

Standard mounting

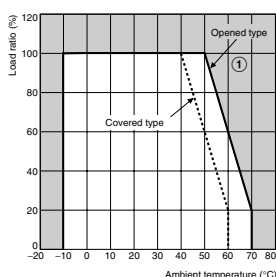

Horizontal mounting/Face-up mounting

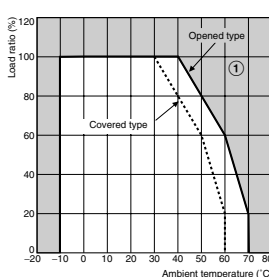

S8VM-150W

Standard mounting

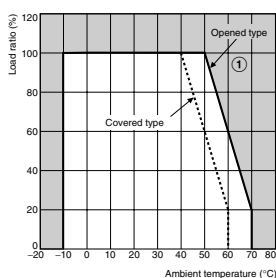

Horizontal mounting

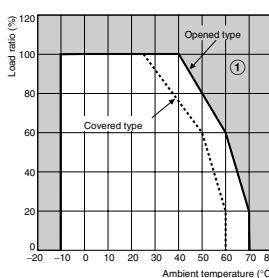

Face-up mounting

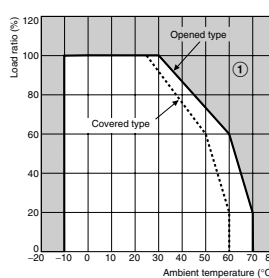

- Note:**
1. Internal parts may occasionally be deteriorated or damaged. Do not use the Power Supply in areas outside the derating curves (i.e., the area shown by shading ① in the above graphs).
 2. If there is a derating problem, use forced air-cooling.
 3. When mounting two or more Power Supplies side-by-side, allow at least 20 mm spacing between them. Multiple 100- and 150-W models cannot be used side by side. Be sure to install the Power Supplies as far away from heat-generating sources as possible. As a reference value, allow at least 50 mm spacing on the right and left sides. If only 20 mm spacing is allowed, use the Power Supply at a load ratio of 80% or less.
 4. When using 150-W models for a long period of time at an input voltage of 90 VAC or lower, reduce the load to 80% or less of the above derating curves.

■ Mounting

Standard mounting
(DIN Rail mounting bracket type)

Correct

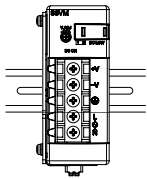

Standard mounting
(Front-mounting type)

Correct

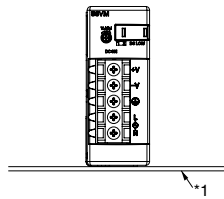

Horizontal mounting
(Front-mounting type)

Correct

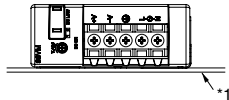

Face-up mounting
(DIN Rail mounting bracket type)

Incorrect

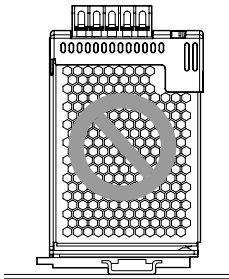

Face-up mounting
(Front-mounting type)

Correct

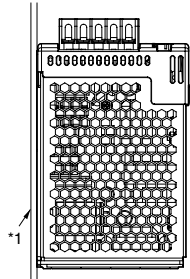

Face-down mounting
(DIN Rail mounting bracket type)

Incorrect

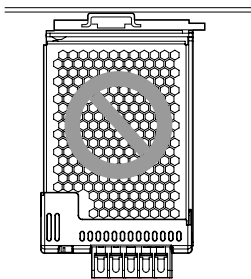

Face-down mounting
(Front-mounting type)

Incorrect

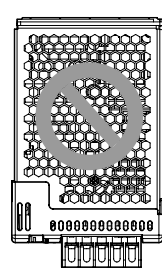

- Note:** 1. Improper mounting will interfere with heat dissipation and may occasionally result in deterioration or damage of internal parts. Use the product within the derating curve for the mounting direction that is used.
2. Use the metal plate as the mounting panel (*1).
3. Install the Power Supply so that the air flow circulates around the Power Supply, as the Power Supply is designed to radiate heat by means of natural air flow.
4. Mounting screw tightening torque (recommended value: 0.49 N·m)

■ Remote Sensing Function (S8VM-100□□□□/150□□□□ only)

This function compensates a voltage drop on the load lines. To use this function, connect after removing the two short bars of the remote sensing terminal.

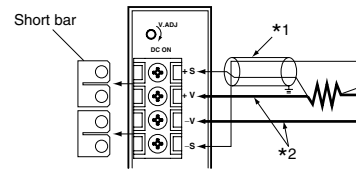

- Note:** 1. Use a 2-conductor shielded cable as a connection wire (*1).
2. Use as thick a wire as possible since high voltage drops on the load lines (*2) may activate the overvoltage protection function.
3. Use when the voltage drop is 0.3 V or lower.
4. When the +S and -S terminals are opened with the short bar removed, the overvoltage protection function is activated and the output voltage will be cut off.
5. If the load line is too long, use an electrolytic capacitor in the following 3 locations:
- 1) Across the load terminals
 - 2) Between the +S terminal and + terminal
 - 3) Between the -S terminal and -terminal
- Select the capacity of the connected capacitor from between several tens to several hundreds of μF as a guide, and then determine the capacity when actually connecting the capacitor between terminals as shown below.

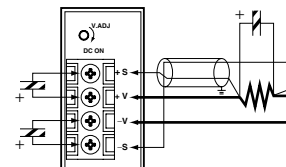

■ Inrush Current, Start Up Time, Output Hold Time

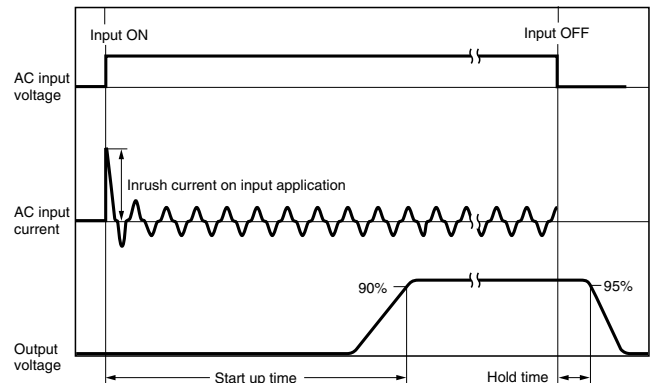

■ Reference Values

Item	Value	Definition
Reliability (MTBF)	135,000 hrs min.	MTBF stands for Mean Time Between Failures, which is calculated according to the probability of accidental device failures, and indicates the reliability of a device. Therefore, it does not necessarily represent the life of the product.
Life expectancy	10 yrs. min.	The life expectancy indicates average operating hours under the ambient temperature of 40° C and a load rate of 50%. Normally this is determined by the life expectancy of the built-in aluminum electrolytic capacitor.

Overload Protection

The Power Supply is provided with an overload protection function that protects the Power Supply from possible damage by short-circuit and overcurrent.

When the output current rises above 105% min. of the rated current, the protection function is triggered, automatically decreasing the output voltage. When the output current falls within the rated range, the overload protection function is automatically cleared.

15/30W

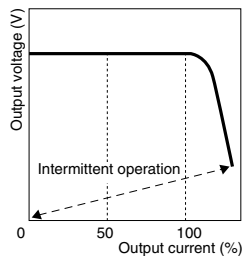

50/100/150W (5 V)

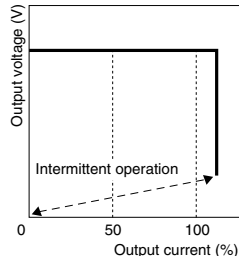

50/100/150W (12 V, 15 V, 24 V)

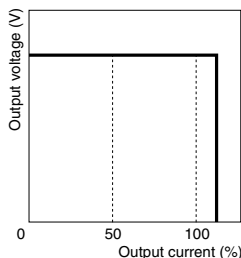

The values shown in the above diagrams are for reference only.

- Note:**
- Internal parts may occasionally deteriorate or be damaged if a short-circuited or other overcurrent state continues during operation. Eliminate the overcurrent state as soon as possible.
 - Internal parts may possibly be deteriorated or damaged if the Power Supply is used for applications with frequent inrush current or overloading at the load end. Do not use the Power Supply for such applications.

Overvoltage Protection

Consider the possibility of an overvoltage and design the system so that the load will not be subjected to an excessive voltage even if the feedback circuit in the Power Supply fails. When an excessive voltage that is approximately 140% of the rated voltage or more is output, the output voltage is shut OFF, preventing damage to the load due to overvoltage. Reset the input power by turning it OFF for at least three minutes and then turning it back ON again.

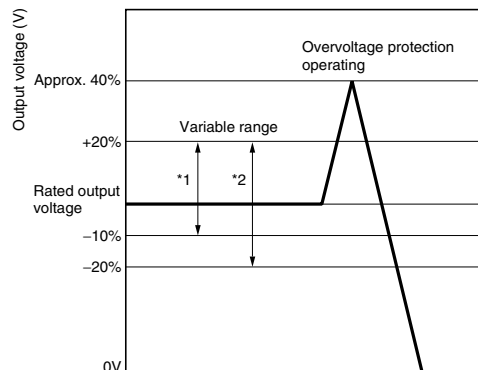

The values shown in the above diagram are for reference only.

*1 S8VM-□□□24A□/P□

*2 Except for S8VM-□□□24A□/P□

- Note:**
- Do not turn ON the input power again until the cause of the overvoltage has been removed.
 - The overvoltage protection function may be activated when the output voltage adjuster (V.ADJ) is set to a value that exceeds +20% of the rated output voltage.

Undervoltage Alarm Function (Indication and Output)

(Only S8VM-□□□24A□/P□)

If an output voltage drop is detected with an S8VM-□□□24A□/P□ with undervoltage alarm function, the DC LOW indicator will light to notify of an output error. The transistor also sends an output externally to notify of the error (except for the S8VM-01524A□ and S8VM-03024A□).

Transistor Output: Sinking type: (NPN) (S8VM-□□□24A□) Leakage current when OFF: 0.1 mA or less
 Sourcing type: (PNP) (S8VM-□□□24P□)
 30 VDC max., 50 mA max. Residual voltage when ON: 2 V or less

S8VM-01524A□
 S8VM-03024A□

S8VM-05024A□/P□

S8VM-10024A□/P□

S8VM-15024A□/P□

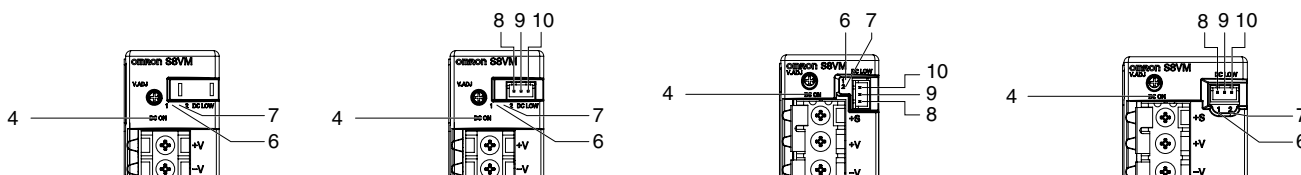

Undervoltage Alarm Function 1 (DC LOW1)

Only a momentary voltage drop is detected. Detection voltage is automatically adjusted internally by detecting the output voltage (approx. 2.7 V lower than the voltage output at an output voltage of 24.0 V). During detection, the transistor is OFF (with no continuity across 8 and 10) and the LED (6: Yellow) lights. (The Undervoltage Alarm Function 1 is used as a latch holding function.)

Undervoltage Alarm Function 2 (DC LOW2)

Detection voltage is set to approx. 20.0 V (from 18.0 to 21.6 V). During detection, the transistor is OFF (with no continuity across 9 and 10) and the LED (7: Red) lights.

- Note:**
- This function monitors the voltage at the Power Supply output terminals. To check actual voltage, measure voltage on the load side.
 - Gradual voltage drop is not detected by the Undervoltage Alarm Function 1 (DC LOW1).
 - Once undervoltage is detected by Undervoltage Alarm Function 1 (DC LOW1), the transistor turns OFF and status of the LED (6: Yellow) light is maintained. To reset the function, turn OFF the input power for 60 seconds or longer, and then turn it ON again.
 - If the output voltage remains at 15 V or lower for several seconds when using Undervoltage Alarm Function 1 (DC LOW 1), the output hold status for detection may be reset.

Probable Causes of Power Supply Errors and Troubleshooting Using Undervoltage Alarm Function

Check the following information if the Undervoltage Alarm Function operates.

Contact your OMRON representative if the Power Supply does not function normally after checking.

The symbols in the table are as follows:

● : Lit, ○ : Not lit, ⊗ : Flashing

Note: Flashing: The output voltage is unstable, causing the LED to repeatedly turn ON and OFF.

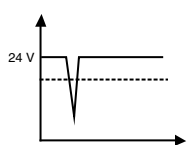
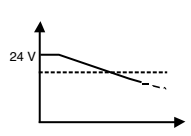
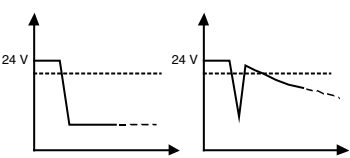
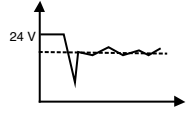
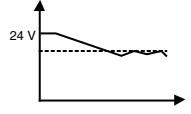
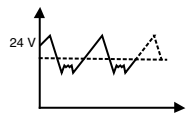
	DC ON		DC LOW1		DC LOW2		Output voltage	Power Supply status diagnosis	
	LED (4): Green	LED (6): Yellow	Transistor outputs (8 to 10)	LED (7): Red	Transistor outputs (9 to 10)				
1	●	○	ON	○	○	ON	→ Normal (approx. 90% min. of rated output voltage)	Normal status	
2	●	●	OFF	○	○	ON	→ Normal (approx. 90% min. of rated output voltage)	The output voltage has recovered to normal status following a previous sudden voltage drop.	
3	●	○	ON	●	○	OFF	→ Output drop (approx. 90% max. of rated output voltage)	The output voltage has dropped gradually and remains low.	
4	●	●	OFF	●	○	OFF	→ Output drop (approx. 90% max. of rated output voltage)	The output voltage remains low following a previous sudden voltage drop.	
5	●	●	OFF	⊗	○	ON ↕ OFF	→ Output drop (approx. 80% of rated output voltage)	The output voltage remains low and is continuing to fluctuate following a previous sudden voltage drop.	
6	●	○	ON	⊗	○	ON ↕ OFF	→ Output drop (approx. 80% of rated output voltage)	The output voltage has dropped gradually, remains low, and is continuing to fluctuate.	
7	○	○	OFF	○	○	OFF	→ No output	No output voltage is being output.	
8	⊗	⊗	ON ↕ OFF	⊗	○	ON ↕ OFF	→ Unstable output	The output voltage is unstable.	

Probable cause of error	Troubleshooting methods	
---	---	1
A momentary power failure has occurred in the input.	Check that the output voltage is normal and no problems have occurred in other devices. No problems will be caused by continuing to use the Power Supply as is. To clear DC LOW1 (LED display and transistor output status), turn OFF the input power, and wait at least 60 s before turning ON the input Power Supply again.	
A momentary overload has occurred.	The load current has probably exceeded the rated current. We suggest reducing the connected load or replace the Power Supply with one that has a higher capacity.	
A momentary output voltage drop has occurred at startup due to the capacity of the capacitive factors on the load side or when the load is activated.	A large inrush current has probably flowed to the load side at startup. We suggest replacing the Power Supply with one that has a higher capacity.	2
The output voltage has returned to normal voltage following a rapid drop caused by using the output voltage adjuster (V.ADJ).	Turn OFF the input power, and wait at least 60 s before turning ON the input power again to clear the indicator status.	
Deterioration due to age (when the Power Supply has been used for several years)	The internal parts of the Power Supply may have deteriorated due to age. We suggest replacing the Power Supply. Also replace other Power Supplies that were purchased at the same time.	
Overload (immediately following first use of the Power Supply or when increasing the load)	The load current has probably exceeded the rated current. Check the actual load current and Power Supply capacity. Continued use in overload status may damage the Power Supply.	3
The output voltage dropped to -10% or lower of the rated voltage resulting from using the output voltage adjuster (V.ADJ)	Adjust the output voltage to the rated values using the output voltage adjuster (V.ADJ).	
A sudden overload occurred and the Power Supply remains in overload status.	An error has probably occurred in the load device. Turn OFF the input power, and check whether any errors have occurred in the load device. Continued use in overload status may damage the Power Supply.	4
The output voltage remains low after a rapid voltage drop caused by using the output voltage adjuster (V.ADJ).	Adjust the output voltage to the rated values using the output voltage adjuster (V.ADJ). To clear DC LOW1 (LED display and transistor output status), turn OFF the input power, and wait at least 60 s before turning ON the input power again.	4
The overload status continues to fluctuate following a sudden overload.	An error has probably occurred in the load device. Turn OFF the input power, and check whether any errors have occurred in the load device. Continued use in overload status may damage the Power Supply.	5
Deterioration due to age (after using the Power Supply for several years)	The internal parts of the Power Supply may have deteriorated due to age. Replace the Power Supply. Also replace other Power Supplies that were purchased at the same time.	6
Overload (immediately following first use of the Power Supply or when increasing the load)	The load current has probably exceeded the rated current. Check the actual load current and Power Supply capacity. Continued use in overload status may damage the Power Supply.	6
Power Supply interrupted or damaged.	Check whether the input power is being applied correctly. If there is no output even though the input power is applied correctly, the internal circuit is probably damaged.	
Overvoltage protection operation	Turn OFF the input power, and wait at least 3 min before turning ON the input power again. If the same status recurs, the internal circuit is probably damaged.	7
The short bar has fallen off, or the +S and -S terminals are open.	Check whether the +S and -S terminals are open. If so, the overvoltage protection function is activated. Therefore, turn OFF the input power and wait at least three minutes before turning it ON again. (S8VM-10024A□/P□ and S8VM-15024A□/P□ models only)	7
Output short-circuit	Remove the cause of the output short-circuit.	
Intermittent operation due to overload (S8VM-01524A□/03024A□ only)	The load current has probably exceeded the rated current. Check the actual load current and Power Supply capacity. Continued use in overload status may damage the Power Supply.	
The Power Supply fails to start repeatedly due to the capacity of the capacitive factors on the load side.	A large inrush current has probably flowed to the load side at startup. We suggest replacing the Power Supply with one that has a higher capacity.	8
The input turns ON and OFF repeatedly.	Check whether the Power Supply's input voltage is being applied correctly.	
The status repeatedly switches between normal operation and output short-circuit.	An error has probably occurred in the load device. Turn OFF the input power, and check whether any errors have occurred in the load device.	

Dimensions

Note: All units are in millimeters unless otherwise indicated.

Front-mounting Models

S8VM-015□□
S8VM-015□□C
S8VM-01524A

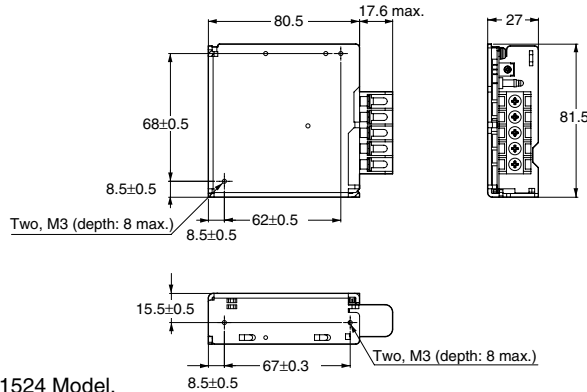
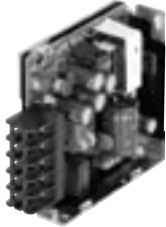

Note: The image is the S8VM-01524 Model.

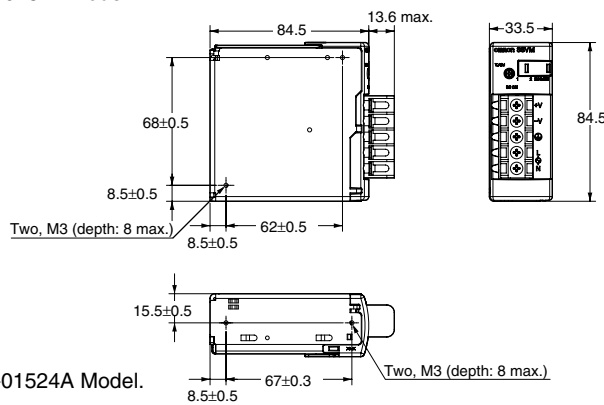
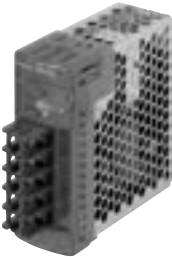

Note: The image is the S8VM-01524A Model.

Mounting Holes

	Surface Screw Mounting
Side Mounting	Two, 4 dia.
Bottom Mounting	Two, 4 dia.

S8VM-030□□
S8VM-030□□C
S8VM-03024A

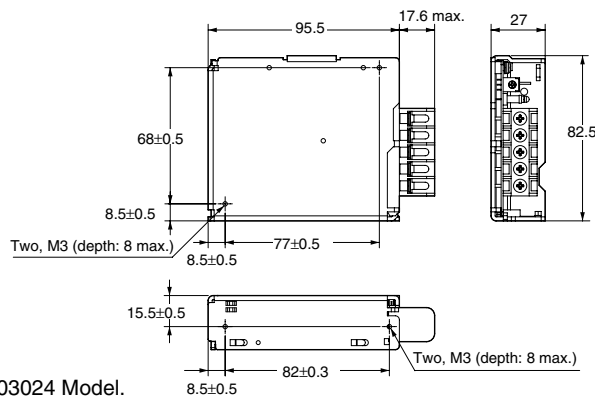
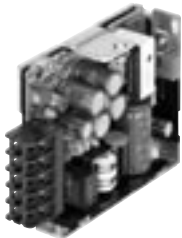

Note: The image is the S8VM-03024 Model.

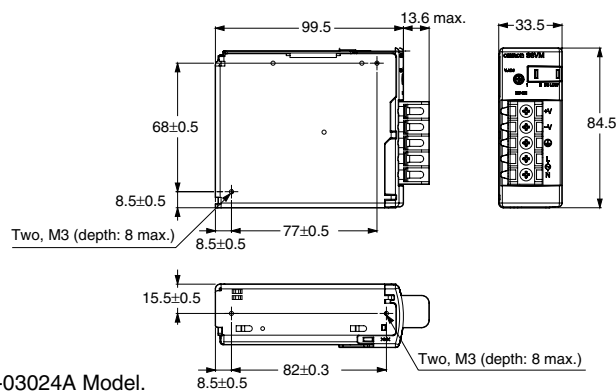
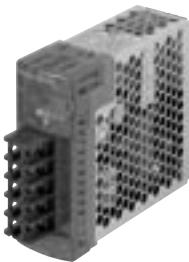

Note: The image is the S8VM-03024A Model.

Mounting Holes

	Surface Screw Mounting
Side Mounting	Two, 4 dia.
Bottom Mounting	Two, 4 dia.

S8VM-050□□
 S8VM-050□□C
 S8VM-05024A
 S8VM-05024P

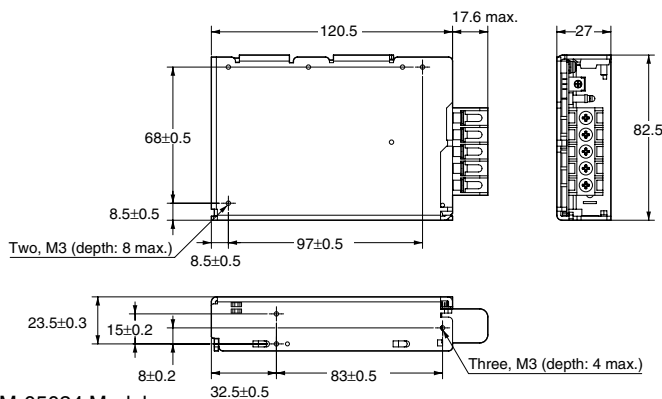
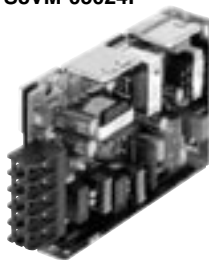

Mounting Holes

Surface Screw Mounting	
Side Mounting	Two, 4 dia.
Bottom Mounting	Three, 4 dia.

Note: The image is the S8VM-05024 Model.

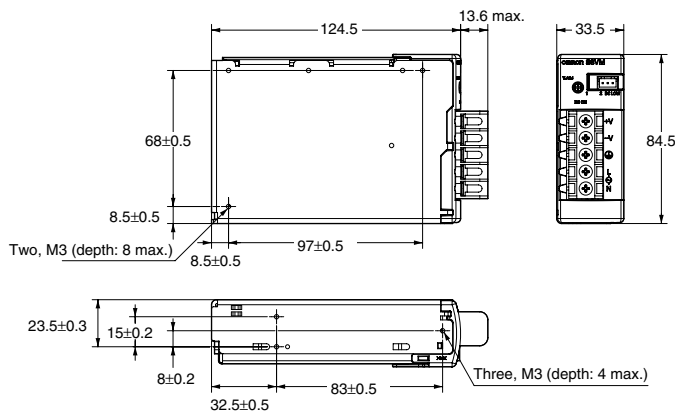
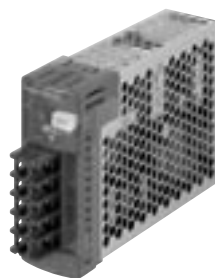

Note: The image is the S8VM-05024A Model.

S8VM-100□□
 S8VM-100□□C
 S8VM-10024A
 S8VM-10024P

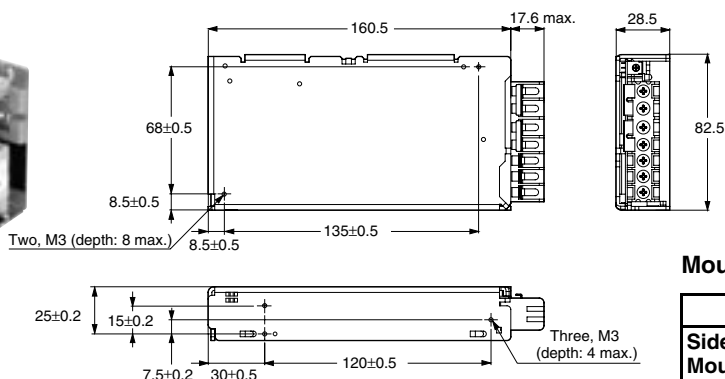
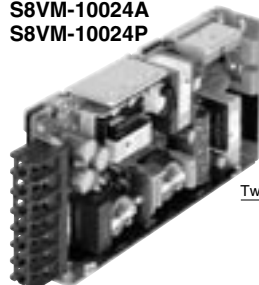

Mounting Holes

Surface Screw Mounting	
Side Mounting	Two, 4 dia.
Bottom Mounting	Three, 4 dia.

Note: The image is the S8VM-10024 Model.

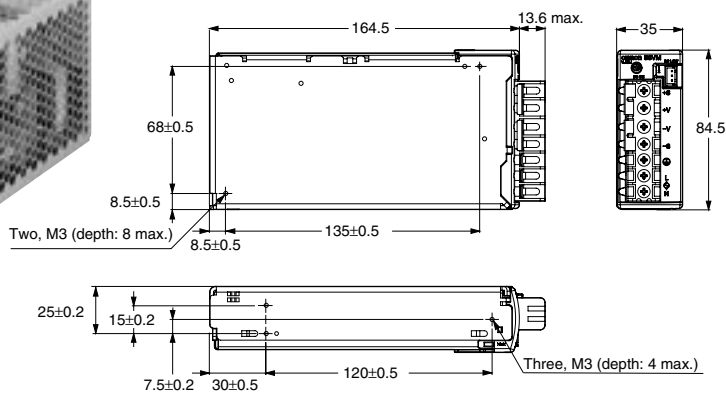
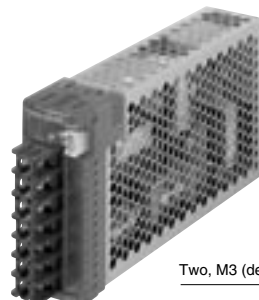

Note: The image is the S8VM-10024A Model.

S8VM-150□□
 S8VM-150□□C
 S8VM-15024A
 S8VM-15024P



Mounting Holes

Surface Screw Mounting	
Side Mounting	<p>Two, 4 dia.</p>
Bottom Mounting	<p>Three, 4 dia.</p>

Note: The image is the S8VM-15024 Model.

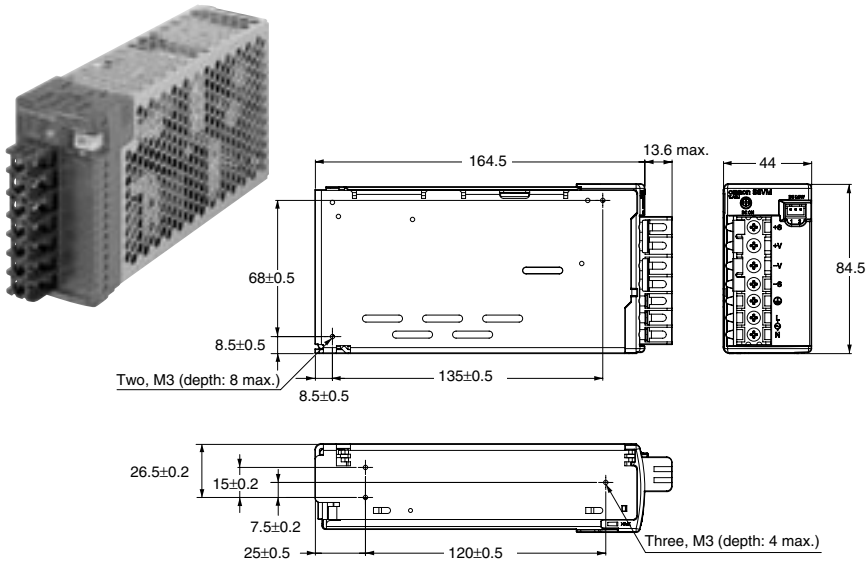

Note: The image is the S8VM-15024A Model.

■ DIN Rail Mounting Bracket Models

S8VM-015□□D
 S8VM-015□□CD
 S8VM-01524AD

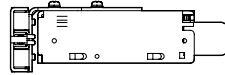
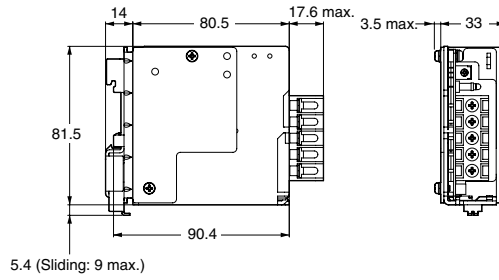
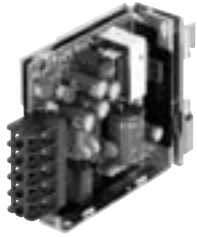

Note: The image is the S8VM-01524D Model.

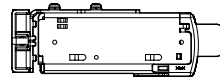
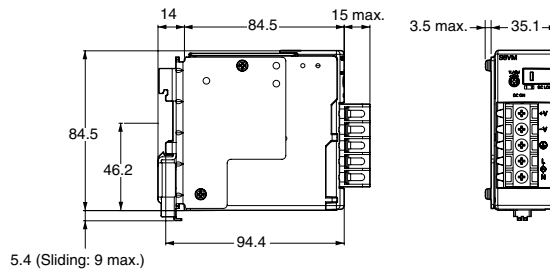
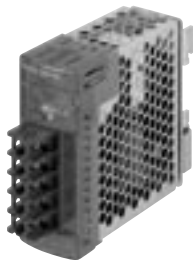

Note: The image is the S8VM-01524AD Model.

S8VM-030□□D
 S8VM-030□□CD
 S8VM-03024AD

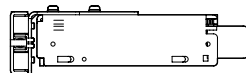
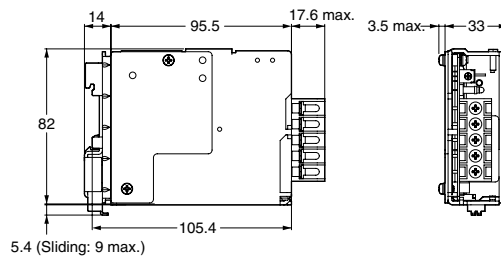
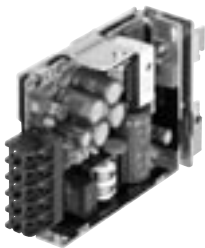

Note: The image is the S8VM-03024D Model.

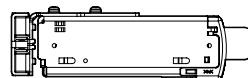
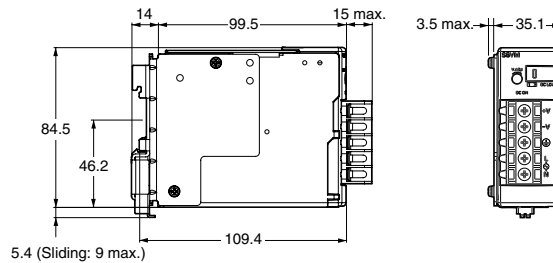
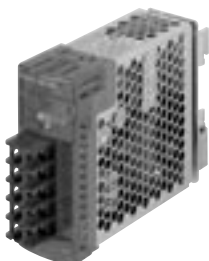

Note: The image is the S8VM-03024AD Model.

S8VM-050□□D
 S8VM-050□□CD
 S8VM-05024AD
 S8VM-05024PD

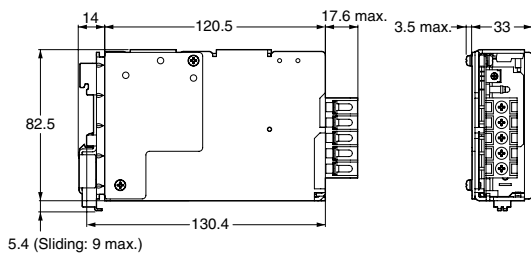
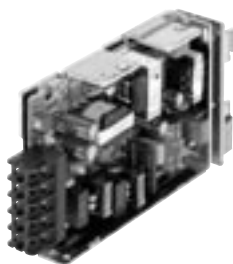

Note: The image is the S8VM-05024D Model.

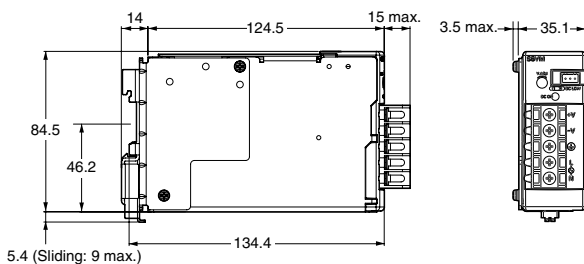
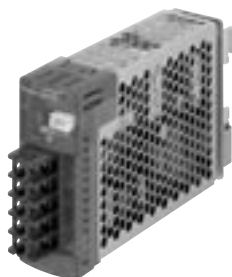

Note: The image is the S8VM-05024AD Model.

S8VM-100□□D
 S8VM-100□□CD
 S8VM-10024AD
 S8VM-10024PD

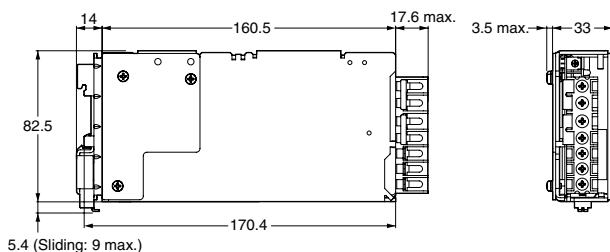
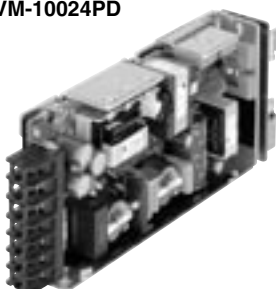

Note: The image is the S8VM-10024D Model.

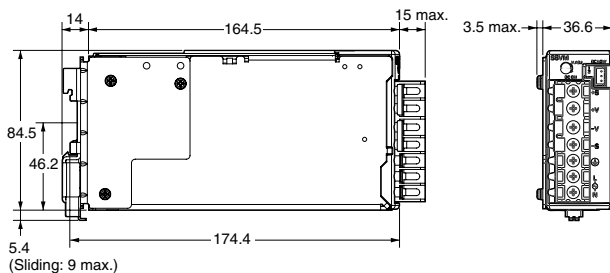
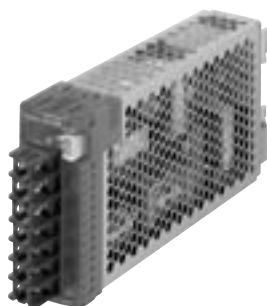

Note: The image is the S8VM-10024AD Model.

S8VM-150□□D
 S8VM-150□□CD
 S8VM-15024AD
 S8VM-15024PD

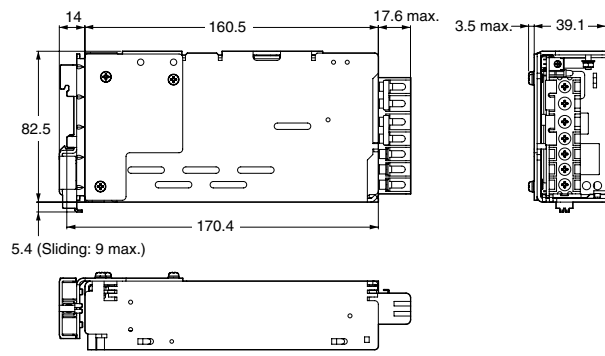

Note: The image is the S8VM-15024D Model.

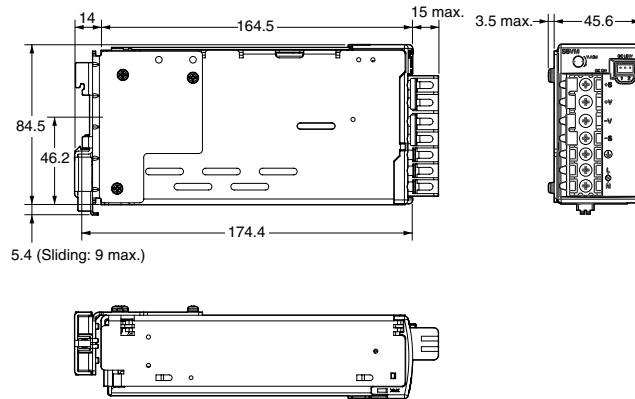
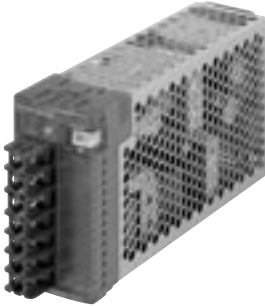

Note: The image is the S8VM-15024AD Model.

■ DIN Rail (Order Separately)

Note: All units are in millimeters unless otherwise indicated.

Mounting Rail (Material: Aluminum)

PFP-100N
PFP-50N

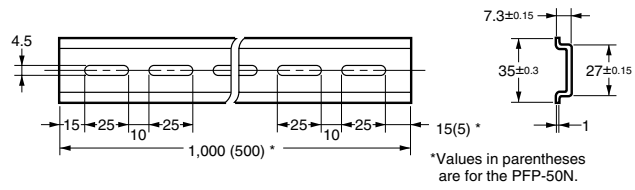
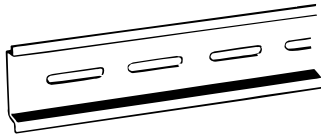

Mounting Rail (Material: Aluminum)

PFP-100N2

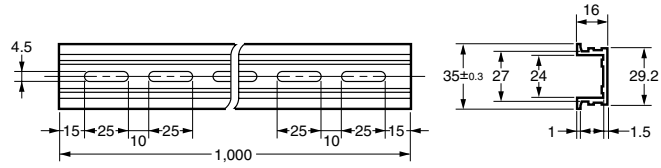
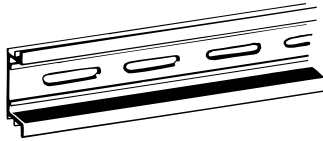

Safety Precautions

CAUTION

Minor electric shock, fire, or Product failure may occasionally occur. Do not disassemble, modify, or repair the Product or touch the interior of the Product.



Minor burns may occasionally occur. Do not touch the Product while power is being supplied or immediately after power is turned OFF.



Fire may occasionally occur. Tighten terminal screws to the specified torque of 1.6 N·m.



Minor injury due to electric shock may occasionally occur. Do not touch the terminals while power is being supplied.



Minor electric shock, fire, or Product failure may occasionally occur. Do not allow any pieces of metal or conductors or any clippings or cuttings resulting from installation work to enter the Product.



Precautions for Safe Use

Mounting

Standard mounting (DIN Rail mounting bracket type)

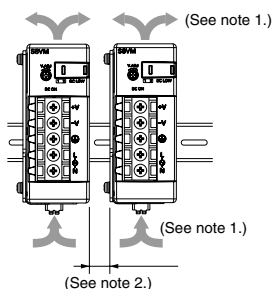

Standard mounting (Front-mounting type)

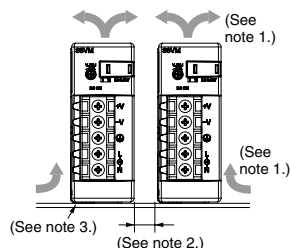

Horizontal mounting (Front-mounting type)

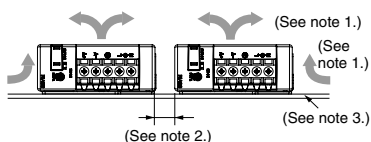

Face-up mounting (Front-mounting type)

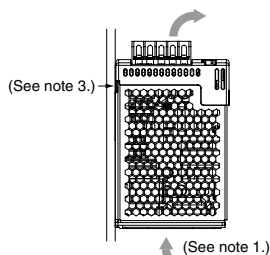

- Note: 1.** Convection of air
2. 20 mm or more
 3. Use a metal plate as the mounting panel.

Take adequate measures to ensure proper heat dissipation to increase the long-term reliability of the Product. Be sure to allow convection in the atmosphere around devices when mounting. Do not exceed the range of the derating curve.

Use the metal plate as the mounting panel.

When cutting out holes for mounting, make sure that cuttings do not enter the interior of the Product.

Improper mounting will interfere with heat dissipation and may occasionally result in deterioration or damage of internal parts. Use the Product within the derating curve for the mounting direction that is used.

When mounting two or more Power Supplies side-by-side, allow at least 20 mm spacing between them, as shown in the above illustrations.

The internal parts may possibly be damaged if mounting screws are over inserted. Refer to *Dimensions* on page 12 for maximum depth of insertion inside the Power Supply.

Several Power Supplies cannot be connected. (Only S8VM-100□□□□/150□□□□) Keep the Power Supply as far away from heating elements as possible when installing. As a reference value, allow at least 50 mm spacing on the right and left sides. If only 20 mm spacing is allowed, use the Power Supply at a load ratio of 80% or less.

S8VM-100□□□□/150□□□□

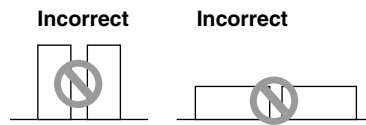

Wiring

Connect the ground completely. A protective earthing connection stipulated in safety standards is used. Electric shock or malfunction may occur if the ground is not connected completely.

Minor fire may possibly occur. Ensure that input and output terminals are wired correctly.

Do not apply more than 100 N force to the terminal block when tightening it.

Be sure to remove the sheet covering the Product for machining before power-ON so that it does not interfere with heat dissipation.

Use the following material for the wires to be connected to the S8VM to prevent smoking or ignition caused by abnormal loads. Over heating or fire can result from inadequately sized wiring materials when problems occur at the load. As a general rule, always select wire sizes suitable for at least 1.6 times the rated current.

Recommended Wire Types

Model		Recommended wire type
S8VM-015□□□□	(M3.5)	AWG24 to 14 (0.205 to 2.081 mm ²)
S8VM-030□□□□		
S8VM-050□□□□		
S8VM-100□□□□	(M3.5)	AWG24 to 14 (0.205 to 2.081 mm ²)
S8VM-150□□□□		
S8VM-100□□□□	(M4)	AWG24 to 12 (0.205 to 3.309 mm ²)
S8VM-150□□□□		

Selection of Wires

Select wires for the Power Supply carefully. Refer to this table when selecting the wires.

AWG No.	Cross-sectional area (mm ²)	Configuration (number of conductors/mm)	Voltage drop per 1 A (mV/meter)	Recommended maximum current (A)	
				UL1007 (300 V at 80° C)	UL1015 (600 V at 105° C)
30	0.051	7/0.102	358	0.12	---
28	0.081	7/0.127	222	0.15	0.2
26	0.129	7/0.16	140	0.35	0.5
24	0.205	11/0.16	88.9	0.7	1.0
22	0.326	17/0.16	57.5	1.4	2.0
20	0.517	26/0.16	37.6	2.8	4.0
18	0.823	43/0.16	22.8	4.2	6.0
16	1.309	54/0.18	14.9	5.6	8.0
14	2.081	41/0.26	9.5	---	12.0
12	3.309	65/0.26	6.0	---	22.0
10	5.262	104/0.26	3.8	---	35.0

Recommended Maximum Current

The table is applicable to wires with 1 to 4 conductors. Keep the current value to within 80% of the values shown in this table when using wires having 5 or more conductors.

XH Connector Preparation

The following Products are provided with the S8VM-05024A□/P□, S8VM-10024A□/P□ and S8VM-15024A□/P□ for the undervoltage alarm transistor output wiring.

Connector	S8VM-05024A□/P□	S8VM-10024A□/P□ S8VM-15024A□/P□	Manufactured by JST
	S3B-XH-A-1	BH3B-XH-2	
Housing (provided)	XHP-3		
Terminal (provided)	BXH-001T-P0.6 or SXH-001T-P0.6		

Be sure to prepare the connector according to the following instructions to ensure correct wiring. For details, refer to the JST catalog.

- Use a wire size of AWG22 to AWG28.
- The guideline for the length of sheath to be stripped from the wire is 2.1 to 2.6 mm.
- Use either a YC or YRS Crimping Tool (manufactured by JST) to crimp the terminal and wire.
- Be sure to insert the crimped terminal wires into the housing fully until a click is heard. Also, make sure that the wires attached to the housing are securely locked in place.

Installation Environment

Do not use the Power Supply in locations subject to shocks or vibrations. In particular, install the Power Supply as far away as possible from contactors or other devices that are a vibration source. Install the Power Supply well away from any sources of strong, high-frequency noise and surge.

Operating Life

The life of a Power Supply is determined by the life of the electrolytic capacitors used inside. Here, Arrhenius Law applies, i.e., the life will be halved for each rise of 10° C or the life will be doubled for each drop of 10° C. The life of the Power Supply can thus be increased by reducing its internal temperature.

Ambient Operating and Storage Environments

Store the Power Supply at a temperature of -25 to 65°C and a humidity of 25% to 90%.

The Internal parts may occasionally be deteriorated or damaged. Do not use the Power Supply outside the derating range (i.e., under conditions indicated by the shaded area () in the derating curve diagrams on page 7.)

Use the Power Supply at a humidity of 30% to 85%.

Do not use the Power Supply in locations subject to direct sunlight.

Do not use the Power Supply in locations where liquids, foreign matter, or corrosive gases may enter the interior of the product.

Overcurrent Protection

Internal parts may occasionally deteriorate or be damaged if a short-circuited or other overcurrent state continues during operation. Eliminate the overcurrent state as soon as possible.

Internal parts may possibly be deteriorated or damaged if the Power Supply is used for applications with frequent inrush current or overloading at the load end. Do not use the Power Supply for such applications.

Charging the Battery

If a battery is to be connected as the load, install an overcurrent limiting circuit and an overvoltage protection circuit.

Dielectric Strength Test

If a high voltage is applied between an input and the case (PE/FG), it will pass through the LC of the built-in noise filter and energy will be stored. If the high voltages used for dielectric strength testing are turned ON and OFF with a switch, timer, or similar device, impulse voltage will be generated when the voltage is turned OFF and internal parts may possibly be damaged. To prevent the generation of impulse voltages, reduce the applied voltage slowly with a variable resistor on the test device or turn the voltage ON and OFF at the zero-cross point.

When performing the test, be sure to short-circuit all the output terminals to protect them from damage.

Insulation Test

When performing the test, be sure to short-circuit all the output terminals to protect them from damage.

Inrush Current

When two or more Power Supplies are connected to the same input, inrush current is added to the total current. Select fuses and circuit breakers giving sufficient consideration to the fusing or operating characteristics so that fuses will not burn and breakers will not break due to inrush current.

Output Voltage Adjuster (V.ADJ)

Default Setting: Set at the rated voltage

Adjustable Range: Adjustable with output voltage adjuster (V.ADJ) on the front panel of the Product from -20% to 20% of the rated output voltage (-10% to 20% of the rated voltage for S8VM-□□□24A□/P□)

Turning clockwise increases the output voltage and turning counterclockwise decreases the output voltage.

The output voltage adjuster (V.ADJ) may possibly be damaged if it is turned with unnecessary force. Do not turn the adjuster with excessive force.

After completing output voltage adjustment, be sure that the output capacity or output current does not exceed the rated output capacity or rated output current.

The output voltage may increase beyond the allowable voltage range (up to +20% of the rated voltage) depending on the operation of the output voltage adjuster (V.ADJ). When adjusting the output voltage, check the output voltage of the Power Supply and be sure that the load is not damaged.

When increasing the output voltage to more than +20% of the rated value using the output voltage adjuster (V.ADJ), the overvoltage protection function may operate.

(S8VM-□□□24A□/P□ Only)

Turn the output voltage adjuster (V.ADJ) slowly. When decreasing the output voltage quickly, or when adjusting the output voltage to less than -10% of the rated value, the undervoltage alarm function may operate.

DIN Rail Mounting

When mounting to a DIN Rail, lower the S8VM onto the Rail until the Rail stopper clicks into place, hook section A over the edge of the Rail and push in the direction of B.

To remove the S8VM from the DIN Rail, insert a screwdriver into section C and pull the S8VM away from the Rail.

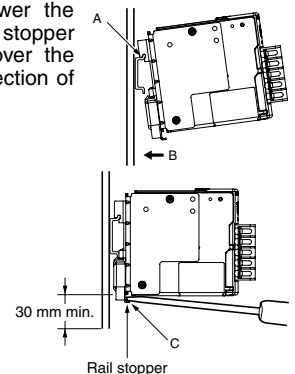

Series Operation

Two Power Supplies can be connected in series.
The (±) voltage output can be accomplished with two Power Supplies.

Series Operation

15W/30W
Correct

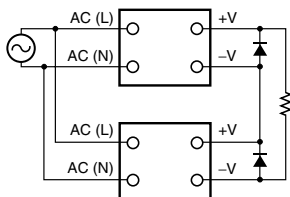

50W/100W/150W
Correct

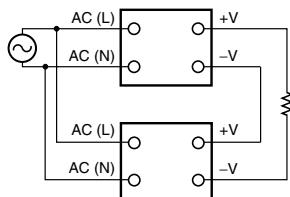

Output Voltage (±)

Correct

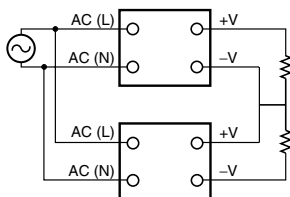

Note: 1. If the load is short-circuited, a reverse voltage may be applied inside the Power Supply unit, and this may possibly cause the deterioration or damage of the Power Supply unit. Connect the diode as shown in the figure. Use the following guidelines to select the diode to be connected.

Type	Schottky Barrier diode
Dielectric strength (VRRM)	Twice the rated output voltage or above
Forward current (IF)	Twice the rated output current or above

2. Though Products having different specifications can be connected in series, the current flowing through the load must not exceed the smaller rated output current.

Parallel Operation

The product is not designed for parallel operation.

Incorrect

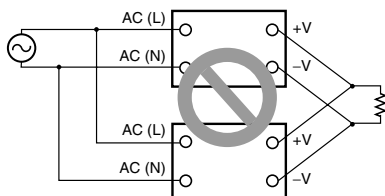

In Case There Is No Output Voltage

The possible cause for no output voltage may be that the overcurrent protection or overvoltage protection has operated. The internal protection circuit may operate if a large amount of surge voltage such as a lightning surge occurs while turning ON the input power.

If there is no output voltage even after checking the following points please contact us.

Check the Overload Protected Status

Check whether the load is in overload status or is short-circuited. Remove wires load when checking.

Attempt to Clear the Overvoltage or Internal Protection Function

Turn the input power OFF once, and leave it OFF for at least 3 minutes. Then turn it ON again to see if this clears the condition.

Check whether the +S terminal or -S terminal is opened with the short bar removed. (S8VM-100□□□□/ S8VM-150□□□□ only)

Check if the output voltage has been adjusted to more than +20% of the rated value by output voltage adjuster (V. ADJ).

Buzzing Noise when the Input Is

Turned ON

(50/100/150W)

A harmonic current suppression circuit is built into the input power. This circuit can create noise when the input is turned ON, but it will last only until internal operation stabilizes and does not indicate any problem in the Product.

Typical Values

■ For Reference Only

Item		Power ratings	15 W	30 W	50 W	100 W	150 W
Efficiency	5-V models		78%	81%	85%	87%	87%
	12-V models		81%	84%	84%	87%	87%
	15-V models		81%	84%	84%	87%	87%
	24-V models		82%	86%	84%	88%	88%
Input	Current	230 V input	0.20 A	0.39 A	0.31 A	0.61 A	5 V: 0.73 A 12 V/15 V/24 V: 0.83 A
	Leakage current	230 V input	0.30 mA	0.35 mA	0.35 mA	0.35 mA	0.35 mA
	Inrush current (See note 1.)	230 V input	28 A	32 A	32 A	32 A	32 A
Output	Ripple	f=20MHz measuring	5 V: 0.60% (p-p)	5 V: 0.60% (p-p)	5 V: 2.39% (p-p)	5 V: 2.10% (p-p)	5 V: 1.97% (p-p)
			12 V: 0.08% (p-p)	12 V: 0.14% (p-p)	12 V: 0.56% (p-p)	12 V: 0.69% (p-p)	12 V: 0.67% (p-p)
			15 V: 0.07% (p-p)	15 V: 0.12% (p-p)	15 V: 0.36% (p-p)	15 V: 0.60% (p-p)	15 V: 0.54% (p-p)
			24 V: 0.07% (p-p)	24 V: 0.12% (p-p)	24 V: 0.22% (p-p)	24 V: 0.27% (p-p)	24 V: 0.32% (p-p)
		f=100MHz measuring	5 V: 0.77% (p-p)	5 V: 0.88% (p-p)	5 V: 2.47% (p-p)	5 V: 2.42% (p-p)	5 V: 2.54% (p-p)
			12 V: 0.20% (p-p)	12 V: 0.20% (p-p)	12 V: 0.58% (p-p)	12 V: 0.78% (p-p)	12 V: 0.75% (p-p)
			15 V: 0.12% (p-p)	15 V: 0.18% (p-p)	15 V: 0.37% (p-p)	15 V: 0.68% (p-p)	15 V: 0.63% (p-p)
			24 V: 0.10% (p-p)	24 V: 0.18% (p-p)	24 V: 0.23% (p-p)	24 V: 0.31% (p-p)	24 V: 0.37% (p-p)
	Start up time (See note 1.)	at 100% load	270 ms	280 ms	460 ms	460 ms	460 ms
	Hole time (See note 1.)	at 100% load	5 V: 211 ms	5 V:187 ms	5 V: 43 ms	5 V: 40 ms	5 V: 41 ms
12 V: 213 ms			12 V:200 ms	12 V: 38 ms	12 V: 43 ms	12 V: 41 ms	
15 V: 221 ms			15 V:204 ms	15 V: 42 ms	15 V: 40 ms	15 V: 37 ms	
24 V: 216 ms			24 V:197 ms	24 V: 30 ms	24 V: 36 ms	24 V: 33 ms	

Note: 1. Refer to the *Engineering Data* section on page 7 to 8 for details.

2. The typical values indicate the values for an input condition of 230 VAC. All items are measured at a frequency of 50 Hz.

Warranty and Application Considerations

Read and Understand this Catalog

Please read and understand this catalog before purchasing the products. Please consult your OMRON representative if you have any questions or comments.

Warranty and Limitations of Liability

WARRANTY

OMRON's exclusive warranty is that the products are free from defects in materials and workmanship for a period of one year (or other period if specified) from date of sale by OMRON.

OMRON MAKES NO WARRANTY OR REPRESENTATION, EXPRESS OR IMPLIED, REGARDING NON-INFRINGEMENT, MERCHANTABILITY, OR FITNESS FOR PARTICULAR PURPOSE OF THE PRODUCTS. ANY BUYER OR USER ACKNOWLEDGES THAT THE BUYER OR USER ALONE HAS DETERMINED THAT THE PRODUCTS WILL SUITABLY MEET THE REQUIREMENTS OF THEIR INTENDED USE. OMRON DISCLAIMS ALL OTHER WARRANTIES, EXPRESS OR IMPLIED.

LIMITATIONS OF LIABILITY

OMRON SHALL NOT BE RESPONSIBLE FOR SPECIAL, INDIRECT, OR CONSEQUENTIAL DAMAGES, LOSS OF PROFITS, OR COMMERCIAL LOSS IN ANY WAY CONNECTED WITH THE PRODUCTS, WHETHER SUCH CLAIM IS BASED ON CONTRACT, WARRANTY, NEGLIGENCE, OR STRICT LIABILITY.

In no event shall the responsibility of OMRON for any act exceed the individual price of the product on which liability is asserted.

IN NO EVENT SHALL OMRON BE RESPONSIBLE FOR WARRANTY, REPAIR, OR OTHER CLAIMS REGARDING THE PRODUCTS UNLESS OMRON'S ANALYSIS CONFIRMS THAT THE PRODUCTS WERE PROPERLY HANDLED, STORED, INSTALLED, AND MAINTAINED AND NOT SUBJECT TO CONTAMINATION, ABUSE, MISUSE, OR INAPPROPRIATE MODIFICATION OR REPAIR.

Application Considerations

SUITABILITY FOR USE

OMRON shall not be responsible for conformity with any standards, codes, or regulations that apply to the combination of products in the customer's application or use of the products.

Take all necessary steps to determine the suitability of the product for the systems, machines, and equipment with which it will be used.

Know and observe all prohibitions of use applicable to this product.

NEVER USE THE PRODUCTS FOR AN APPLICATION INVOLVING SERIOUS RISK TO LIFE OR PROPERTY WITHOUT ENSURING THAT THE SYSTEM AS A WHOLE HAS BEEN DESIGNED TO ADDRESS THE RISKS, AND THAT THE OMRON PRODUCTS ARE PROPERLY RATED AND INSTALLED FOR THE INTENDED USE WITHIN THE OVERALL EQUIPMENT OR SYSTEM.

Disclaimers

PERFORMANCE DATA

Performance data given in this catalog is provided as a guide for the user in determining suitability and does not constitute a warranty. It may represent the result of OMRON's test conditions, and the users must correlate it to actual application requirements. Actual performance is subject to the OMRON *Warranty and Limitations of Liability*.

CHANGE IN SPECIFICATIONS

Product specifications and accessories may be changed at any time based on improvements and other reasons. Consult with your OMRON representative at any time to confirm actual specifications of purchased product.

DIMENSIONS AND WEIGHTS

Dimensions and weights are nominal and are not to be used for manufacturing purposes, even when tolerances are shown.

ALL DIMENSIONS SHOWN ARE IN MILLIMETERS.

To convert millimeters into inches, multiply by 0.03937. To convert grams into ounces, multiply by 0.03527.

Cat. No. T033-E2-02A **In the interest of product improvement, specifications are subject to change without notice.**

OMRON Corporation

Industrial Automation Company

Control Devices Division H.Q.

Power Electronics Department

Shiokoji Horikawa, Shimogyo-ku,

Kyoto, 600-8530 Japan

Tel: (81)75-344-7108/Fax: (81)75-344-7189

OMRON EUROPE B.V. Wegalaan 67-69, NL-2132 JD, Hoofddorp, The Netherlands. Tel: +31 (0) 23 568 13 00 Fax: +31 (0) 23 568 13 88 www.omron-industrial.com

Austria

Tel: +43 (0) 1 80 19 00
www.omron.at

Belgium

Tel: +32 (0) 2 466 24 80
www.omron.be

Czech Republic

Tel: +420 234 602 602
www.omron.cz

Denmark

Tel: +45 43 44 00 11
www.omron.dk

Finland

Tel: +358 (0) 207 464 200
www.omron.fi

France

Tel: +33 (0) 1 56 63 70 00
www.omron.fr

Germany

Tel: +49 (0) 2173 680 00
www.omron.de

Hungary

Tel: +36 (0) 1 399 30 50
www.omron.hu

Italy

Tel: +39 02 32 68 777
www.omron.it

Middle East & Africa

Tel: +31 (0) 23 568 11 00
www.omron-industrial.com

Netherlands

Tel: +31 (0) 23 568 11 00
www.omron.nl

Norway

Tel: +47 (0) 22 65 75 00
www.omron.no

Poland

Tel: +48 (0) 22 645 78 60
www.omron.pl

Portugal

Tel: +351 21 942 94 00
www.omron.pt

Russia

Tel: +7 495 745 26 64
www.omron.ru

Spain

Tel: +34 913 777 900
www.omron.es

Sweden

Tel: +46 (0) 8 632 35 00
www.omron.se

Switzerland

Tel: +41 (0) 41 748 13 13
www.omron.ch

Turkey

Tel: +90 (0) 216 474 00 40
www.omron.com.tr

United Kingdom

Tel: +44 (0) 870 752 08 61
www.omron.co.uk

Authorised Distributor:

Control Systems

- Programmable logic controllers • Human-machine interfaces • Remote I/O

Motion & Drives

- Motion controllers • Servo systems • Inverters

Control Components

- Temperature controllers • Power supplies • Timers • Counters • Programmable relays
- Digital panel indicators • Electromechanical relays • Monitoring products • Solid-state relays
- Limit switches • Pushbutton switches • Low voltage switch gear

Sensing & Safety

- Photoelectric sensors • Inductive sensors • Capacitive & pressure sensors • Cable connectors
- Displacement & width-measuring sensors • Vision systems • Safety networks • Safety sensors
- Safety units/relay units • Safety door/guard lock switches