



Control relay, 24 V DC, 8DI(2AI), 4DO relays, display

Part no. EASY512-DC-R
Article no. 274108

Delivery programme

Product range			Control relays easyRelay
Basic function			easy500
Description			Stand alone customized laser inscription or delivery with user program possible with EASY-COMBINATION-* product (article No. 2010781)
Inputs			
Digital input count			digital: 8 digital: 8; of which can be used as analog: 2
Digital			8
of which can be used as analog			2
Outputs			
Type			Relay
Quantity of outputs			Relays: 4
Outputs		Number	4
Additional features			
Display			with display, with keypad
Supply voltage			24 V DC
Software			EASY-SOFT-BASIC/-PRO

Technical data

General

Standards			EN 55011, EN 55022, IEC/EN 61000-4, IEC 60068-2-6, IEC 60068-2-27
Dimensions (W x H x D)		mm	71.5 x 90 x 58 (4 PE)
Weight		kg	0.2
Mounting			Top-hat rail IEC/EN 60715, 35 mm or screw fixing using fixing brackets ZB4-101-GF1 (accessories)

Terminal capacities

Solid		mm ²	0.2/4 (AWG 22 - 12)
Flexible with ferrule		mm ²	0.2/2.5 (AWG 22 - 12)
Standard screwdriver		mm	3.5 x 0.8
Max. tightening torque		Nm	0.6

Climatic environmental conditions

Operating ambient temperature		°C	In accordance with IEC 60068-2-1, -25 - +55
Condensation			Take appropriate measures to prevent condensation
LCD display (clearly legible)		°C	0 - 55
Storage	θ	°C	-40 - +70
relative humidity		%	in accordance with IEC 60068-2-30, IEC 60068-2-78 5 - 95
Air pressure (operation)		hPa	795 - 1080

Ambient conditions, mechanical

Protection type (IEC/EN 60529, EN50178, VBG 4)			IP20
Vibrations		Hz	In accordance with IEC 60068-2-6 constant amplitude 0.15 mm: 10 - 57 constant acceleration 2 g: 57 - 150
Mechanical shock resistance (IEC/EN 60068-2-27) semi-sinusoidal 15 g/11 ms		Impacts	18
Drop to IEC/EN 60068-2-31	Drop height	mm	50
Free fall, packaged (IEC/EN 60068-2-32)		m	1
Mounting position			Vertical or horizontal

Electromagnetic compatibility (EMC)

Overvoltage category/pollution degree			III/2
Electrostatic discharge (ESD)			

applied standard			according to IEC EN 61000-4-2
Air discharge		kV	8
Contact discharge		kV	6
Electromagnetic fields (RFI) to IEC EN 61000-4-3		V/m	10
Radio interference suppression			EN 55011 Class B, EN 55022 Class B
Burst		kV	according to IEC/EN 61000-4-4 Supply cables: 2 Signal cables: 2
power pulses (Surge)			according to IEC/EN 61000-4-5 1 kV (supply cables, symmetrical)
Immunity to line-conducted interference to (IEC/EN 61000-4-6)		V	10

Insulation resistance

Clearance in air and creepage distances			EN 50178, UL 508, CSA C22.2, No. 142
Insulation resistance			EN 50178



Repetition accuracy of timing relays

Accuracy of timing relays (of values)		%	± 1
Resolution			
Range "S"		ms	10
Range "M:S"		s	1
Range "H:M"		min	1







Retentive memory

Write cycles of the retentive memory			1000000 (10 ⁶)
--------------------------------------	--	--	----------------------------

Power supply

Rated operational voltage	U _e	V	24 DC (-15/+20%)
Permissible range	U _e		20.4 - 28.8 V DC
Residual ripple		%	 5
Input current			normally 80 mA at U _e
Voltage dips		ms	≤ I _n accordance with IEC 61131-2 ≤ 10
Fuse		A	 1A (T)
Power loss	P	W	Normally 2

Digital inputs 24 V DC

Number			8
Inputs can be used as analog inputs			2 (I7,I8)
Status Display			LCD-Display
Potential isolation			from power supply: no between digital inputs: no from the outputs: yes to interface/memory card: no
Rated operational voltage	U _e	V DC	24
Input voltage		V DC	Signal 0:  5 (I1 - I8) Signal 1:  15 (I1 - I6),  8 (I7, I8)
Input current at signal 1		mA	I1 - I6: 3.3 (at 24 V DC) I7, I8: 2.2 (at 24 V DC)
Deceleration time		ms	20 (0 -> 1/1 -> 0, Debounce ON) normally 0.25 (0 -> 1, Debounce OFF, I1 - I8)
Cable length		m	100 (unshielded)
Frequency counter			
Number			2 (I3, I4)
Counter frequency		kHz	 1
Pulse shape			Square
Pulse pause ratio			1:1
Cable length		m	 20 (screened)
Rapid counter inputs			
Number			2 (I1, I2)
Cable length		m	 20 (screened)
Counter frequency		kHz	< 1

Pulse shape			Square
Pulse pause ratio			1:1



Digital inputs 24 V DC

Status Display			LCD-Display
----------------	--	--	-------------

Analog inputs

Number			2 (I7, I8)
Potential isolation			from power supply: no between digital inputs: no from the outputs: yes to interface/memory card: no
Input type			DC voltage
Signal range			0-10 V DC
Resolution			0.01 V analog 0.01 V digital 10 Bit (value 0 - 1023)
Input impedance		kΩ	11.2
Accuracy of actual value			
Two EASY devices		%	± 3
Within a single device		%	± 2, (I7, I8, I11, I12) ± 0.12 V
Conversion time, analog/digital		ms	Input delay ON: 20; Input delay OFF: each cycle time
Input current		mA	< 1
Cable length		m	 30, screened

Relay outputs

Number			4
Outputs in groups of			1
Parallel switching of outputs for increased output			Not permissible
Protection of an output relay			Miniature circuit-breaker B16 or fuse 8 A (slow)
Potential isolation			from power supply: yes From the inputs: yes Safe isolation according to EN 50178: 300 V AC Basic isolation: 600 V AC
Lifespan, mechanical	Operations	x 10 ⁶	10
Contacts			
Conventional thermal current (10 A UL)		A	8
Recommended for load: 12 V AC/DC		mA	> 500
Short-circuit-proof cos φ = 1, characteristic B16 at 600 A		A	16
Short-circuit-proof cos φ = 0.5 to 0.7, characteristic B16 at 900 A		A	16
Rated impulse withstand voltage U _{imp} of contact coil		kV	6
Rated operational voltage	U _e	V AC	250
Rated insulation voltage	U _i	V AC	250
Safe isolation according to EN 50178		V AC	300 between coil and contact 300 between two contacts
Making capacity			
AC--15, 250 V AC, 3 A (600 ops./h)	Operations		300000
DC-13, L/R  150 ms, 24 V DC, 1 A (500 S/h)	Operations		200000
Breaking capacity			
AC-15, 250 V AC, 3 A (600 Ops./h)	Operations		300000
DC-13, L/R  150 ms, 24 V DC, 1 A (500 S/h)	Operations		200000
Filament bulb load			
1000 W at 230/240 V AC	Operations		25000
500 W at 115/120 V AC	Operations		25000
Fluorescent lamp load			
Fluorescent lamp load 10 x 58 W at 230/240 V AC			
With upstream electrical device	Operations		25000
Uncompensated	Operations		25000
Fluorescent lamp load 1 x 58 W at 230/240 V AC, conventional, compensated	Operations		25000
Switching frequency			
Mechanical operations		x 10 ⁶	10

Switching frequency	Hz	10
Resistive load/lamp load	Hz	2
Inductive load	Hz	0.5
UL/CSA		
Uninterrupted current at 240 V AC	A	10
Uninterrupted current at 24 V DC	A	8
AC		
Control Circuit Rating Codes (utilization category)		B 300 Light Pilot Duty
Max. rated operational voltage	V AC	300
max. thermal continuous current $\cos \varphi = 1$ at B 300	A	5
max. make/break $\cos \varphi \neq$ capacity 1 at B 300	VA	3600/360
DC		
Control Circuit Rating Codes (utilization category)		R 300 Light Pilot Duty
Max. rated operational voltage	V DC	300
Max. thermal uninterrupted current at R 300	A	1
Max. make/break capacity at R 300	VA	28/28

Supply voltage U_{Aux}

Power loss	P	W	2
------------	---	---	---

Data for design verification according to IEC/EN 61439

Technical data for design verification			
Rated operational current for specified heat dissipation	I_n	A	0
Heat dissipation per pole, current-dependent	P_{vid}	W	0
Equipment heat dissipation, current-dependent	P_{vid}	W	0
Static heat dissipation, non-current-dependent	P_{vs}	W	2
Heat dissipation capacity	P_{diss}	W	0
IEC/EN 61439 design verification			
10.2 Strength of materials and parts			
10.2.2 Corrosion resistance			
			Meets the product standard's requirements.
10.2.3.1 Verification of thermal stability of enclosures			
			Meets the product standard's requirements.
10.2.3.2 Verification of resistance of insulating materials to normal heat			
			Meets the product standard's requirements.
10.2.3.3 Verification of resistance of insulating materials to abnormal heat and fire due to internal electric effects			
			Meets the product standard's requirements.
10.2.4 Resistance to ultra-violet (UV) radiation			
			Meets the product standard's requirements.
10.2.5 Lifting			
			Does not apply, since the entire switchgear needs to be evaluated.
10.2.6 Mechanical impact			
			Does not apply, since the entire switchgear needs to be evaluated.
10.2.7 Inscriptions			
			Meets the product standard's requirements.
10.3 Degree of protection of ASSEMBLIES			
			Meets the product standard's requirements.
10.4 Clearances and creepage distances			
			Meets the product standard's requirements.
10.5 Protection against electric shock			
			Does not apply, since the entire switchgear needs to be evaluated.
10.6 Incorporation of switching devices and components			
			Does not apply, since the entire switchgear needs to be evaluated.
10.7 Internal electrical circuits and connections			
			Is the panel builder's responsibility.
10.8 Connections for external conductors			
			Is the panel builder's responsibility.
10.9 Insulation properties			
10.9.2 Power-frequency electric strength			
			Is the panel builder's responsibility.
10.9.3 Impulse withstand voltage			
			Is the panel builder's responsibility.
10.9.4 Testing of enclosures made of insulating material			
			Is the panel builder's responsibility.
10.10 Temperature rise			
			The panel builder is responsible for the temperature rise calculation. Eaton will provide heat dissipation data for the devices.
10.11 Short-circuit rating			
			Is the panel builder's responsibility.
10.12 Electromagnetic compatibility			
			Is the panel builder's responsibility.
10.13 Mechanical function			
			The device meets the requirements, provided the information in the instruction leaflet (IL) is observed.

Approvals

Product Standards		IEC/EN see Technical Data; UL 508; CSA C22.2 No. 142-M1987; CSA C22.2 No. 213-M1987; CE marking
-------------------	--	---

UL File No.	E135462
UL Category Control No.	NRAQ
CSA File No.	012528
CSA Class No.	2252-01 + 2258-02
North America Certification	UL listed, CSA certified
Degree of Protection	IEC: IP20, UL/CSA Type: -
shipping classification	BV DNV GL LR



Dimensions

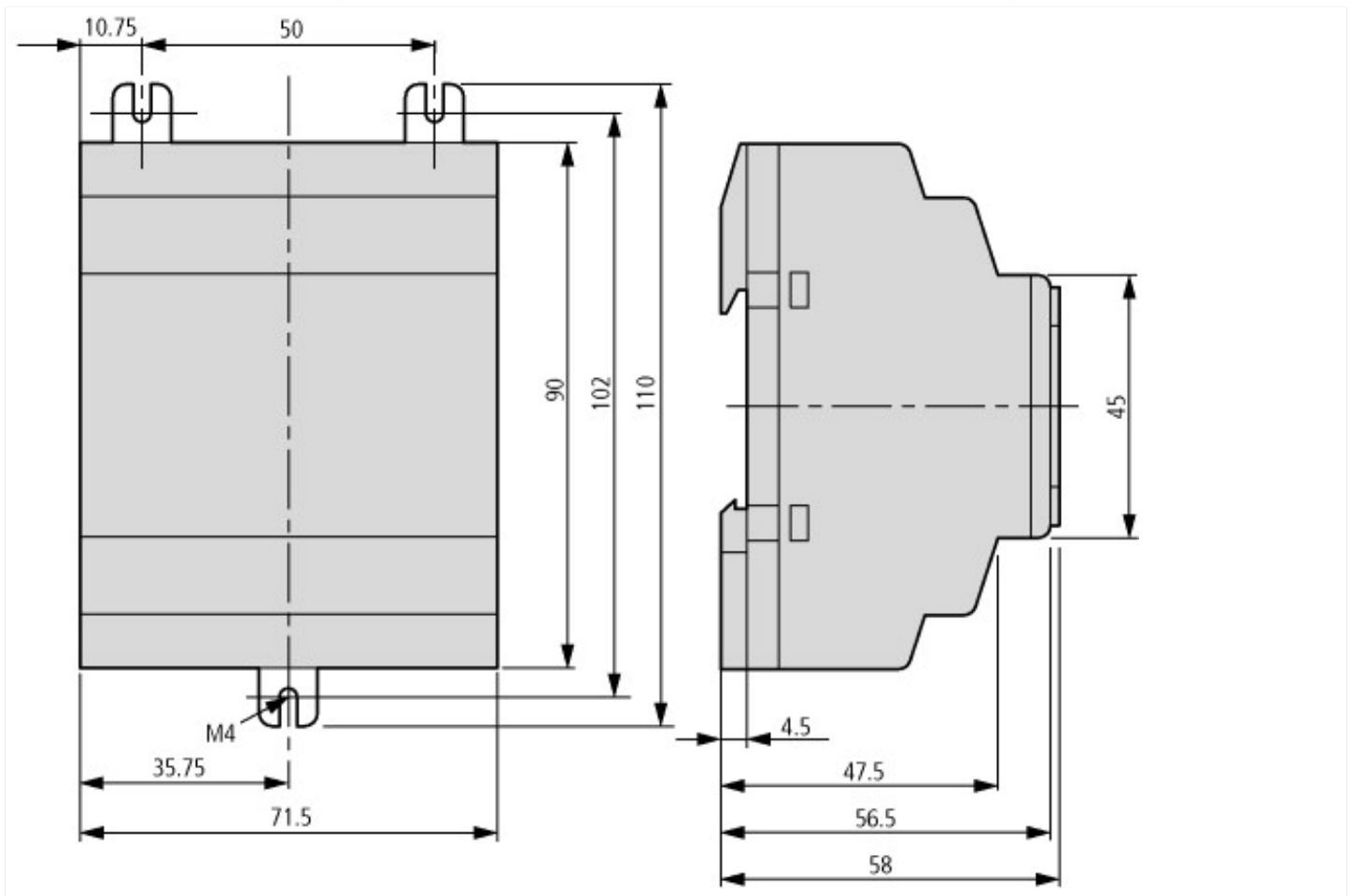

Additional product information (links)

IL05013015Z (AWA2528-2105) Control relay easy

IL05013015Z (AWA2528-2105) Control relay easy ftp://ftp.moeller.net/DOCUMENTATION/AWA_INSTRUCTIONS/IL05013015Z2010_11.pdf

MN05013003Z (AWB2528-1508) easy500, easy700 control relay

MN05013003Z (AWB2528-1508) Steuerrelais easy500, easy700 - Deutsch ftp://ftp.moeller.net/DOCUMENTATION/AWB_MANUALS/MN05013003Z_DE.pdf

MN05013003Z (AWB2528-1508) easy500, easy700 control relay - English ftp://ftp.moeller.net/DOCUMENTATION/AWB_MANUALS/MN05013003Z_EN.pdf

Labeleditor <http://downloadcenter.moeller.net/de/software.f6023a63-5acb-42c7-a51c-ccf99091cace>