

Price* : 23.06 GBP

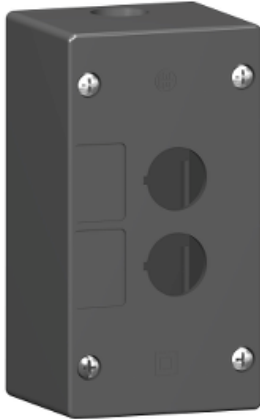

Main

Range of product	Harmony XALG
Product or component type	Empty control station
Device short name	XALG
Product destination	For XB5 Ø 22 mm control and signalling units
Environmental characteristic	Severe ambiance
Colour of base of enclosure	Black RAL 9005
Colour of cover	Black RAL 9005
Material	Mineral reinforced polyamide
Cable entry	2 knock-outs for ISO M20 cable entry
IP degree of protection	IP69 IP66 conforming to IEC 60529 IP67 conforming to IEC 60529 IP69K

Complementary

Assembly style	For customer assembly
Number of cut-out	2 cut-outs, vertical operator cut-out centre distance: 30 mm
CAD overall width	135 mm
CAD overall height	72 mm
CAD overall depth	65 mm
Product weight	0.28 kg
Resistance to high pressure washer	10 mPa at 80 °C, distance: 0.2 m

Environment

Protective treatment	TC TH
Ambient air temperature for storage	-40...70 °C
Ambient air temperature for operation	-25...70 °C
Electrical shock protection class	Class II conforming to EN/IEC 61140
IK degree of protection	IK05 conforming to EN 50102
Resistance to chemical agents	Good resistance to lactic acid at 10 °C Good resistant to detergent at 60 °C

Not resistant to formic acid (10 %) at 50 °C
Not resistant to lactic acid at 90 °C
Good resistance to ammonia
Good resistance to benzene
Good resistance to butter
Good resistance to citric acid (10 %)
Good resistance to cutting compounds
Good resistance to ethane
Good resistance to ethanol
Good resistance to ethylene
Good resistance to fatty acids
Good resistance to fatty alcohols
Good resistance to milk
Good resistance to motor oils and greases
Good resistance to oils (vegetable, mineral)
Good resistance to petroleum
Good resistant to acetone
Good resistant to uric acid (20 %)
Limited resistance to acetic acid (10 %)
Limited resistance to boric acid
Not resistant to hydrogen peroxide (30 %)
Not resistant to nitric acid (2 %)

Standards	EN/IEC 60947-1 EN/IEC 60947-5-1
-----------	------------------------------------

Contractual warranty

Warranty period	18 months
-----------------	-----------

Dimensions

mm
in.

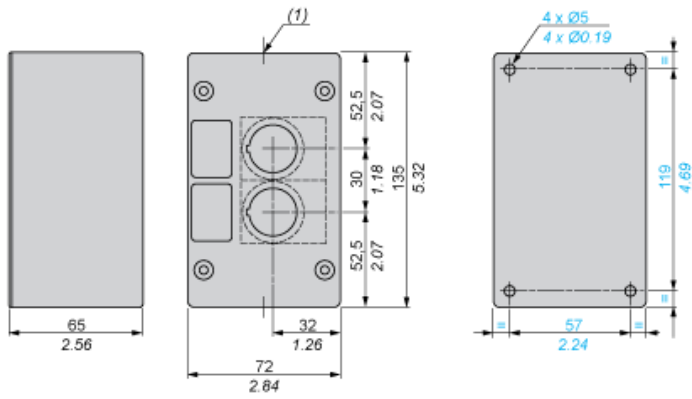

(1) 2 ISO 20 cable entries.