

## Cable - VIP-CAB-FLK14/16/8,0M/S7 - 2904523

Please be informed that the data shown in this PDF Document is generated from our Online Catalog. Please find the complete data in the user's documentation. Our General Terms of Use for Downloads are valid (<http://phoenixcontact.com/download>)



Unshielded round cable, for front adapters belonging to the Siemens SIMATIC® "TOP connect" range, with a 16-pos. and 14-pos. (encapsulated) socket strip, for connecting a maximum of 8 channels, cable length: 8.0 m



### Key commercial data

Packing unit	1 pc
GTIN	 4 046356 859295
Weight per Piece (excluding packing)	333.33 g
Custom tariff number	85444290
Country of origin	Germany
Note	Made to Order (non-returnable)

### Technical data

#### General

Nominal voltage U <sub>N</sub>	< 50 V AC
	60 V DC
Max. current carrying capacity per path	1 A
Max. conductor resistance	0.16 Ω/m
Length of cable	8 m
Single wire, cross section	0.14 mm <sup>2</sup>
AWG	26
Conductor construction: Number of litz wires:	7
Single wire, material	Cu tin-plated
External diameter	6.4 mm
Cable, preassembly	Insulation displacement, IEC 60352-4/DIN EN 60352-4
Shielding	no
Outer sheath, material	PVC
External sheath, color	Gray RAL 7035

#### Environmental conditions

# Cable - VIP-CAB-FLK14/16/8,0M/S7 - 2904523

## Technical data

### Environmental conditions

Ambient temperature (operation)	-20 °C ... 50 °C
Ambient temperature (storage/transport)	-20 °C ... 70 °C
Flame resistance	IEC 60332-1
Resistance to oil	UL 1581
Gasoline resistance	Against occasional splashes

### Connector, module side

Number of positions	14
Connectors	IDC/FLK socket strip (2.54 mm)
Number of plugs	1

### Connector, controller side

Number of positions	16
Connectors	IDC/FLK socket strip (2.54 mm)
Number of plugs	1

## Classifications

### eCl@ss

eCl@ss 4.0	27250315
eCl@ss 4.1	27250315
eCl@ss 5.0	27249290
eCl@ss 5.1	27242214
eCl@ss 6.0	27249205
eCl@ss 7.0	27249205
eCl@ss 8.0	27249205

### ETIM

ETIM 3.0	EC000830
ETIM 4.0	EC000237
ETIM 5.0	EC000237

### UNSPSC

UNSPSC 6.01	26121620
UNSPSC 7.0901	26121620
UNSPSC 11	26121620
UNSPSC 12.01	26121620
UNSPSC 13.2	26121620

## Approvals

### Approvals

# Cable - VIP-CAB-FLK14/16/8,0M/S7 - 2904523

## Approvals

Approvals

UL Recognized / cUL Recognized / EAC / cULus Recognized

Ex Approvals

Approvals submitted

## Approval details

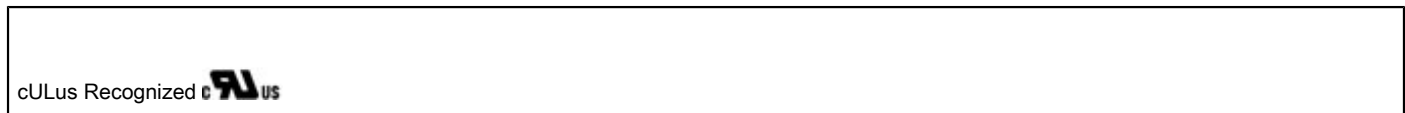

## Drawings

Connection diagram

14-pos. Socket strip PIN	16-pos. Socket strip PIN	Wire color
1	16	Black
2	14	Brown
3	12	Red
4	10	Orange
5	8	Yellow
6	6	Green
7	4	Blue
8	2	Violet
9	9	Gray
10	1	White
11	11	White-black
12	3	White-brown
13	13	White-red
14	5	White-orange
	7	-
	15	-

Dimensioned drawing

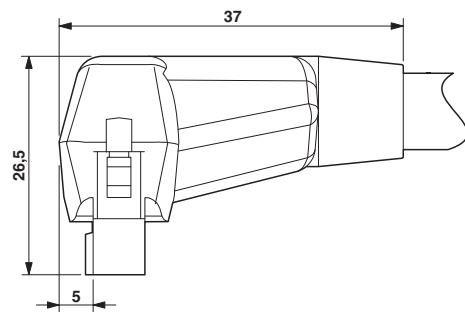

Pin assignment and color code

