

Deep groove ball bearings, single row

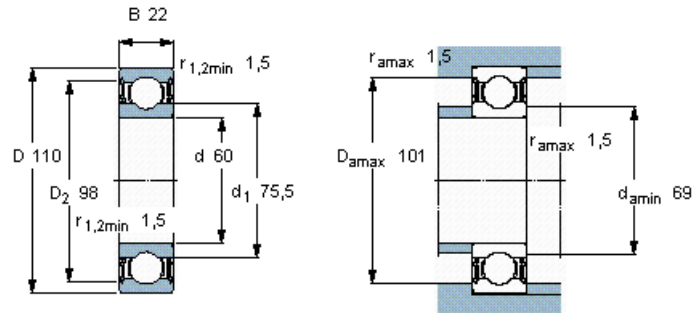

Principal dimensions			Basic load ratings		Fatigue load limit P_u	Speed ratings		Mass	Designation
d	D	B	dynamic	static		Reference speed	Limiting speed		
mm			kN	C_0	kN	r/min		kg	-
60	110	22	55,3	36	1,53	-	4000	0,78	6212-2RS1 *



Calculation factors

k_r 0,025

f_0 14