

ADDER Link X SERIES

INSTALLATION & USE

- | | |
|---------------|---|
| X-KVM/P | X-KVM extender pair |
| X-KVM/R | X-KVM receiver only |
| X-KVM/T | X-KVM transmitter only |
| X-SC | Skew compensation unit |
| X-RMK-CHASSIS | Rack mount chassis for X-Series products |
| X-PDM4 | Rack mountable power distribution module |
| X-RMK-KVM/R | Rack mount securing plate for receiver |
| X-RMK-KVM/T | Rack mount securing plate for transmitter |
| X-RMK-SC | Rack securing plate for skew compensator |
| X-RMK-BLANK | Rack mount single slot blanking plate |
| X-RMK-BLANK4 | Rack mount quad slot blanking plate |



The AdderLink contains fine video compensation amplifiers to maximise the video quality for any given length of twisted pair cable. To adjust the compensation and sharpen the video picture refer to section 2.7



www.adder.com

ADDER Link X

About this manual

AdderLink X-Series - Installation and Use

www.addertec.com

First edition (May 2002)

Part No. ADD0044/1

(c) 2002 Adder Technology Ltd.

All rights reserved. Whilst every precaution has been taken in the preparation of this manual, Adder Technology Ltd assumes no responsibility for errors or omissions. Neither is any liability assumed for damages resulting from the use of the information contained herein. We reserve the right to change the specifications, functions and circuitry of the product without notice.

Safety information

- For use in dry, oil free indoor environments only.
- Warning - live parts contained within power adapter.
- No user serviceable parts within power adapter - do not dismantle.
- Plug the power adapter into a socket outlet close to the AdderLink unit that it is powering.
- Replace the power adapter with a manufacturer approved type only.
- Do not use the power adapter if the power adapter case becomes damaged, cracked or broken or if you suspect that it is not operating properly.
- If you use a power extension cord with the AdderLink, make sure the total ampere rating of the devices plugged into the extension cord does not exceed the cord's ampere rating. Also, make sure that the total ampere rating of all the devices plugged into the wall outlet does not exceed the wall outlet's ampere rating.
- Do not attempt to service the AdderLink yourself.

Warranty

Adder Technology Ltd warrants that this product shall be free from defects in workmanship and materials for a period of two years from the date of original purchase. If the product should fail to operate correctly in normal use during the warranty period, Adder will replace or repair it free of charge. No liability can be accepted for damage due to misuse or circumstances outside Adder's control. Also Adder will not be responsible for any loss, damage or injury arising directly or indirectly from the use of this product. Adder's total liability under the terms of this warranty shall in all circumstances be limited to the replacement value of this product.

If any difficulty is experienced in the installation or use of this product that you are unable to resolve, please contact your supplier.

Trademarks

All trademarks mentioned in this manual are acknowledged to be the property of the respective trademark owners.

Adder is a registered trademark of Adder Technology Limited.

Compaq is a registered trademark of Compaq Computer Corporation.

Hewlett-Packard is a registered trademark of Hewlett-Packard.

IBM, PC/AT, PS/2, RS/6000 and ThinkPad are registered trademarks of International Business Machines Corporation.

Logitech, MouseMan+ and Pilot Mouse+ are trademarks of Logitech Inc.

Microsoft and Windows are registered trademarks, and IntelliMouse is a trademark of Microsoft Corporation.

Velcro is a trademark of Velcro USA Inc.

Radio Frequency Energy

A Category 5 (or better) twisted pair cable must be used to connect the AdderLink units in order to maintain compliance with radio frequency energy emission regulations and ensure a suitably high level of immunity to electromagnetic disturbances.

All other interface cables used with this equipment must be shielded in order to maintain compliance with radio frequency energy emission regulations and ensure a suitably high level of immunity to electromagnetic disturbances.

European EMC directive 89/336/EEC

This equipment has been tested and found to comply with the limits for a class A computing device in accordance with the specifications in the European standard EN55022. These limits are designed to provide reasonable protection against harmful interference. This equipment generates, uses and can radiate radio frequency energy and if not installed and used in accordance with the instructions may cause harmful interference to radio or television reception. However, there is no guarantee that harmful interference will not occur in a particular installation. If this equipment does cause interference to radio or television reception, which can be determined by turning the equipment on and off, the user is encouraged to correct the interference with one or more of the following measures: (a) Reorient or relocate the receiving antenna. (b) Increase the separation between the equipment and the receiver. (c) Connect the equipment to an outlet on a circuit different from that to which the receiver is connected. (d) Consult the supplier or an experienced radio / TV technician for help.



FCC Compliance Statement (United States)

This equipment generates, uses and can radiate radio frequency energy and if not installed and used properly, that is, in strict accordance with the manufacturer's instructions, may cause interference to radio communication. It has been tested and found to comply with the limits for a class A computing device in accordance with the specifications in Subpart J of part 15 of FCC rules, which are designed to provide reasonable protection against such interference when the equipment is operated in a commercial environment. Operation of this equipment in a residential area may cause interference, in which case the user at his own expense will be required to take whatever measures may be necessary to correct the interference. Changes or modifications not expressly approved by the manufacturer could void the user's authority to operate the equipment.

Canadian Department of Communications RFI statement

This equipment does not exceed the class A limits for radio noise emissions from digital apparatus set out in the radio interference regulations of the Canadian Department of Communications.

Le présent appareil numérique n'émet pas de bruits radioélectriques dépassant les limites applicables aux appareils numériques de la classe A prescrites dans le règlement sur le brouillage radioélectriques publié par le ministère des Communications du Canada.

Contents

1. Introduction.....	6
1.1 AdderLink X-KVM features.....	6
1.2 Product information.....	8
1.3 Package contents.....	11
2. Installation of the X-KVM extender	13
2.1 What you will need	13
2.2 Mounting the X-KVM	14
2.3 Connecting your devices	14
2.4 Configuring your PC.....	17
2.5 Configuring the X-KVM	17
2.6 Setting the option switches	18
2.7 Setting the video compensation manually	22
2.8 Performing special functions and setting user configurable options	24
2.9 Summary of X-KVM functions and options	25
2.10 Other useful installation information	27
2.11 Hot plugging the X-KVM into running systems and re-enabling disconnected PS/2 CPU mouse connections	27
2.12 Using the X-KVM/R with Adder SmartView XPro KVM switches	29
3. Rack mounting X-Series products in the 19 inch rack mount chassis.....	30
3.1 Mounting X-Series modules into the rack mount chassis	30
3.2 Installing and using the rack mountable power distribution module.....	31
3.3 Blanking plates for the 19 inch rack mount chassis	32

4. Using the X-KVM extender	33
4.1 Power on status	33
4.2 AdderLink indicator lights.....	33
4.3 Keyboard NUM,CAPS and SCROLL lock indicators.....	34
4.4 Keyboard hotkey control	35
4.5 Entering an exiting video compensation / configuration mode	36
4.6 Setting and using the security password	37
4.7 Querying the AdderLink's firmware version	38
5. X-KVM configuration options	40
5.1 Resetting all configuration options to their default state	40
5.2 Setting a mouse signalling protocol	40
6. Configuring and using the skew compensator	41
6.1 What is the skew compensator and why is it needed?	41
6.2 Can I predict if a skew compensator will be needed?.....	41
6.3 Correcting colour split	42
6.4 Reporting the cable skew and configuring the skew compensator	44
6.5 Setting up the skew compensator manually	45
7. Upgrading the X-KVM's flash memory	48

Appendices

A - Cable and connector specifications	51
--	----

1. Introduction

Thank you for purchasing the AdderLink X-Series KVM extender. Your AdderLink is designed to transfer keyboard, video, and mouse signals up to 200 metres over Category 5 (or higher specification) twisted pair cable. The AdderLink X-Series KVM extender consists of a transmitter (*local*) and a receiver (*remote*) unit that are connected together by a twisted pair cable. The *remote* unit connects to your keyboard, monitor and mouse and the *local* unit connects to the computer system that is to be controlled.

The optional X-Series skew compensator, rack mount chassis and power distribution module may be used together with your X-Series KVM extender.

Throughout this document, the AdderLink X-Series KVM extender is commonly abbreviated to X-KVM.

1.1 AdderLink X-KVM features

- Enables a keyboard, monitor, and mouse to be located up to 200 metres from a computer or KVM switch.
- Uses a single Category 5 (or better) twisted pair cable to carry all the keyboard, video and mouse signals.
- The X-KVM product is part of a family of complimentary extender products that are designed to meet a wide range of KVM extension requirements.
- Supports high bandwidth monitors at resolutions up to 1600 x 1280.
- Includes CPU connection cable for easy installation.
- Both ends of the X-KVM may be neatly rack mounted in the X-Series 19-inch rack mount chassis. Other X-Series products may also be mounted in this chassis. Each 2U high chassis will house up to 16 *local* or *remote* modules.
- Supports Microsoft IntelliMouse, IntelliMouse Explorer and other common wheel mice.

- Fine user-adjustable video compensation enables the video quality to be maximised for any given length of cable. Supports automatic and manual video compensation (compensation mode selectable by option switch).
- In manual compensation mode, the video compensation only needs to be adjusted once during setup. The chosen compensation setting is retained in EEPROM memory even when the X-KVM is powered off.
- In automatic compensation mode, the video compensation will be automatically adjusted every time that the X-KVM is powered on or reset.
- An optional X-Series skew compensator unit is available to compensate for the colour skew that is introduced by using longer lengths of certain types of Category 5e and 6 cable. The X-KVM reports the cable skew present in your installation and (optionally) the required skew compensation settings.
- Mixed AT/PS2 keyboards and PS2/RS232 mice supported as standard.
- Keyboard data is kept in its native format ensuring the additional keys on enhanced keyboards are supported.
- Password security prevents unauthorised use.
- Supports keyboard modes 1,2 and 3 and mouse prompt and stream modes for maximum compatibility.
- Flash upgradeable via the keyboard ports.
- The X-KVM **remote** unit is compatible with the Adder SmartView XPro extender ports.
- Power / activity indication confirm correct operation.
- Robust metal case ensures good shielding and video quality.
- 19 inch rack mount kit available.
- Supports IBM PC compatibles, Alpha, SGI and RS6000 computers.
- “Transparent” mode enables extender to be used to link together most cascaded KVM switch systems.
- Uses patent pending technology.

1.2 Product information

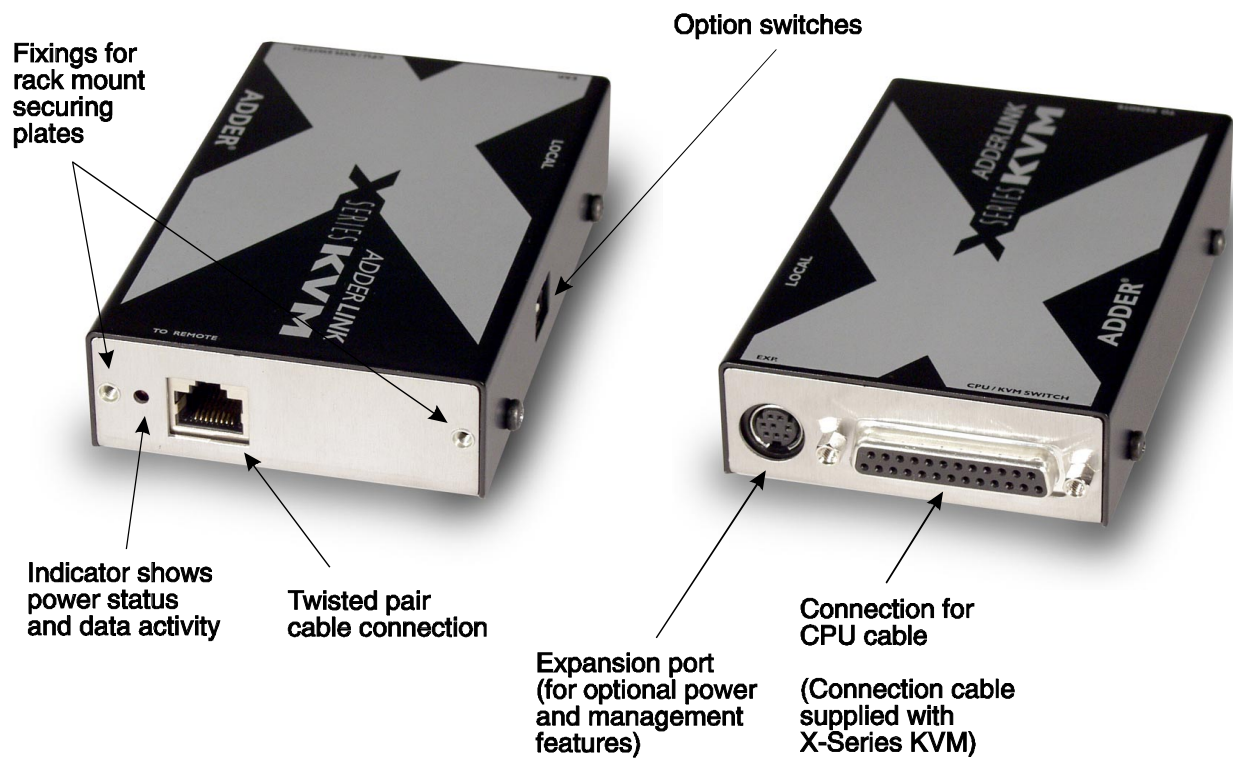

Figure 1 – AdderLink X-Series KVM *local* transmitter

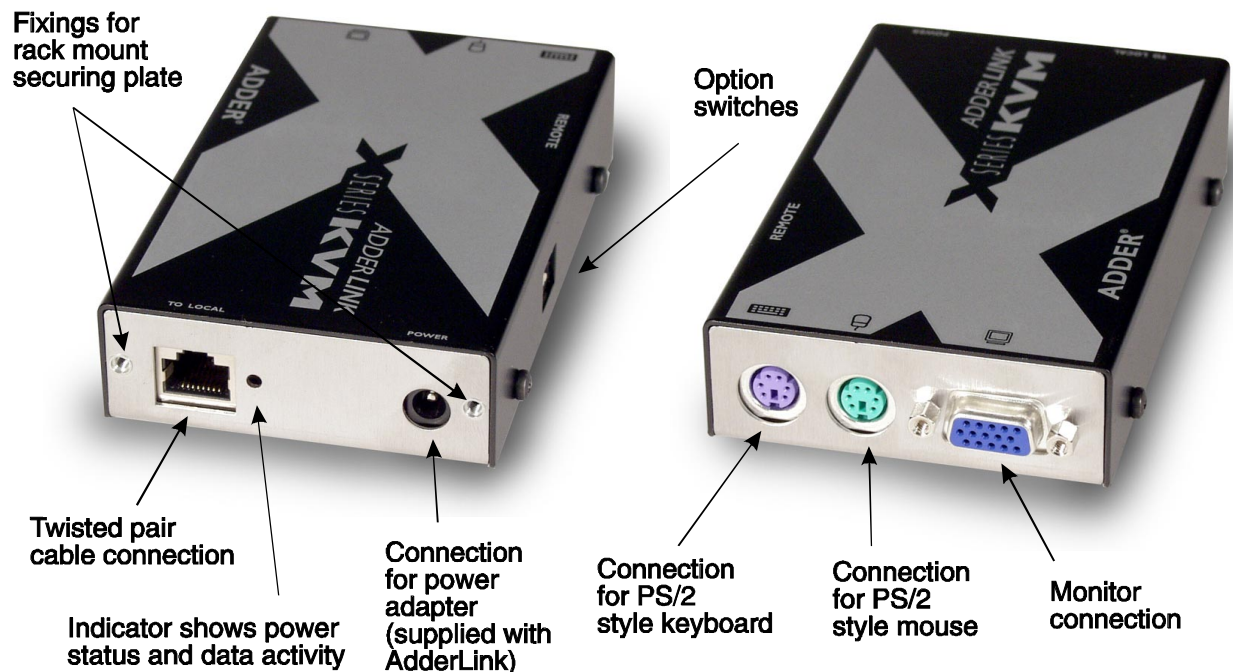

Figure 2 – AdderLink X-Series KVM *remote* receiver

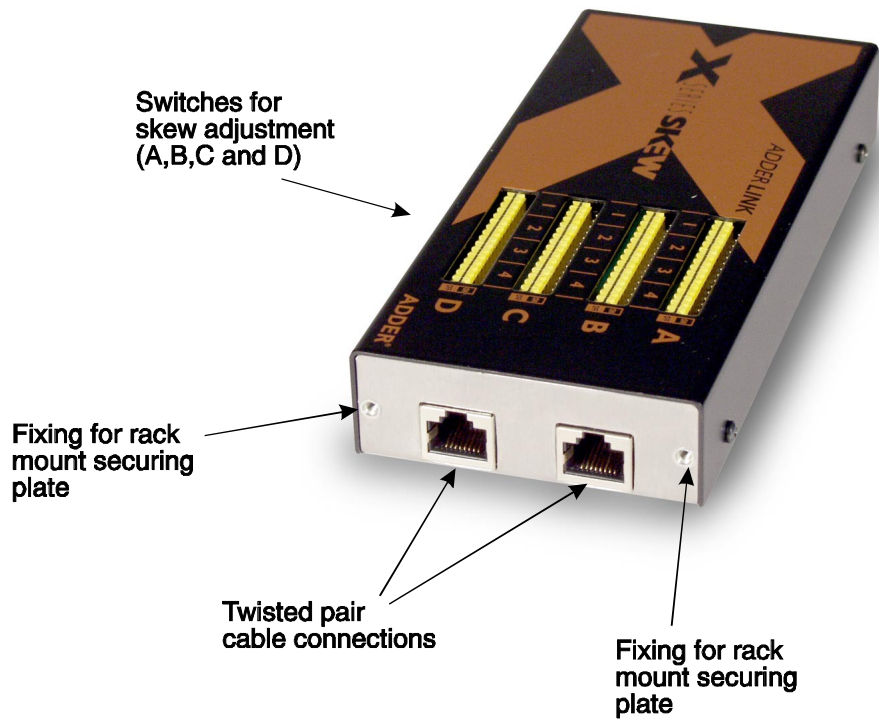

Figure 3 – AdderLink X-Series skew compensator (optional)

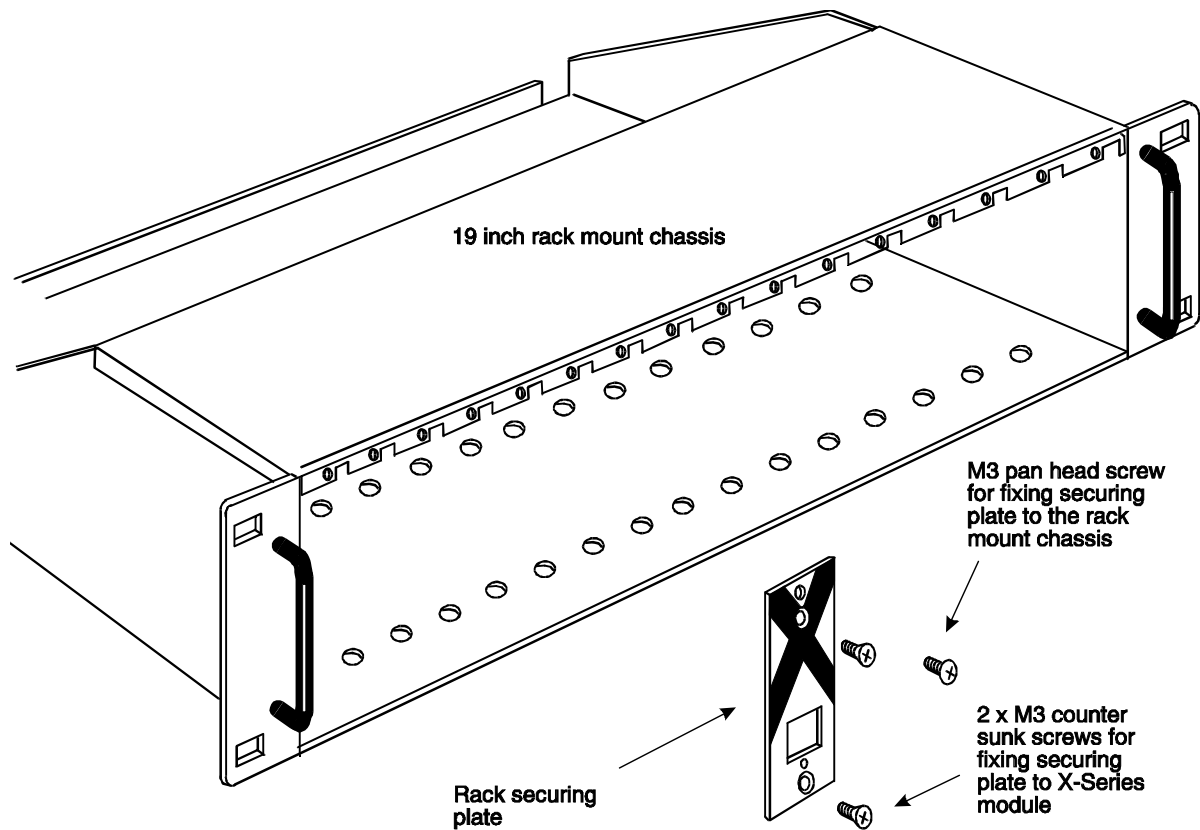

Figure 4 – AdderLink X-Series rack mount chassis and securing plates (optional)

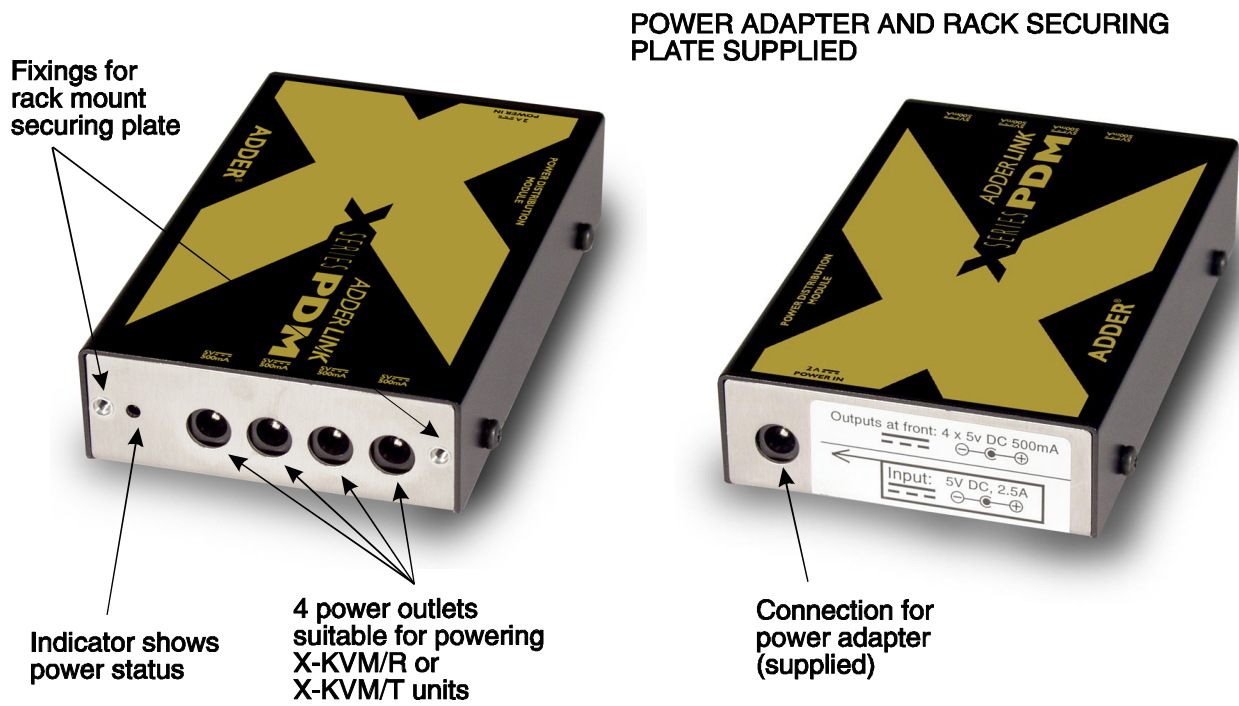

Figure 5 – AdderLink X-Series power distribution module (part code X-PDM4)

1.3 Package contents

AdderLink X-Series KVM package contents (part code: X-KVM/P)

Quantity	Description
1	AdderLink <i>local</i> transmitter unit
1	AdderLink <i>remote</i> receiver unit
1	Instruction manual
1	Power adapter for the <i>remote</i> receiver unit
1	Cable to connect the <i>local</i> unit to a computer or KVM switch
8	Self-adhesive rubber feet

AdderLink X-Series KVM *remote* receiver package contents (part code: X-KVM/R)

Quantity	Description
1	AdderLink <i>remote</i> receiver unit
1	Instruction manual
1	Power adapter for the <i>remote</i> receiver unit
4	Self-adhesive rubber feet

AdderLink X-Series KVM *local* transmitter package contents (part code: X-KVM/T)

Quantity	Description
1	AdderLink <i>local</i> transmitter unit
1	Instruction manual
1	Cable to connect the <i>local</i> unit to a computer or KVM switch
4	Self adhesive rubber feet

AdderLink X-Series skew compensation unit package contents (part code: X-SC)

Quantity	Description
1	AdderLink skew compensator unit
1	Instruction manual
4	Self-adhesive rubber feet

AdderLink X-Series rack mount chassis (part code X-RMK-CHASSIS)

Quantity	Description
1	Rack mount chassis
1	Instruction manual

AdderLink X-Series rack mount securing and blanking plates (Part codes starting: X-RMK-)

Quantity	Description
1	Rack mount securing plate
2	Counter-sunk screws for fixing the plate to the X-Series module
1	Pan head screw for fixing the plate to the rack mount chassis

AdderLink X-Series rack mountable power distribution module package contents (Part code X-PDM4)

Quantity	Description
1	Power distribution module
1	Power adapter (5V, 2.5A)
4	Short patch cables
1	Instruction manual
1	Rack mount securing plate for power distribution module
2	Counter-sunk screws for fixing the plate to the PDM module
1	Pan head screw for fixing the plate to the rack mount chassis

2. Installation of the X-KVM extender

2.1 What you will need

- A category 5 (or better) twisted pair cable of the required length to connect the X-KVM *local* and *remote* units together. These cables contain 4 pairs of twisted wires. Specifications and recommended cable types are given in appendix A. AdderLink X-KVM supports cable lengths up to 200 metres. Structured wiring within buildings may also be used together with suitable patch cables but the number of cable connections should be kept to a minimum to maximise signal quality.
- Cables to connect the X-KVM *local* unit to your computer. A two metre connection cable is provided with the X-KVM. Longer cables may be purchased separately or the two metre cable may be extended using standard KVM extension cables. Cable specifications are given in appendix A.
- A monitor with a standard VGA/SVGA (15 pin) connector that will work when connected directly to your computer. X-KVM supports low and high resolution monitors.
- A standard AT or PS/2 style keyboard. If you are using an AT keyboard with a 5 pin connector you may connect this to the X-KVM using a standard AT to PS/2 keyboard adapter.
- A PS/2 style two or three button Microsoft or Logitech compatible mouse or a Microsoft IntelliMouse compatible mouse.

(The X-KVM supports 'Internet Mice' that are compatible with the Microsoft IntelliMouse. These are fitted with a wheel or other scroll control and sometimes have additional buttons. Examples are: Microsoft IntelliMouse, Logitech Pilot Mouse+, Logitech MouseMan+, Genius NetMouse and Genius NetMouse Pro.)

- A suitable mouse driver for your PC(s). Supported types are:
 - PS/2 or RS232 two button mouse driver (any manufacturer).
 - Microsoft mouse driver (including IntelliMouse).
 - Logitech mouse driver (including two button, three button and wheel mouse)

Use of PS/2 and RS232 style mice with the X-KVM - The mouse connections from

AdderLink to PCs support either a PS/2 or an RS232 mouse. X-KVM automatically converts from the PS/2 mouse commands to RS232 serial mouse commands. Serial mice types are selected by using an adapter as described in Appendix A. The X-KVM will operate without a mouse connected if you do not wish to use one.

2.2 Mounting the X-KVM

The X-KVM has been designed to be used either on a desktop or mounted in a 19 inch rack. If you wish to use the X-KVM on a desktop then you will need to stick the self-adhesive rubber feet onto the underside of each X-KVM module (one is supplied for each corner).

If the X-KVM is to be mounted in a 19 inch rack then you will need the optional X-Series rack mounting chassis (part code: X-RMK-CHASSIS) and a rack securing plate for each local or remote module that you wish to rack mount. Part codes for these securing plates are:

Rack securing plate for X-KVM local module:	X-RMK-KVM/T
Rack securing plate for X-KVM remote module:	X-RMK-KVM/R

The X-KVM may also be mounted on a suitable vertical surface, such as the side of a desk, with the use of strong Velcro strips.

2.3 Connecting your devices

Ensure that the power adapter is disconnected from the X-KVM and that all the devices which are to be attached are switched off. Connect your devices to the X-KVM as shown in figure 6. Ensure that the cables are no longer than the maximum cable lengths specified in appendix A. Any unused computer or peripheral connections can be left unconnected. To connect computers with serial mouse connections and AT style keyboard connections you will need to purchase adapters. Please refer to appendix A for cable specifications.

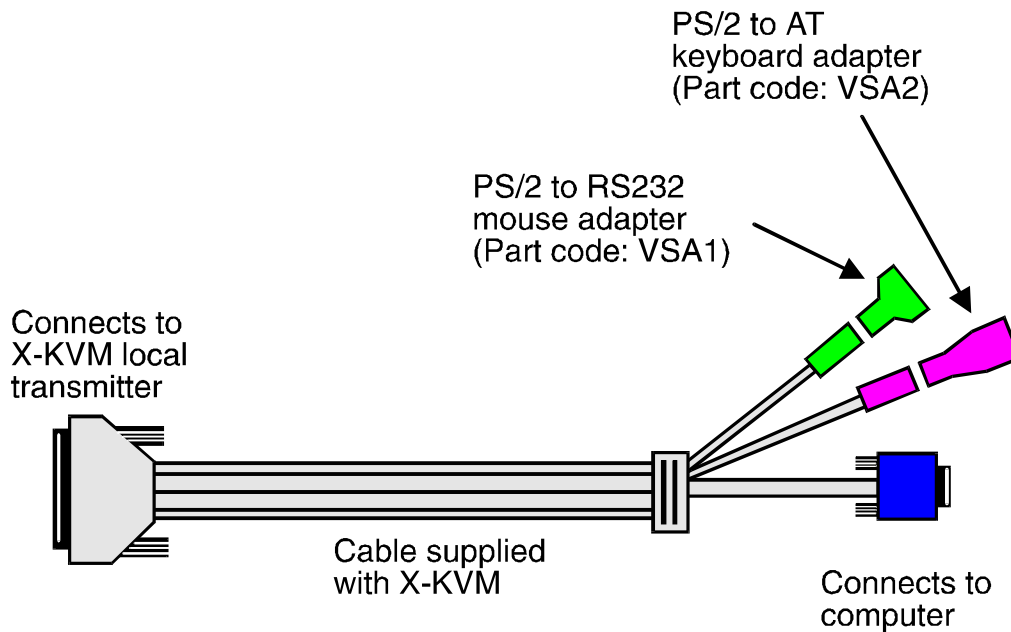

The X-KVM is now ready for use and will start to operate as soon the **local** and **remote** units are both powered on. There is no requirement to switch the X-KVM units on in any defined order. The X-KVM **local** unit draws its power from the connected computer via the keyboard cable. However, if you are connecting to a computer using cables that are longer than 5 metres or are connecting to a lower powered device, such as some types of keyboard/video/mouse switch, an optional power adapter may be required. When using the optional power adapter, ensure that it is connected to the mains and powering the X-KVM before you switch on the connected computers. Under these circumstances, failure to switch the X-KVM and computers on in the correct order can lead to the mouse and/or keyboard not being recognised by the computers when they are switched on.

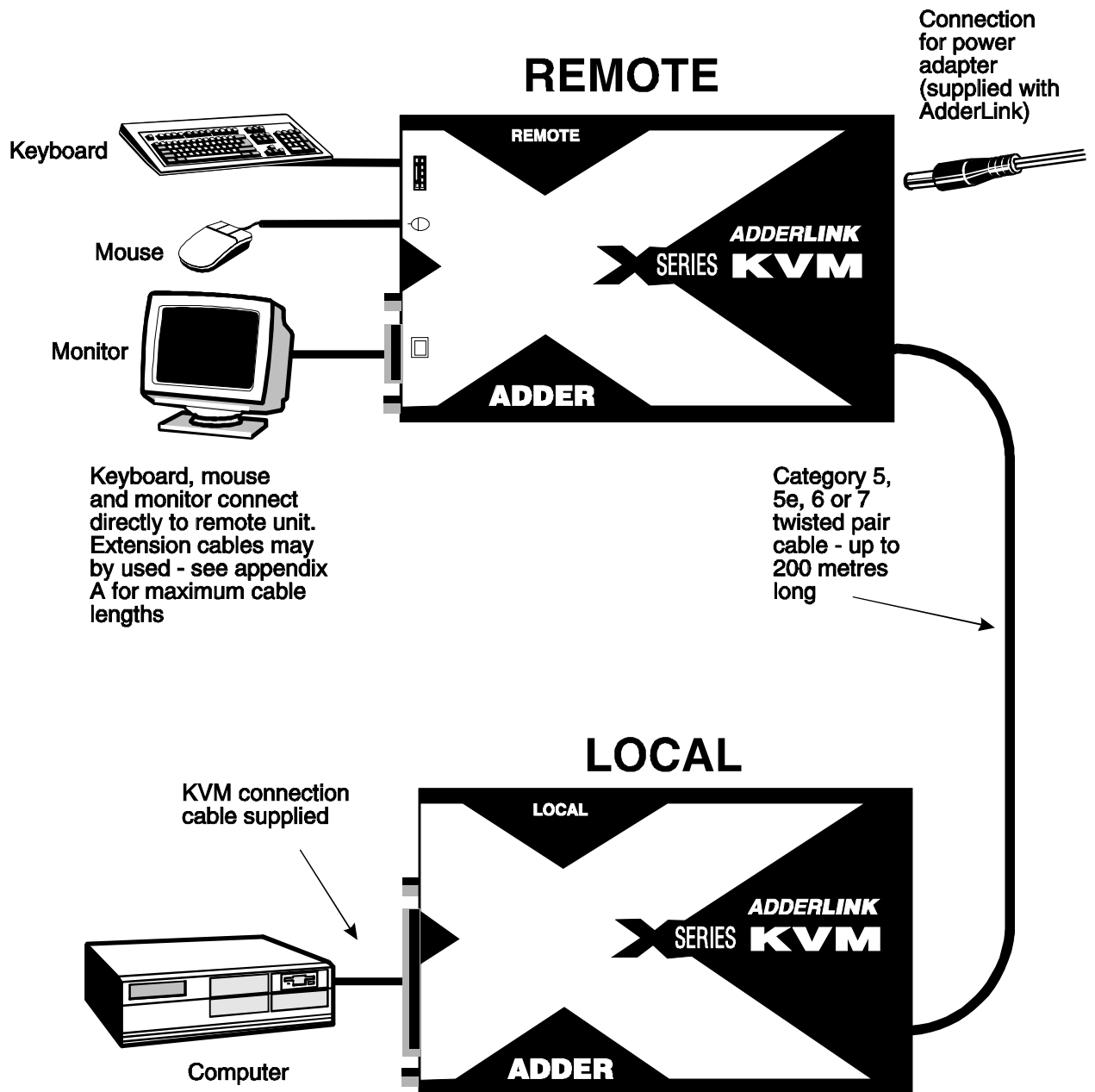

Figure 6 – A typical X-KVM extender application

2.4 Configuring your PC(s)

Configure your PC in the same way that you would if your keyboard, mouse, speakers, microphone and monitor were all connected directly to your PC, but bearing in mind the following points:

- X-KVM emulates Microsoft compatible serial, IntelliMouse and PS/2 mice, so ensure that your PC software is configured for a Microsoft mouse of the correct type. Refer to the list of supported drivers in section 2.1.
- X-KVM supports VGA/SVGA/XGA/XGA2 type monitors, but does not support the automatic detection features available with some 'plug and play' monitors and video cards. If you have this type of video card and monitor, you should select the video mode manually instead of relying upon the automatic detection feature.

2.5 Configuring the X-KVM

The X-KVM is supplied in a default state that is suitable for most applications. By default, the automatic compensation mode is selected. In this mode the video compensation amplifiers will be automatically adjusted to suit the twisted pair cable whenever the X-KVM is switched on. Some users may wish to manually fine tune the video compensation because the perfect adjustment for any given length of cable is subjective and depends upon personal preference. If manual compensation is selected then the video only needs to be compensated once during setup as the compensation value is stored by the X-KVM and retained even when the power is off.

The AdderLink X-KVM is configured using the following:

1. Option switches (see section 2.6)

The option switches on the side of the X-KVM select automatic or manual video compensation mode and the keyboard hotkey combination that is used to access video compensation / configuration mode. They also control some other hardware related functions.

2. Video compensation / configuration mode (see section 2.7)

This mode is entered by typing the hotkey combination (selected using the option switches) on the keyboard attached to the **remote** receiver. Once within video compensation / configuration mode you can adjust the video compensation and select other options using the keyboard. The selected options are saved and stored in the **remote** unit when you exit compensation / configuration mode.

2.6 Setting the option switches

The option switches on the side of the X-KVM **remote** and **local** units are used to select operating options. The switches are continuously read by the X-KVM and may be changed whilst the X-KVM is powered on. The default setting (all switches OFF) is suitable for most installations. The switches are shown in figures 7 and 8 and have the following functions.

REMOTE unit – Switch 1

Set this switch to the OFF position for normal operation. This switch is used to set the X-KVM **remote** unit into upgrade mode so that new firmware can be downloaded into its flash program memory.

REMOTE unit - Switches 2 and 3

These switches select the hotkey combinations that are recognised by the X-KVM. The chosen hotkey combinations are used to enter compensation / configuration mode, lock the X-KVM and disable the X-KVM's video.

REMOTE unit – Switch 4

This switch is used to select the required video compensation mode. When the switch is in the OFF position, automatic video compensation will be selected. In automatic compensation mode, the X-KVM will check the length of twisted pair cable linking the local and remote units when it is powered on. It will then adjust the video compensation amplifiers. In manual compensation mode, the video compensation setting may be adjusted by the user.

LOCAL unit – Switch 1

Set this switch to the OFF position for normal operation. This switch is used to set the X-KVM **local** unit into upgrade mode so that new firmware can be downloaded into its flash program memory.

LOCAL unit – Switch 2

This switch sets “transparent mode” operation. This mode is useful if the X-KVM is to be used to link KVM switches that are not made by Adder Technology. Cascaded KVM switches often use undocumented data to signal special conditions. In transparent mode the X-KVM will enable this undocumented data to be transferred between devices.

LOCAL unit – Switch 3

If this switch is set to the ON position then the **remote** unit will go directly into compensation / configuration mode at power on. This enables a password locked **remote** unit to be reset. See section 4.6 for further details.

LOCAL unit – Switch 4

This switch may be used to reset the **local** unit without disconnecting the power. In the OFF position the X-KVM will operate normally. In the ON position X-KVM will suspend all operation and reset itself to the power off condition. Cycling the switch from the OFF position to the ON position and back to the OFF position again will perform a reset without having to disconnect the computer connection cable.

Top of AdderLink X-KVM REMOTE

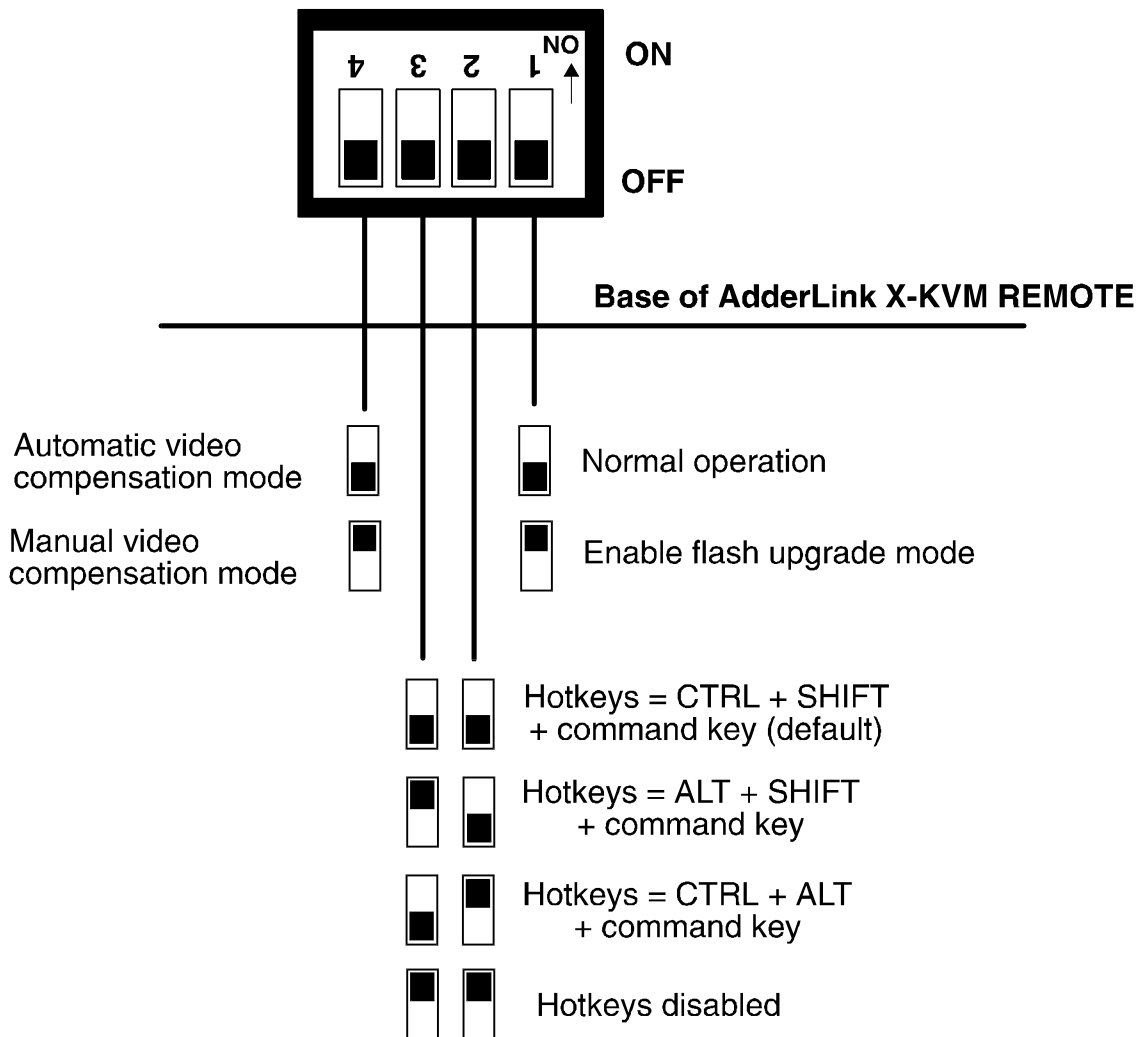

Figure 7 – X-KVM remote module option switches

Top of the AdderLink X-KVM LOCAL

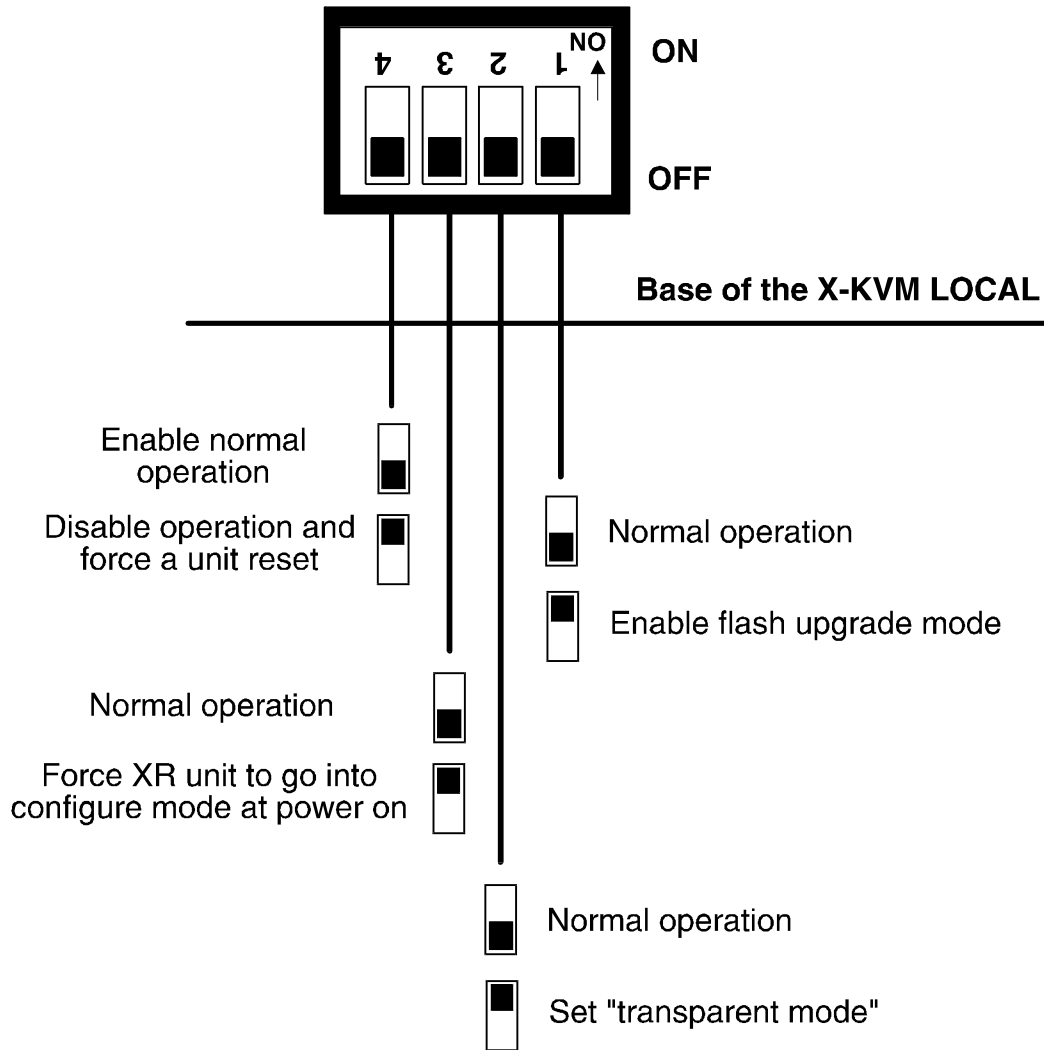



Figure 8 – X-KVM *local* module option switches

2.7 Setting the video compensation manually

The X-KVM incorporates fine video compensation amplifiers to maximise the picture quality for any given length of twisted pair cable. The X-KVM can be set to automatically adjust the compensation amplifiers to match the cable or you can adjust the amplifiers manually. Automatic compensation is enabled by setting option switch 4 on the *remote* unit to the OFF position. Manual compensation is selected if switch 4 is in the ON position. The best video compensation setting is often a matter of personal preference and so for the best picture quality we recommend that you fine tune the amplifiers manually. To do this use the following procedure.

STEP 1

Enter video compensation mode by pressing the HOTKEYS together with  on the keyboard connected to the *remote* receiver unit. The HOTKEYS are those that were set using the option switches (CTRL + SHIFT by default).

For example, assuming the default hotkeys, press these keys together :



STEP 2

The X-KVM will now be in compensation adjustment mode. This is indicated by the NUM, CAPS and SCROLL lock lights on your keyboard. These will flash in sequence at a rate that indicates the level of compensation: a slow rate of flash indicates a compensation setting suitable for short lengths of twisted pair cable and a fast rate of flash indicates a compensation setting that is suitable for long lengths of twisted pair cable.

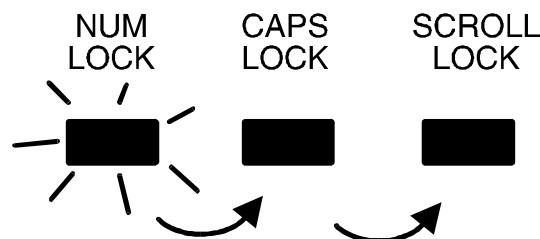

Active light cycles from num to caps to scroll and back to num again - rate of cycling indicates increases with greater levels of video compensation

Press  to select no video compensation.

You should now see a 'fuzzy' video picture on your monitor connected to the **remote** receiver unit.

STEP 3

You may now use the following keys to select the required video compensation.

 Selects no video compensation.

 Increases video compensation to sharpen picture (coarse adjustment).

 Increases video compensation to sharpen picture (fine adjustment).

 Decreases the video compensation (coarse adjustment).

 Decreases the video compensation (fine adjustment).

Various other keys may also be used to select operating options (see section 2.10)

As you change the video compensation setting you will see the sharpness of the picture change. The X-KVM calculates the required brightness automatically. You will need more video compensation for longer twisted pair cable distances. Adjust the video compensation until you achieve the best picture. If you add too much compensation then the picture may be lost. If this happens reduce the compensation to restore the picture.

The best compensation setting may be set using the following technique.

- Press  until you observe white trailing edges on the right hand side of black text or graphics.

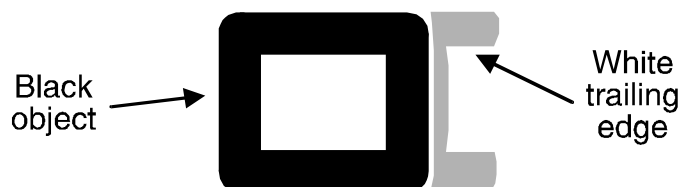

- Press and release  until the white trailing edges just disappear.

STEP 4

Press  to exit from compensation mode.

The X-KVM saves the selected video compensation setting when you exit from compensation mode. This setting is retained within the AdderLink even when the power is off and so unless you change the twisted pair cable you will not need to re-adjust the compensation setting again.

If automatic video compensation mode has been selected using option switch 4 then the X-KVM will automatically calculate and store a new compensation setting the next time the remote unit is powered on or reset. To stop this happening and keep your manually selected setting permanently, select manual compensation mode by setting option switch 4 on the **remote** unit to the ON position.

2.8 Performing special functions and selecting user configurable options



The X-KVM supports a number of special functions and user-configurable options. These functions and options are accessed whilst the X-KVM is in video compensation / configuration mode.

To enter configuration mode press the HOTKEYS together with  on the keyboard connected to the XR receiver unit. The HOTKEYS are those that were set using the option switches (CTRL + SHIFT by default).

For example, assuming the default hotkeys, press these keys together :



Functions and options are accessed by pressing a letter key followed by a number key followed by the RETURN key. For example to run the function that resets the X-KVM to its factory default settings:

Whilst within configuration mode press   

The num, caps and scroll lock lights will indicate correct acceptance of the command as follows:

- In compensation / configuration the num, caps and scroll lock lights will flash in sequence.
- After pressing the first key of a command sequence the num, caps and scroll lock lights will all be illuminated.
- After pressing the second key of a command sequence the num and caps lock lights will be on and the scroll lock light will be off.
- After pressing RETURN the command will have been accepted and the num, caps and scroll lock lights will go back to flashing in sequence.

When you have finished selecting options, return to normal operation by pressing



2.9 Summary of X-KVM functions and options

Full details of each of the configuration options and their uses are given in section 4.



- Reports the X-KVM's firmware version. The connected computer must be running an application that displays typed keys as screen characters – e.g. a word processor or command prompt.



- Force the X-KVM to calculate and apply the automatic video compensation setting.



- For users with QWERTY keyboard layouts - reports the length difference (skew) between the twisted pairs that are carrying the video colour signals between the *local* and *remote* units. Also reports the best settings for a skew compensation unit (if needed). The connected computer must be running an application that displays typed keys as screen characters – e.g. a word processor or command prompt.
(see section 6.4 for more details)



- For users with AZERTY keyboard layouts - reports the length difference (skew) between the twisted pairs that are carrying the video colour signals between the *local* and *remote* units. Also reports the best settings for a skew compensation unit (if needed). The connected computer must be running an application that displays typed keys as screen characters – e.g. a word processor or command prompt.
(see section 6.4 for more details)



- Resets all user-configurable options to the default state (see 4.3)
(see section 5.1 for more details)



- Sets “Microsoft” compatible mouse protocol signalling.



- Selects “Logitech” compatible mouse protocol signalling.

(see section 5.2 for more details)





- Reset mouse function (see section 2.11)



- Reset IntelliMouse function (see section 2.11)



– Sets a security password (see section 4.6)

   – Clears the security password (see section 4.6)

2.10 Other useful installation information

PC boot up sequence - When your PCs are powered on they communicate with any attached keyboards and mice and setup parameters required by the particular operating system. It is necessary for the X-KVM to be attached and powered on during this sequence so that it can give the required responses and keep track of all the modes and settings requested by each of the connected PCs.

Mouse characteristics - do not unplug a PS/2 mouse connection from a PC whilst the PC is on. Due to the design of PS/2 mice communications the mouse function on the PC will be lost and you will have to re-boot the PC to regain normal operation. Unplugging the mouse from the X-KVM will also cause it to stop operating when it is plugged back in. RS232 mice can usually be unplugged and plugged back in provided that a mouse was connected when the operating system initially booted.

Keyboard and mouse mode switching - The X-KVM keeps a log of the keyboard and mouse mode and resolution settings requested by the connected PC. These settings are automatically communicated to the keyboard and mouse as required to ensure maximum software compatibility. The keyboard num, caps and scroll lock states are an obvious example of this process.

2.11 Hot plugging the X-KVM into running systems and re-enabling disconnected CPU PS/2 mouse connections

It is advisable to switch off the systems that are going to be connected to the X-KVM before installation. However if this is not possible then most systems can be hot plugged by using the X-KVM's mouse restoration functions. The keyboard connection will normally restore itself automatically.

On many PCs, mouse movement will be lost if the PS/2 mouse is unplugged and plugged back in whilst the PC is running. Mouse movement can then only be restored by rebooting the PC. This is because the mouse drivers only setup and enable the mouse when the PC is initially booted.

If you have switched off your X-KVM or you are attempting to 'hot plug' it into a system that is already running, you may be able to restore lost mouse movement using the X-KVM's mouse restoration functions.

Mouse restoration functions should be used with care as unpredictable results may occur if the wrong mouse type is selected. If in doubt restore the mouse by powering down the PC normally.

Standard PS/2 mouse data uses a different data format to IntelliMouse data and so two reset functions are provided on the X-KVM. The type of data format expected by the PC depends upon the driver and the type of mouse that was connected when the driver was booted. The following table may be used as a guide.

Note that the mouse reset functions predict the likely mouse resolution settings but may not restore the speed or sensitivity of the mouse exactly as they were when the PC originally booted.

Type of mouse / system Connected at bootup	Driver type	Likely expected data format	Suggested restoration
PS/2	PS/2 only	PS/2	M6
PS/2	IntelliMouse	PS/2	M6
IntelliMouse / KVM Switch	PS/2 only	PS/2	M6
IntelliMouse/ KVM Switch	IntelliMouse	IntelliMouse	M7

To restore lost mouse movement on a CPU connected to the X-KVM:

- 1) Ensure that the video picture of the CPU that has lost its mouse movement is displayed on the monitor connected to the **remote** unit.
- 2) Enter the configuration mode by pressing 'HOTKEYS' and RETURN on the keyboard connected to the **remote** unit. For example:



- 3) To restore a PS/2 mouse connection press



Or, to restore an IntelliMouse connection press



4) Exit from configure mode by typing 

5) Test the mouse movement by moving the mouse a short distance.

2.12 Using the X-KVM/R with Adder SmartView XPro KVM switches

The X-KVM remote receiver is compatible with the extender ports fitted to Adder SmartView XPro KVM switches. A typical installation using an X-KVM remote receiver and Adder SmartView XPro is shown in figure 9.

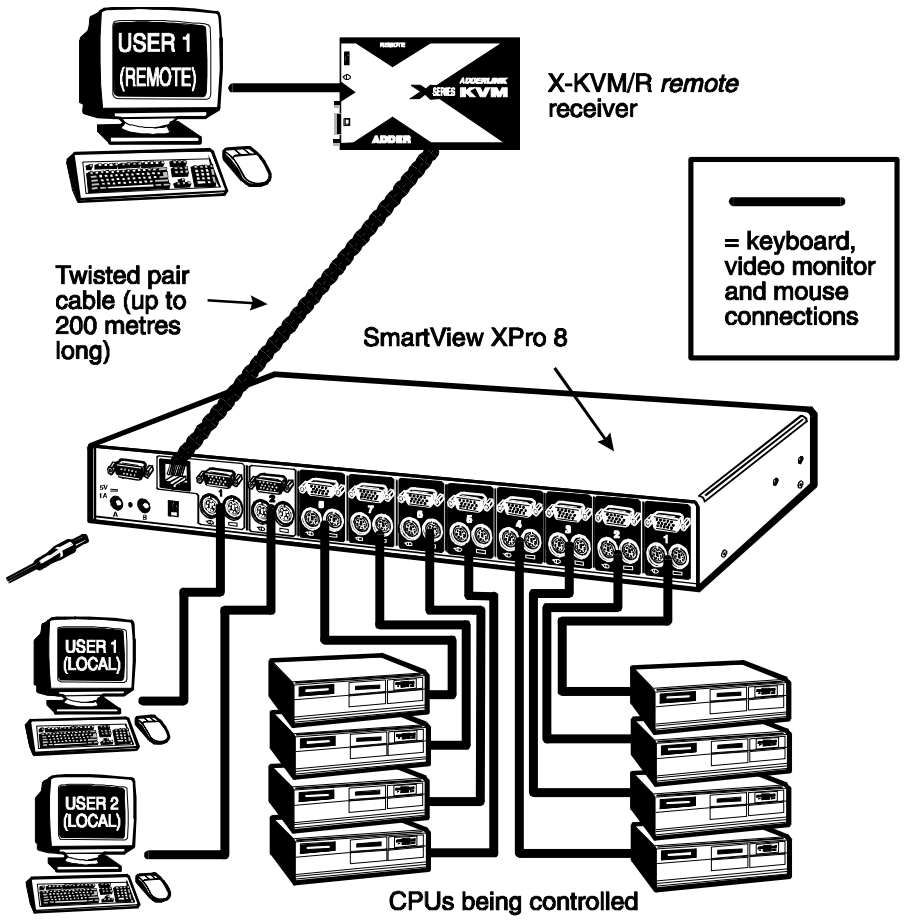

Fig. 9 - A typical installation using an X-KVM/R and a SmartView XPro

3. Rack mounting X-Series products in the 19 inch rack mount chassis

3.1 Mounting X-Series modules into the rack mount chassis

X-Series products may be rack mounted in the X-Series 19 inch rack mounting chassis (part code X-RMK-CHASSIS). Up to 16 X-Series modules may be mounted in each 2U chassis. You will need to purchase a rack securing plate for each module that you wish to mount in the chassis. Part codes for the rack securing plates are as follows:

X-Series module	Rack securing plate
X-KVM <i>local</i> transmitter	X-RMK-KVM/T
X-KVM <i>remote</i> receiver	X-RMK-KVM/R
X-SC skew compensator unit	X-RMK-SC

Each rack securing plate is provided with two counter-sunk screws which may be used to attach the securing plate to the X-Series module.

1. Attach the securing plate to the module using the two counter-sunk screws provided.
2. Offer the assembly into the rack mounting chassis as shown in figure 10 and locate the module so that the two pan head screws fit inside the mating fixing holes in the base of the rack mount chassis.
3. Use the pan head screw to attach the securing plate to the rack mount chassis.

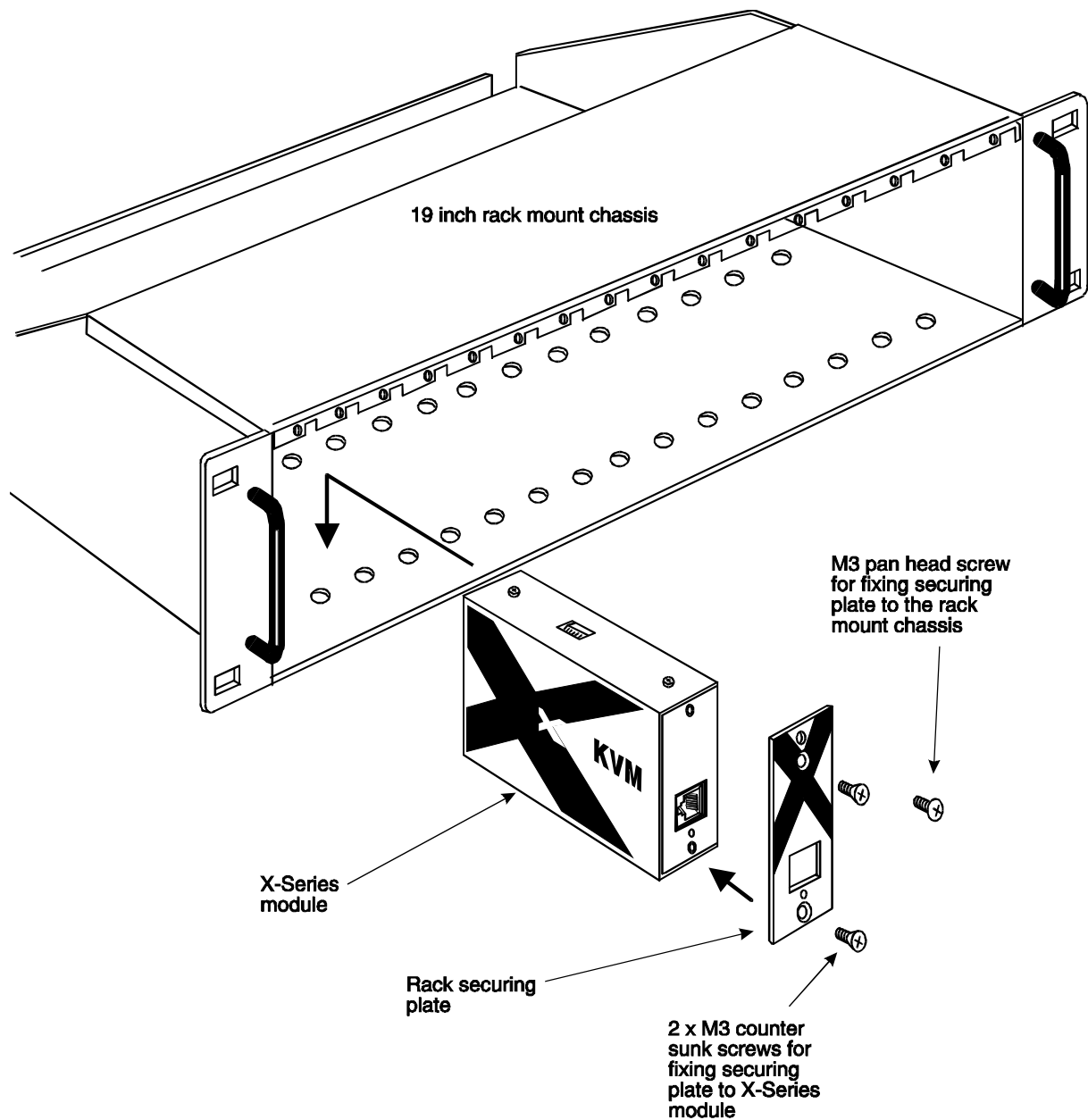

Figure 10 – Rack mounting X-Series modules

3.2 Installing and using the rack mountable power distribution module

If you are rack mounting multiple X-KVM/R units then it is undesirable to use separate power supplies for each of these modules. The X-Series power distribution module (part code X-PDM4) may be used to power these units and create a neater installation. The power distribution module enables you to power up to 4 X-KVM/R units from the single power adapter supplied with the power distribution module.

Short patch cables are provided with the power distribution module to connect its four power outlets to the rack mounted X-KVM/R modules. A power indicator on the power distribution module confirm that power is available. The power distribution module's power outlets are designed to provide 500mA of current at 5 volts.

Patch cables are available to enable the *local* transmitter to be connected to the power distribution module – Please contact your supplier.

3.3 Blanking plates for the 19 inch rack mount chassis

The 19 inch rack mount chassis may be populated with any mixture of X-Series modules. Each chassis will house up to 16 modules. If the chassis is not fully populated then unused mounting positions (slots) may be left empty.

In some installations it is necessary to ensure that there are no gaps in the front face of the chassis assembly so that the airflow and cooling characteristics of the rack are maintained. In these installations, unused slots may be filled (blanked off) using X-Series blanking plates. These are available to blank off one or four slots. Part codes are:

X-RMK-BLANK	Single slot blanking plate
X-RMK-BLANK4	Quad slot blanking plate

4. Using the X-KVM extender

This section explains the general operation of the X-KVM. We recommend that you read this section before starting to use the product.

4.1 Power on status

The X-KVM is ready for use as soon as the **remote** receiver and **local** transmitter have been powered on. Remember that the **local** transmitter draws its power from the computer via the keyboard cable and the **remote** unit draws its power from the supplied power adapter.

If a security password has not been set then the X-KVM **remote** unit will power on and immediately establish a link to the remote computer attached to the **local** unit. If a security password has been set then the X-KVM **remote** unit will not display any video. The X-KVM will indicate that it is waiting for a password to be entered by alternately illuminating the num and scroll lock lights and then the caps lock light on the keyboard attached to the **remote** receiver unit.

4.2 AdderLink indicator lights

The X-KVM **local** and **remote** unit indicator lights have the following meaning

Status	Meaning
ON	X-KVM is on and there is sufficient power available
OFF	X-KVM is off and sufficient power is not available
FLASHING	X-KVM is sending or receiving keyboard or mouse data
SLOW FLASHING	X-KVM is in upgrade mode

4.3 Keyboard NUM, CAPS and SCROLL lock indicators

The X-KVM uses the keyboard NUM, CAPS and SCROLL lock lights to indicate various operating conditions as follows:

NUM, CAPS and SCROLL lock lights flash in sequence

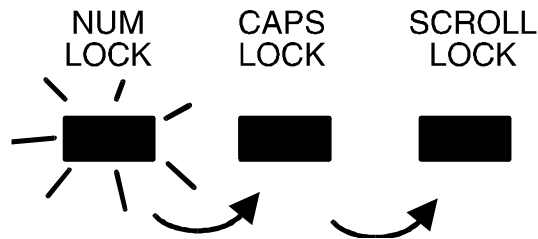

The X-KVM flashes the NUM, CAPS and SCROLL lock lights in sequence on the keyboard connected to the **remote** unit to indicate that the X-KVM is in video compensation / configuration mode. The NUM lock light comes on first with CAPS and SCROLL off. Then the CAPS lock comes on with NUM and SCROLL off and finally the SCROLL lock comes on with NUM and CAPS off. The rate of flashing indicates the level of video compensation applied by the video compensation amplifiers. A slow flash rate indicates a small amount of compensation (short twisted pair cable distance). A fast flash rate indicates a greater level of video compensation for longer cables.

NUM and SCROLL lock flash alternately with CAPS lock

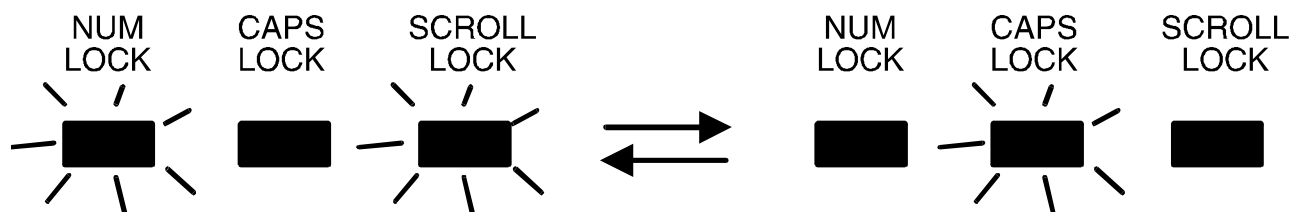

The X-KVM alternately flashes NUM and SCROLL lock and then CAPS lock on the keyboard attached to the **remote** unit to indicate that the X-KVM is currently locked and is awaiting a password to be entered by the user to unlock the X-KVM.

4.4 Keyboard hotkey control

The X-KVM *remote* unit may be set to respond to various keyboard hotkey combinations. These keyboard hotkeys are selected using the option switches on the side of the X-KVM *remote* unit (see section 2.6). Keyboard hotkeys may be used to switch off the video, lock the X-KVM and enter video compensation / configuration mode.

All of the hotkey control commands are invoked by holding down the two hotkeys and then pressing a command key. By default, the two hotkeys are 'CTRL' and 'SHIFT', although other combinations can be selected by reconfiguring the hotkeys (see section 2.6). Once the hotkey command has been activated you will need to release the hotkeys and the command key before a new hotkey command is accepted by the X-KVM.

The hotkey commands are summarised below (**IMPORTANT NOTE: the numbers on the numeric keypad do not form part of a valid hotkey**) :

'HOTKEYs' and '0' – switches off the video signal on the *remote* unit and disconnects the keyboard and mouse from the computer that they are currently controlling. This will cause some monitors to go into standby mode or switch off. The video signal can be re-enabled by selecting a computer using 'HOTKEYs' and 'TAB' or 'HOTKEYs' and '1'.

'HOTKEYs' and 'L' - Disconnects the X-KVM *remote's* keyboard and mouse from the computer that they are controlling. The video signal is switched off. If a password has not been set then the X-KVM can be re-enabled by using 'HOTKEYs' and 'TAB' or 'HOTKEYs' and '1'. If a password has been set then the X-KVM will alternately flash the NUM and SCROLL and then the CAPS lock lights on the keyboard connected to the *remote* unit. This indicates that a valid password must be entered to unlock the X-KVM. Simply type the same key combination as was set during configuration (see section 4.6) followed by the RETURN key. Note - if anyone has typed at the keyboard whilst in secure mode, it will be necessary to type RETURN first to clear the invalid password, then type the valid password followed by RETURN again.

'HOTKEYs' and '1' - selects the remote computer attached to the *local* unit.

'HOTKEYs' and 'TAB' – selects the remote computer attached to the *local* unit.

‘HOTKEYS’ and RETURN – Enters video compensation / configuration mode

Examples of common hotkey sequences (assuming CTRL + SHIFT hotkey option):

To lock the X-KVM:

press    release   

To disable the video signal and blank the monitor:

press    release   

4.5 Entering and exiting video compensation / configuration mode

The X-KVM’s video compensation and user selectable options and functions are accessed in compensation / configuration mode. To enter this mode press the selected hotkey combination together with the RETURN key and to exit this mode press the RETURN key again. For example:

To enter compensation / configuration mode:

press    release   

To exit compensation / configuration mode:

press  release 

4.6 Setting and using the security password

There are many situations where unrestricted access to computers or sensitive information needs to be controlled. In such circumstances, the X-KVM **local** unit may be locked away in a room or secure cabinet and the computer may be controlled remotely from the **remote** unit.

The X-KVM incorporates a security password system that enables the **remote** unit to be locked so that the secure computer cannot be controlled. Once a password has been set the X-KVM **remote** unit may be disabled by pressing the hotkeys together with the L (lock) key. The **remote** unit may only then be unlocked by entering the password. For example if the hotkeys are set to CTRL and SHIFT then pressing the following key combination would cause the X-KVM **remote** unit to lock.



When the **remote** unit is locked the video is switched off and the keyboard and mouse are disconnected from the computer. Locking the **remote** unit does not affect the operation of the **local** unit.

To unlock the AdderLink **remote** unit enter the password followed by the RETURN key e.g.:



NOTE - The password consists of a combination of key strokes rather like the code to a safe. The key strokes are not case sensitive and can include all the keys on the keyboard (except ctrl, alt, shift and enter). Consequently the following 'password' would be valid:



To set the password, enter configuration mode by typing 'HOTKEYS' and RETURN on the keyboard attached to the **remote** unit (see section 2.8). When in configure mode type 'P' then RETURN. Now enter the password which may be up to 40

characters. The password is not case sensitive and can be any combination of key strokes, including the function keys, but excluding the CTRL, ALT, SHIFT and RETURN keys. When you have typed in your password type RETURN to register it in the stored memory. Do not worry if you type the password incorrectly, you can always re-enter configure mode and set the password again.

For example, to enter OPENUP as the password type the following whilst in configuration mode:



What to do if your X-KVM is locked and you have lost or forgotten the password

If your X-KVM is locked and you have lost or forgotten the password then you may clear the password if you have access to the *local* unit. To clear the password power down the *remote* unit and switch option switch 3 on the *local* unit to the on position (see section 2.6). When you next power on the *remote* unit it will go straight into configuration mode allowing you to clear or change the password. You will then need to set option switch 3 on the *local* unit back to its default (off) position or the *remote* unit will go into configuration mode every time that you switch it on.

4.7 Querying the X-KVM's firmware version

For technical support purposes it is sometimes useful to know the firmware version of the X-KVM. The X-KVM can report its firmware version using a configuration mode function.

To find the firmware version of your X-KVM you will first need to be running a program on your computer that displays text when you type at the keyboard. Suitable programs are text editors, word processors or command prompts. It doesn't matter what program you use provided that the characters typed in at the keyboard are displayed on the screen. Enter configuration mode by pressing 'HOTKEYs' and RETURN together (see section 4.5). Now type the following on the keyboard connected to the *remote* unit:



The version number will be reported on the computer screen as the letter V followed by three numbers. For example, if the X-KVM reports V118 then the firmware version is 1.18.

5. X-KVM configuration options

All the options described in this section are entered in X-KVM's configuration mode - see section 4.5 for instructions on entering configuration mode.

5.1 Resetting all configuration options to their default state

To reset all the X-KVM's configuration options to the default state press the following whilst within configuration mode. By resetting all the configuration options to their default state you will also clear the password but you will not change the video compensation setting.



5.2 Selecting a mouse signalling protocol

Most mouse drivers are compatible with Microsoft mice and so a "Microsoft compatible" mouse signalling protocol is suitable for most systems. In some installations, Logitech mouse drivers may disable the action of the mouse buttons when used with the "Microsoft compatible" signalling protocol implemented by the X-KVM. To solve this problem select the "Logitech compatible" mouse signalling protocol.



- Sets "Microsoft compatible" mouse protocol signalling.



- Selects "Logitech compatible" mouse protocol signalling.

6. Configuring and using the skew compensator

6.1 What is the skew compensator and why is it needed?

The skew compensator corrects the video colour split that is sometimes introduced when a video picture is transmitted over twisted pair cables. Twisted pair cables are typically constructed using four pairs of twisted wires. Each of the pairs of wires are normally twisted at slightly different rates to reduce the crosstalk between the pairs. This is highly advantageous for digital data transmission but can sometimes cause a problem when the cables are used to carry video signals. The reason for this is that three different pairs are used to carry the red, green and blue colour components of the video picture. If the length of cable used is long enough and the twist rates differences between the twisted pairs are large enough then there will be a significant length difference between the wires that carry the different video colour signals. This means that the colour signals will arrive at the X-KVM *remote* receiver at different times and the colours on the video picture will appear to split causing the picture clarity to be reduced. A typical characteristic of this colour split effect is a red, green or blue shadow around bright white objects. The skew compensator removes this colour split by deliberately delaying some of the colour signals so that all the signals arrive at the *remote* receiver at the same time.

6.2 Can I predict if a skew compensator will be needed?

It is remarkably difficult to predict if a skew compensator will be needed because twisted pair cables from different manufacturers have substantially different characteristics. Although Category 5e and Category 6 cables typically have larger twist rate differences than Category 5 cables there are several types of Category 5e and Category 6 cables with low twist rate differences. With similar specification cables, the colour split introduced by one cable may be four times the colour split introduced by another apparently similar cable. What's more, colour split effects become more noticeable at higher screen resolutions. The reason for this is that the pixel time on higher resolution screens is shorter and so a given colour delay represents more pixels.

As a general rule, colour signal skew is more of a problem with higher specification cables (i.e. Cat 6 / Cat 5e), longer cable lengths and higher screen resolutions. For

example, an installation running a screen resolution of 1024 x 768 over 50 metres of Cat 5 cable will probably exhibit minimal colour split whereas an installation running a screen resolution of 1600 x 1200 over 100 metres of Cat 6 cable will probably exhibit some noticeable colour split.

6.3 Correcting colour split

If you have a noticeable problem with colour split then you have several choices. You could use a shorter length of twisted pair cable or a different type of twisted pair cable. Alternatively you could reduce the screen resolution that you are using. If none of these are possible then the colour split may be corrected using the X-Series skew compensator. The skew compensation unit is inserted into the twisted pair cable connection between the local transmitter and remote receiver as shown in figure 11.

For the technically minded . . .

The X-Series KVM extender will report the length difference between the pairs that are used to carry the red, green and blue colour signals (see section 6.4). This length difference can be used to calculate the colour split effects. Each metre of cable represents 5 nanoseconds of delay. A rough estimate of the time for each screen pixel may be calculated by multiplying the horizontal pixels by the vertical pixels by the refresh rate and then dividing 1 by the result. If the delay time is greater than the pixel time, colour split will be noticeable.

For example, if the maximum reported length difference is 1.5 metres then the delay between colour signals will be 1.5×5 nanoseconds = 7.5 nanoseconds. If the screen resolution being used is 1024 x 768 x 75 Hz then a rough estimate of the pixel time is $1 / (1024 \times 768 \times 75) = 16.9$ nanoseconds. Consequently the colour split will be less than half a pixel time and so is unlikely to be noticeable.

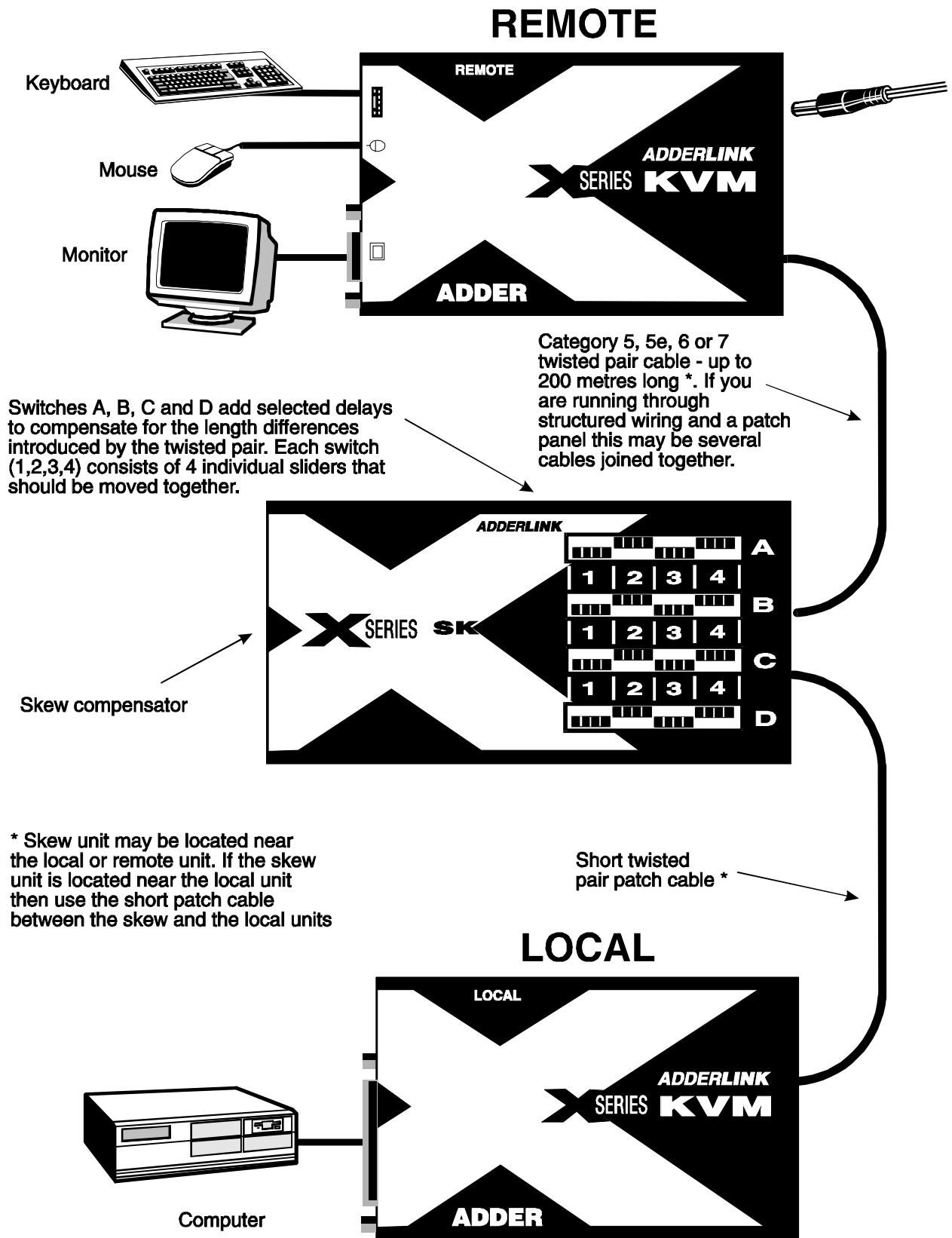

Figure 11 – Installing the skew compensator

6.4 Reporting the cable skew and configuring the skew compensator

The skew compensator is specifically designed for use with X-Series KVM extenders but may also be used with most analogue KVM extenders. The X-Series KVM extenders report the required skew compensator settings making setup and configuration easy. For other extender systems the skew compensator may be setup manually.

To get the X-KVM to report the skew compensator settings:

STEP 1

Connect the X-KVM local transmitter and remote receiver together with the twisted pair cable(s) that you are going to use. If you already have a skew compensator then connect this as shown in figure 11 but set all the switches to the OFF position.

STEP 2

Ensure that the video picture is correctly compensated (see section 2.7). If the video picture is not correctly compensated then the reported skew settings may be less accurate.

STEP 3

Open a text editor, DOS command prompt or word processor application on the computer that is being controlled. Any application that displays typed keys as characters on the screen will do. The X-KVM reports the skew compensation by generating a set of faked key presses (as if you had typed the report from the keyboard).

STEP 4

Enter video compensation / configuration mode by pressing the HOTKEYS together with  on the keyboard connected to the **remote** receiver unit. The HOTKEYS are those that were set using the option switches (CTRL + SHIFT by default). For example, assuming the default hotkeys, press these keys together :



STEP 5

If you have a QWERTY keyboard layout (English, German etc.) then press:



If you have an AZERTY keyboard layout (French) then press:



The screen will go blank for a few seconds whilst the X-KVM applies measurement signals to the cable to measure the length differences between the twisted pairs. When the picture is restored a report similar to that shown below will be generated:

<p>SKEW REPORT</p> <p>RED +0.5M GREEN +1.0M BLUE +0.0M</p> <p>SWITCHES ON A3 B4</p>

The first section of the report indicates the length differences between the twisted pairs that are carrying the red, green and blue signals. One of the colours will have a reported length difference of 0.0M – this colour is carried by the SHORTEST twisted pair. The other reported lengths indicated the difference between the twisted pair used to carry the colour signal and the shortest twisted pair.

The second section of the report indicates the skew compensator switches that should be switched ON to compensate for the twisted pair length differences indicated by the report. All other switches should be OFF. You will see that each of the switches is constructed using 4 individual sliders. To set the switch ON, all four sliders must be moved to the ON position. To set the switch OFF, all four sliders must be set to the OFF position. The example skew report shown above indicates that switches A3 and B4 should be ON and all the other switches should be OFF.

To compensate for colour split, setup the skew compensator as indicated and insert it in the twisted pair cable run between the *local* transmitter and *remote* receiver as

shown in figure 11. You will need a short patch lead to do this.

The settings that are reported represent the compensation required to remove the skew that is introduced by the twisted pair cable. There is sometimes some colour skew present on video signals being generated by the computer. Consequently the video picture can sometimes be slightly improved by using skew compensator settings that are slightly different to those reported (see section 6.5).

STEP 6

Exit from compensation / configuration mode by pressing:



For the technically minded . . .

When the skew compensator is used with AdderLink KVM extenders, switch bank A (i.e. switches A1 to A4) adds delay to the twisted pairs that carry the BLUE colour. In the same way, switch banks B and C add delay to the twisted pairs that carry the RED and GREEN colours respectively. Other KVM extenders may carry colour signals on different twisted pairs.

The delays added by the various switches are as shown below. Switch 1 adds the most delay and switch 4 adds the least delay. Any combination of switches may be selected to make up the required delay (e.g. switches 1,3 and 4 together will add a total delay of approximately 17.5 nanoseconds).

<i>Switch 1</i>	<i>10 nanoseconds</i>	<i>(equivalent to 2 metres of cable)</i>
<i>Switch 2</i>	<i>10 nanoseconds</i>	<i>(equivalent to 2 metres of cable)</i>
<i>Switch 3</i>	<i>5 nanoseconds</i>	<i>(equivalent to 1 metre of cable)</i>
<i>Switch 4</i>	<i>2.5 nanoseconds</i>	<i>(equivalent to 0.5 metres of cable)</i>

6.5 Setting up the skew compensator manually

If the skew compensator is to be used with a KVM extender that does not have a skew setting reporting feature then you will need to setup the skew compensator manually. To do this you will first need to determine which of the switch banks

controls which of the colours (on all AdderLink products, switch bank A is BLUE, B is RED and C is GREEN).

To determine which switch bank controls the delay of which colour you must first install the skew compensator as shown in figure 11. Set all the switches to the OFF position. Now set all the switches in one bank (e.g. A1 to A4) to the ON position and observe the change to the video picture. The delayed colour should appear as a shadow on the right hand side of white objects that are on a dark background. This shadow may best be observed if you have a picture with white objects set against a black background. For example, if you create a picture similar to that shown below in a drawing package such as Paint then the delayed colour will be seen on the right hand side of the white square.

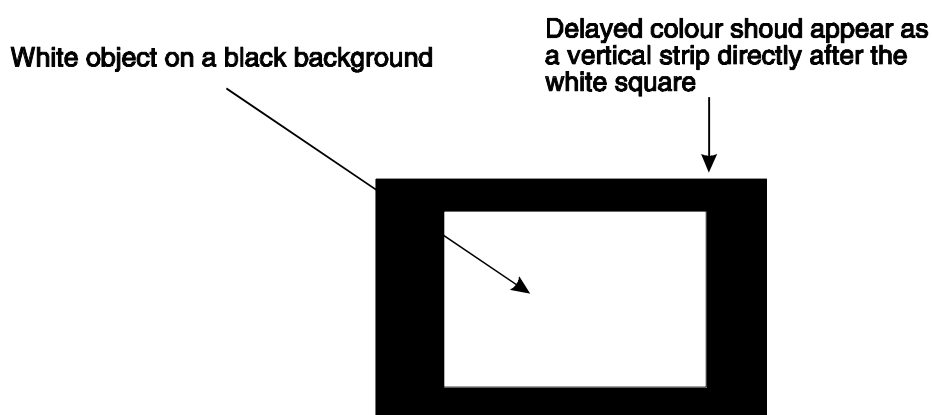

Once you have determined which set of switches controls which colour you can switch all the switches OFF and observe the picture. Remember that the picture is made up from red, green and blue colour signals. Use a test pattern similar to that shown above and observe the component colour that is most delayed (i.e. the one that appears as a shadow after a white image on a black background). Leave all the switches associated with this colour in the OFF position and start to add delays to the OTHER colours by setting some of their associated switches to the ON position. Observe the changes to the picture after you change the switches. Switches 1 and 2 each introduce a 10 nanosecond delay. Switch 3 introduces a 5 nanosecond delay and switch 4 introduces a 2.5 nanosecond delay.

A process of trial and error is required to find the best switch settings.

7. Upgrading the X-KVM's flash memory

The X-KVM uses flash memory technology which enables the firmware code to be upgraded by the user. Upgrades are performed by using a PC program to download the new firmware via the keyboard connection. The **local** transmitter and **remote** receiver both contain microprocessors with flash rewritable program memory. They may be independently upgraded but we highly recommend that you always upgrade both the **local** and **remote** units when performing an upgrade.

To perform a flash upgrade you will need to create an MS-DOS boot disk. This boot disk is used to run the upgrade program automatically without the need for keyboard control. From DOS systems, a boot disk can be created using the DOS FORMAT command (e.g. FORMAT A: /S). For Windows 95 and 98, DOS boots disks can be created in a similar manner. For other versions of Windows refer to Windows Help for instructions. For example, a DOS disk can be created from Windows XP by selecting **My Computer**, right clicking on the A disk icon, selecting **Format** and then selecting **Create an MS-DOS startup disk**.

To upgrade the X-KVM's firmware

STEP 1

Create an MS-DOS boot disk using a blank floppy disk.

STEP 2

Download the latest firmware upgrade files from the Adder Technology website (www.addertec.com). The firmware upgrade is available as a compressed ZIP file containing the following files (xxx is the version number of the firmware – for example 108 is version 1.08).

XKVMxxx.EXE	The download program (e.g. XKVM108.EXE) – this automatically selects the firmware to use by detecting the unit that is connected during download.
XREMxxx.HEX	The firmware file for the remote receiver (e.g. XREM108.HEX)
XLOCxxx.HEX	The firmware file for the local transmitter (e.g. XLOC108.HEX)
AUTOEXEC.BAT	The autoexec file for the DOS boot disk that automatically runs the upgrade file (XKVM.EXE)

Copy these four files to the root directory of the MS-DOS boot disk (you will need to overwrite the AUTOEXEC.BAT file that is currently on the DOS disk).

STEP 3 (connecting the *local* transmitter)

Power down your computer. Disconnect the twisted pair cable from the local transmitter and connect the **local** transmitter to your computer as shown below. You only need to connect the keyboard cable between the **local** transmitter and the computer. Plug the monitor directly into the back of the computer.

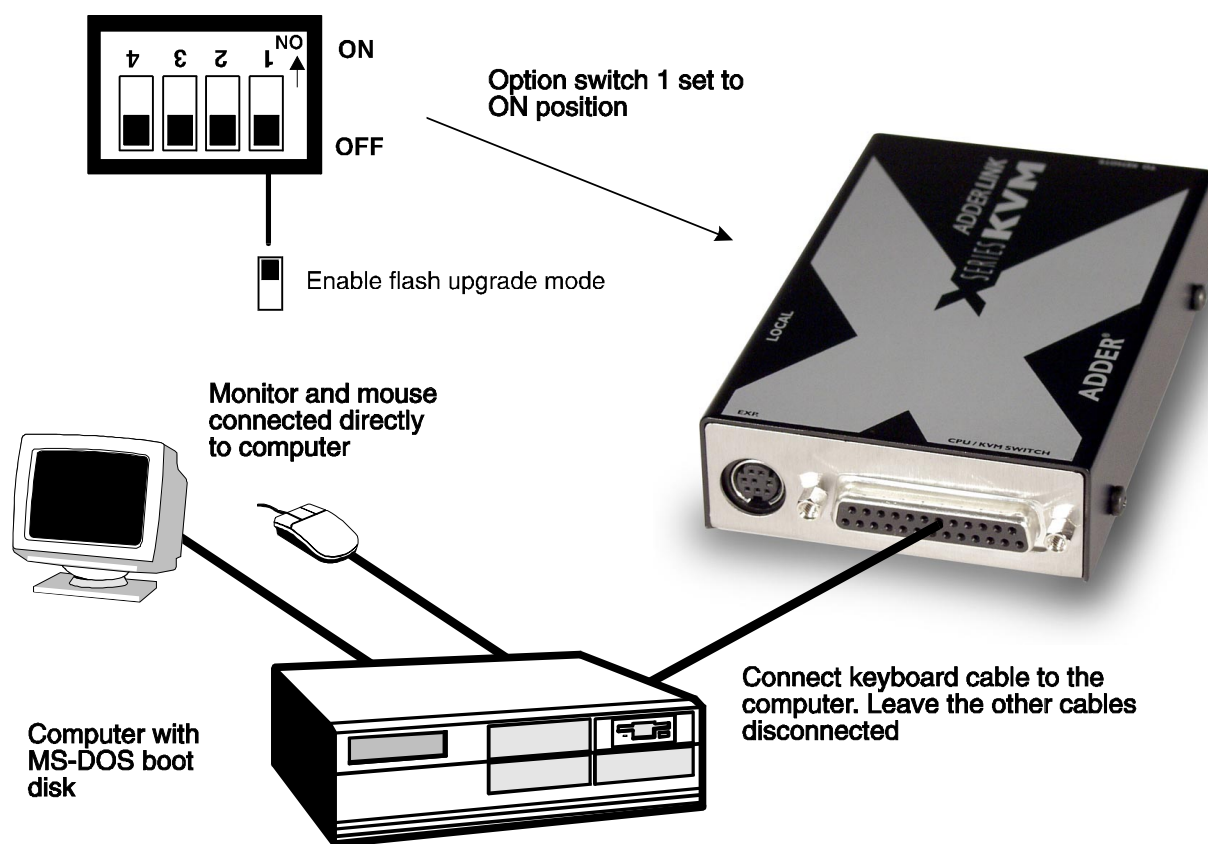

STEP 4 (upgrading the **local** transmitter)

Set the X-KVM's option switch 1 to the ON position. Insert the DOS disk into your computer's floppy drive and power on your computer. The upgrade should be performed automatically. When the upgrade has completed, switch off your computer and disconnect the **local** transmitter. Set option switch 1 back to the OFF position.

STEP 5 (connecting the **remote** receiver)

Power down your computer. Power down the **remote** receiver. Disconnect the twisted pair cable from the **remote** receiver. **Do not power any of the devices yet.** Connect the **remote** receiver to your computer as shown below. To do this you will need a keyboard cable (6 pin mini-DIN male to 6-pin min-DIN male, all lines connected). If you have a KVM switch product the chances are that you will have one of these connecting the switch to a computer. You only need to connect the keyboard cable between the **remote** receiver and the computer. Plug the monitor

directly into the back of the computer.

This configuration might seem strange to you because the keyboard port on the X-KVM *remote* receiver would normally be connected to a keyboard and not to a computer keyboard port. The product is designed to reverse the operation of the keyboard port during the flash upgrade process.

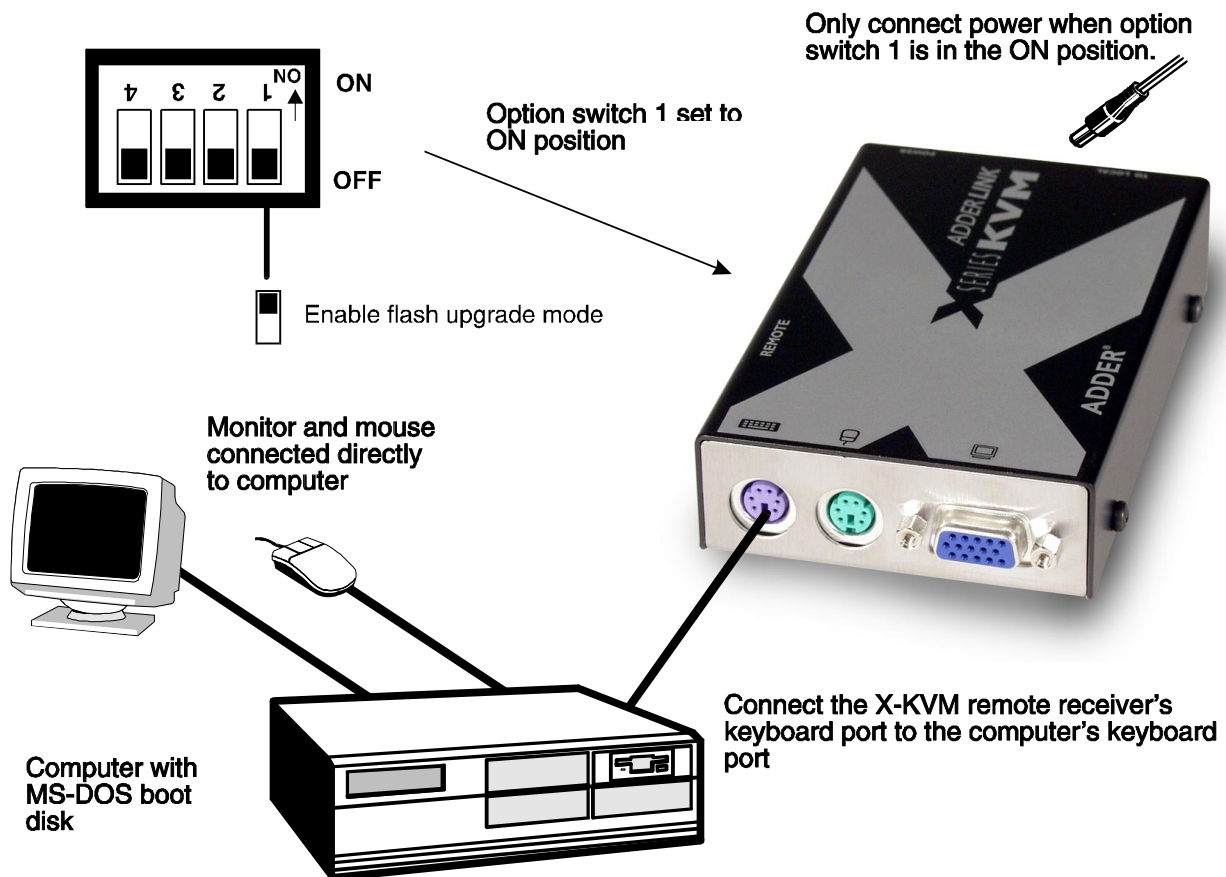

STEP 6 (upgrading the *remote* receiver)

Set the X-KVM's option switch 1 to the ON position. Power the X-KVM *remote* receiver by connecting the power adapter. Insert the DOS disk into your computer's floppy drive and power on your computer. The upgrade should be performed automatically. When the upgrade has completed, switch off your computer and disconnect the *remote* receiver. Set option switch 1 back to the OFF position.

Reconnect the upgraded X-KVM as shown in figure 6.

Appendix A. Cable and connector specifications

IMPORTANT NOTE

The maximum cable lengths supported vary widely between devices and cables. It may be possible to use cables that are longer than those specified below with certain PCs and peripherals but this cannot be guaranteed. If you experience problems try using shorter cables.

A1. Keyboard, monitor and mouse connections

All of these devices plug directly into the relevant ports of the X-KVM. If you use an AT style keyboard you will need an AT (5 pin DIN female) to PS/2 (6 pin mini-DIN male) converter.

Cable specification for connections from the *remote* unit to the keyboard, monitor and mouse

Ideally keyboard, monitor and mouse cables should not be longer than 10 metres. Many keyboards and mice will also operate at distances of 20 metres but this cannot be guaranteed. If you are using a monitor extension cable then you should ensure that this is a high quality tri-coax type.

A2. Computer connections

Cables for connection to PCs:

When used without the auxiliary power adapter, cables to PCs may be up to 5 metres long. With the optional power adapter the cables may be extended up to 30 metres using standard extension cables. Video extension cables should be good quality with a coaxial construction. Please contact your supplier if you have any questions.

Part code	Description	Length
VADD-PS2-2M	Cable for connection to PCs	2 metres
VADD-PS2-5M	Cable for connection to PCs	5 metres

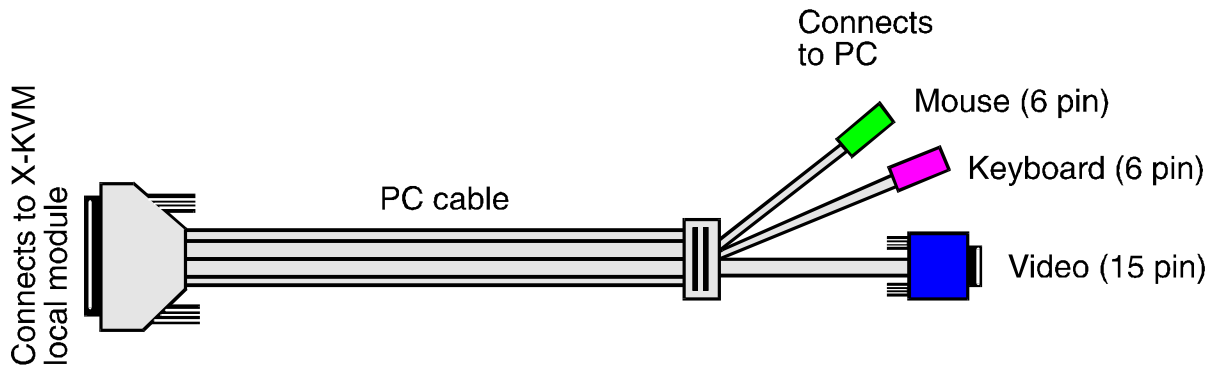

Adapters:

VSA2 keyboard adapter - If your PC has a 5-pin DIN AT style keyboard connector you will need a PS/2 to AT keyboard adapter 6-pin mini-DIN female to 5-pin DIN male.

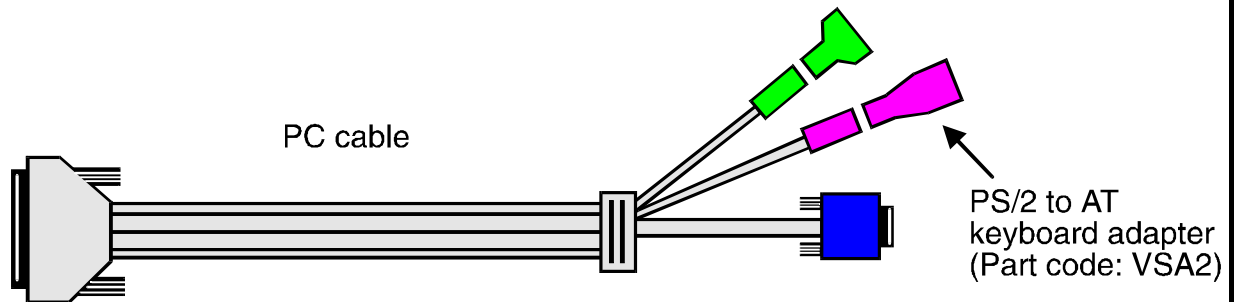

VSA1 mouse adapter - This is required if you wish to connect a computer that has a 9-pin serial mouse connection:

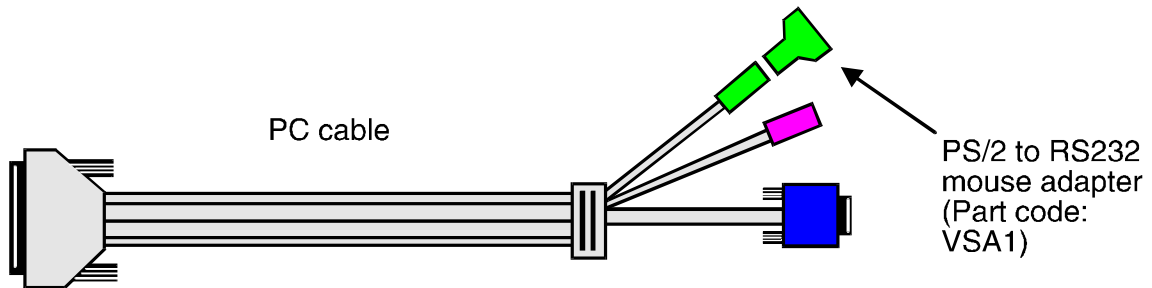

6 pin mini-DIN female

plugs into cable from X-KVM

9 pin D female

plugs into PC serial port

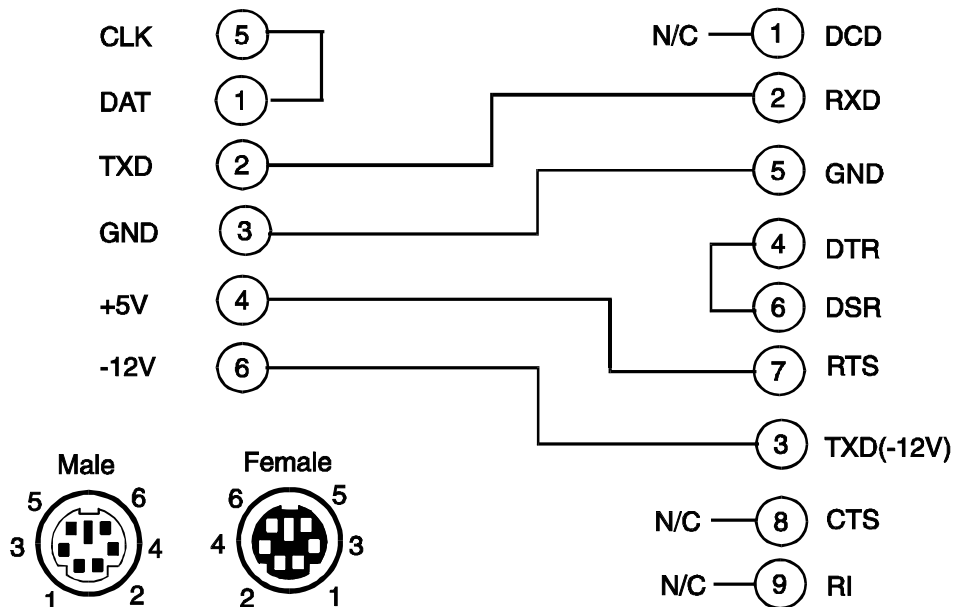

Cables should be no longer than 30 metres.

NOTE - There are several common wiring specifications for 6-pin mini-DIN to 9-pin serial adapters. If you have an adapter that has been supplied with a mouse it may have a completely different internal wiring to that shown above and may not be compatible with the X-KVM

A3. Twisted pair cable

Many types of twisted pair cables are available. You may use unshielded twisted pair (UTP) or shielded twisted pair (STP) cable with the X-KVM. Ensure that the cable you use is of Category 5 or better specification.

The AdderLink uses the following pairs on the twisted pair RJ45 jack connector. If your cable is terminated for networking use then it will probably be wired correctly for the AdderLink. All four twisted pairs within the cable are used by the AdderLink. Electrically, the cables should be wired with pin 1 to pin 1, pin 2 to pin 2, 3 to 3, 4 to 4, 5 to 5, 6 to 6, 7 to 7 and 8 to 8.

The usage of the various twisted pairs is shown below:

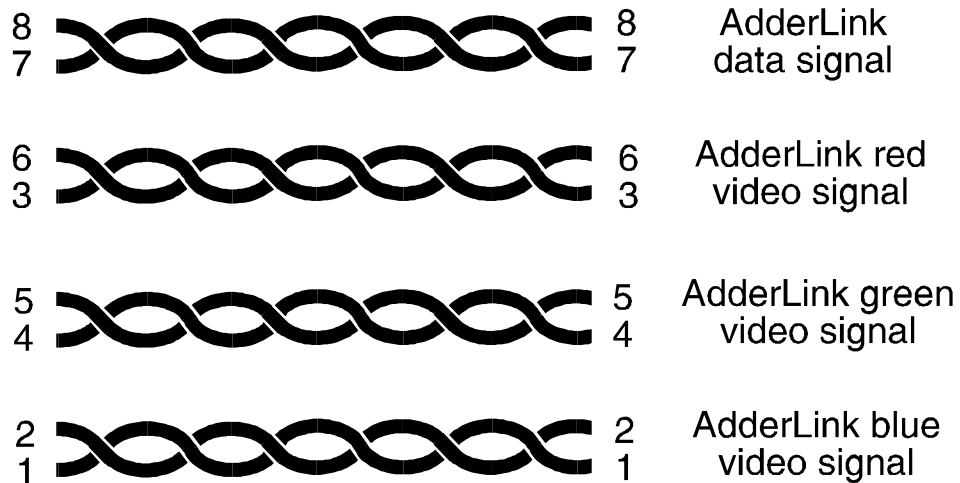
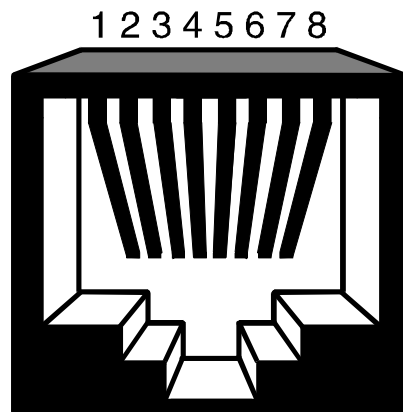

ADDER *Link* X SERIES

INSTALLATION & USE

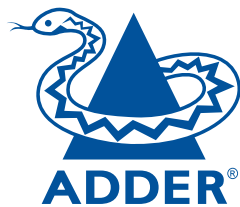

ADDER Technology Limited

Technology House
Trafalgar Way
Bar Hill
Cambridge
CB3 8SQ • England

T: +44 (0) 1954 780044
F: +44 (0) 1954 780081
sales@addertec.com
www.addertec.com