



GE
Lighting



2D™ Watt-Miser™
F282DT5/835/4P BL 1/20 WM

10567

Product information

Biax™ 2D™ compact fluorescent lamps have been available for many years but GE is introducing the next generation of lamps under the name of 2D™ Watt-Miser™. These are available in 16, 21, 28 and 38 Watt in a wide choice of colour temperatures, these lamps are a direct replacement to existing 2D fixtures delivering the same life of 15,000 hours in case of 28 and 38 Watt but additional energy saving performance, 2D™ Watt-Miser™ lamps give similar lumen as the lamps they are replacing but up to 12% energy saving dependent upon ballast and wattage. Saving energy cost: 16W lamp runs on 14W*, 21W lamp runs on 19W*, 28W lamp runs on 24W* and 38W runs on 34W*. In response to the demand from the market for a higher light output version of the 2D™ lamp, GE offers the 55W using the T5 28W/38W envelope size. The high luminous efficacy has been retained in the 55W by incorporating an amalgam which overcomes the fall in efficacy that occurs with increased lamp loading. The 55W lamp has a cap with dedicated key. The cap material withstands the higher temperatures generated by the increased lamp power while the modified holder key for the 55W 2D™ will prevent accidental insertion of any lower rated



2D™ lamp into a 55W socket. The T5 size (14% smaller overall diameter) will allow luminaire manufacturers to design new fittings with improved optical control in addition to the well-known uniformity of light of the Biax™ 2D™ concept.

(*When used with electronic ballast)

Product data

Cap/Base	GR10q
Bulb Shape	2D
Bulb maximum overall diameter [mm]	202
Maximum Overall Length [mm]	204
Net weight per piece [g]	100
Gross weight per piece [g]	164
Operating position	U - Universal
Mercury Content [mg]	3
UV radiance	exempt
Brand	General Electric (GE)

Performance data

Colour Code	835
Colour Rendering Index (CRI) [Ra]	82
Nominal correlated colour temperature (CCT) [K]	3500
Nominal lumens [lm]	2150
Energy efficiency class (EEC)	A
Rated Life [h]	15000
Rated median life on electronic (HF) ballast on IEC 12-hour cycle	21000
Rated median life on electronic (HF) ballast on IEC 3-hour cycle	18000
Weighted energy consumption [kWh/1000h]	26.95

Electrical data

Nominal power [W]	28
Nominal lamp voltage [V]	108
Operating Temperature (MIN) [°C]	-15
Starting ambient temperature range	-15
Dimming Capability	Yes

Logistic data

DUN Code	20043168105679
EAN Code	0043168105675
Pack Quantity	20
Inner pack type	BLISTER
Outer pack type	OUTER BOX
Layer quantity	80 EUR, 120 UK
Layer quantity EUR	80
Layer quantity UK	120
Pallet quantity EUR (PC)	320
Pallet quantity UK (PC)	480
Outer case size	488 x 388 x 271 (mm)
Product status	Available

Application areas



Technical drawing

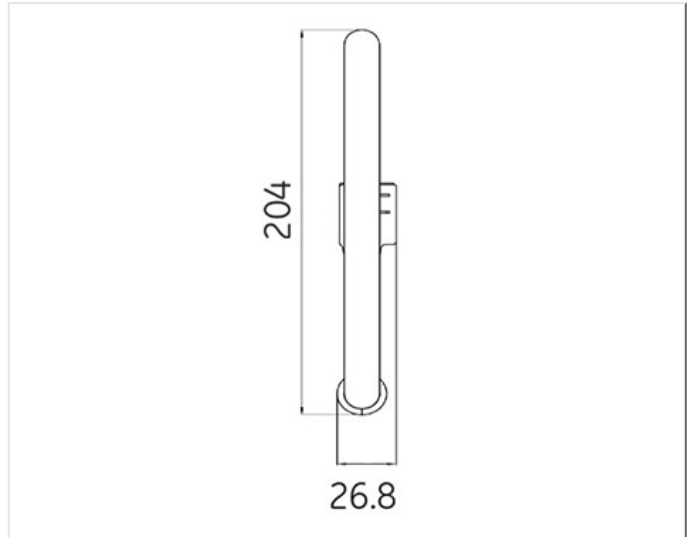
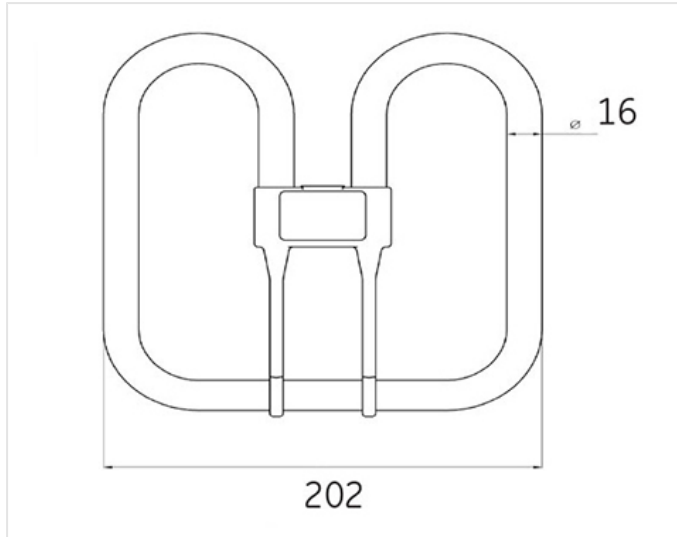

Survival Data

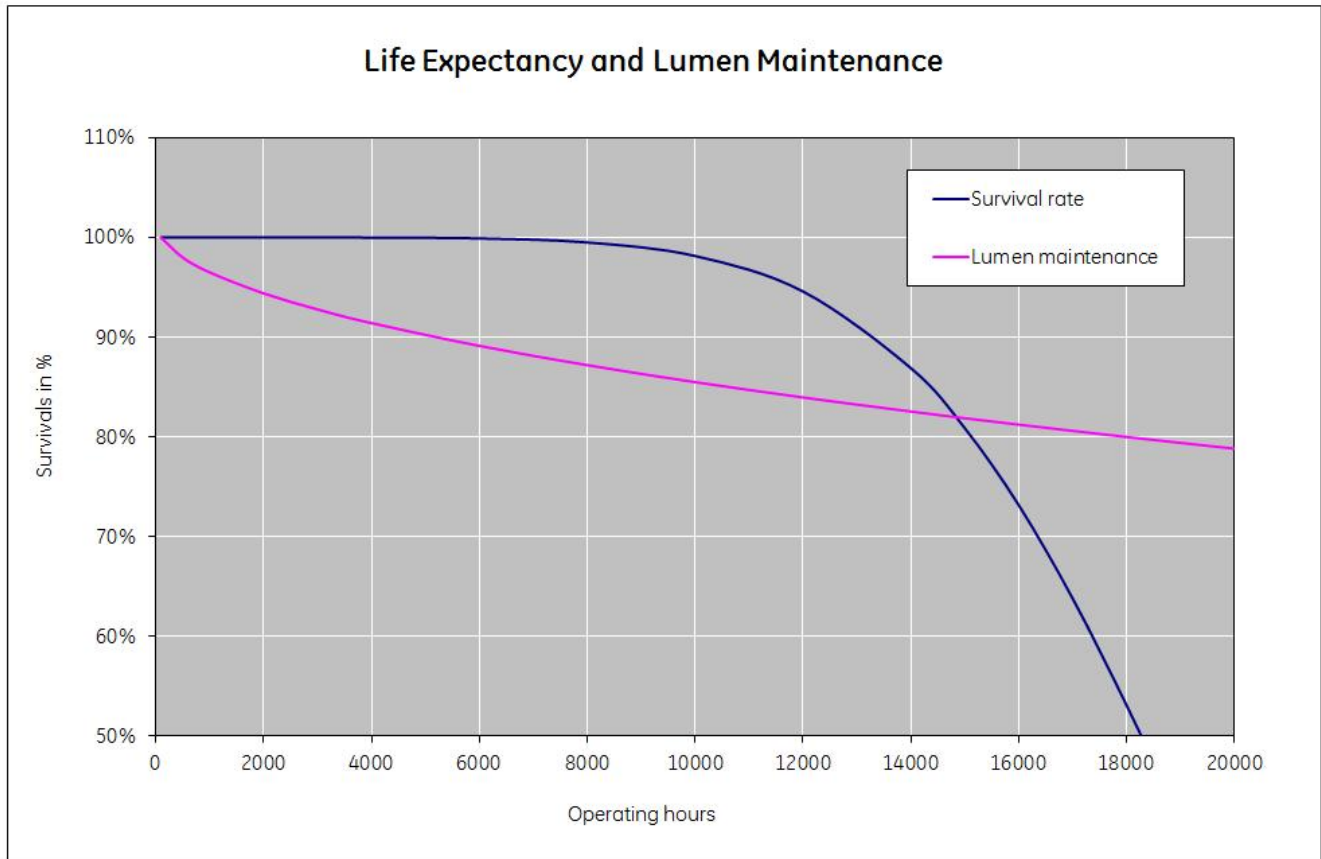

Downloads & Links

[Go to the catalog site \(HTTP\)](#)

[CFL Non-Integrated Spectrum Catalogue \(PDF\)](#)

[2D™ and 2D™ Watt-Miser™ Data sheet \(PDF\)](#)

[Lighting design tools & calculators \(HTTP\)](#)

[Disposing and Cleaning of CFL Lamps \(HTTP\)](#)