

KEMET, L-RMS, RF, 4700 pH, +/-0.3 nH

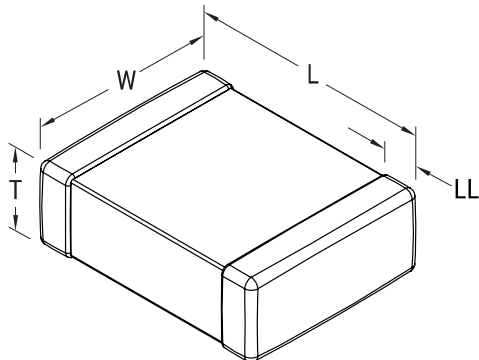

Dimensions	
Chip Size	0402
L	1mm +/-0.05mm
W	0.5mm +/-0.05mm
T	0.5mm +/-0.05mm
LL	0.25mm +/-0.1mm

Packaging Specifications	
Packaging:	T&R
Packaging Quantity:	10000

General Information	
Series:	L-RMS
Style:	SMD Chip
Description:	Surface Mount Inductor
RoHS:	Yes
Core:	Ceramic
Winding Type:	Multilayer

Specifications	
Inductance:	0.0047 uH (100 MHz)
Inductance Tolerance:	+/-0.3 nH
Temperature Range:	-55/+125C
Current:	300 mAmps (MAX)
DC Resistance:	0.21 Ohms
Quality Factor:	10 at 100 MHz, 24 at 500 MHz, 31 at 800 MHz, 34 at 1000 MHz
Self-Resonant Frequency:	4000 MHz