



ENGLISH

Datasheet

DC Axial Fan, 120 x 120 x 25mm, 151.3m/h, 5W, 12 V dc (OD1225 Series)

RS Stock number [619-6494](#)



RS Order Number	6196494	6196501	5415097	5415104	5415356
Model Number	OD1225-12HB	OD1225-24HB	OD1225-12LB	OD1225-12MB	OD1225-24MB
Nominal Voltage	12VDC	24VDC	12VDC	12VDC	24VDC
Nominal Current	0.37 A	0.19 A	0.24 A	0.33 A	0.17 A
Rated Power	5 W	5 W	3 W	4 W	4 W
Rated Speed (RPM)	2200	2200	1800	2050	2050
Airflow (CFM)	89	89	72	83	83
Noise Level (dB)	39	39	34	38	38
Max. Static Pressure	0.14" H2O	0.14" H2O	0.10" H2O	0.12" H2O	0.12" H2O

Drawing(mm):

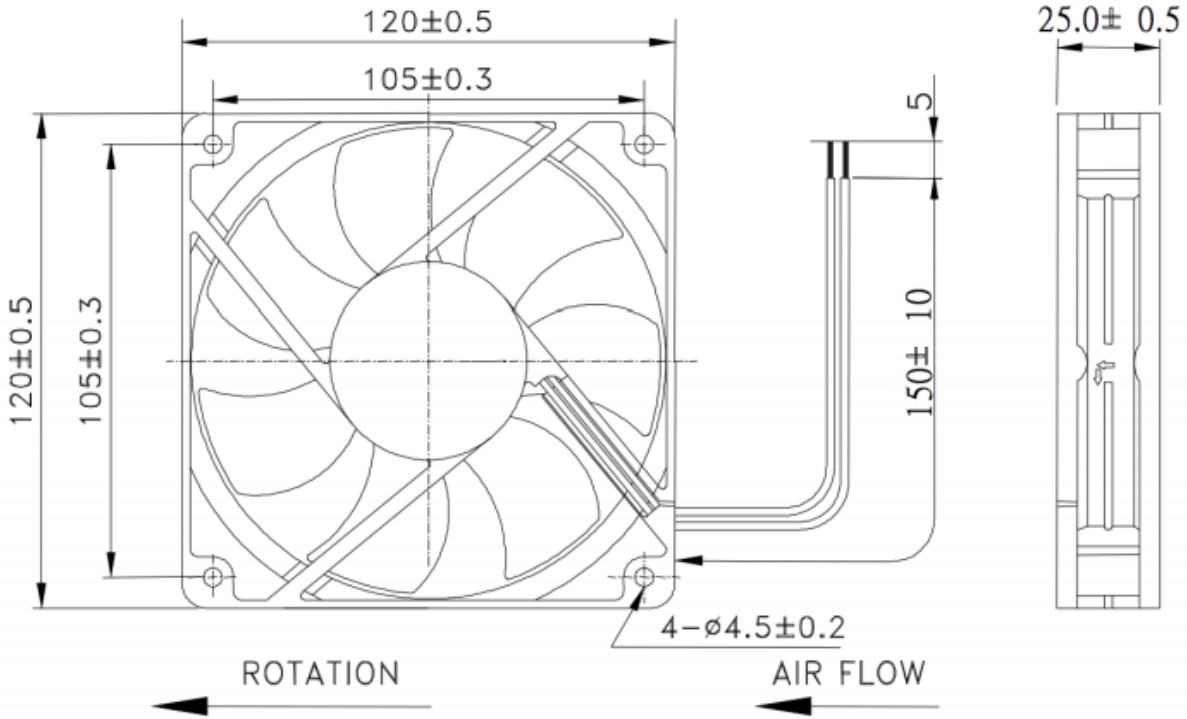

Specifications:

- Frame & Impeller: PBT, UL94V-O plastic
- Connection: 2x Lead wires 24AWG
- Motor: Brushless DC, auto restart, polarity protected
- Bearing System: Dual ball bearing
- Insulation Resistance: 10M ohm between lead wire and frame (500VDC)
- Dielectric Strength: 1 second at 500 VAC, max leakage – 500 MicroAmp
- Operating Temp: $-10^{\circ}\text{C} \sim 70^{\circ}\text{C}$
- Life Expectancy: 65,000 hours (45C)

Available options:

- Tachometer
- Alarm
- Thermal control
- IP55 water resistance
- 48V