



ENGLISH

Datasheet

DC Axial Fan, 120 x 120 x 38.5mm, 161.5m/h, 6W, 24 V dc (OD1238 Series)

RS Stock number [541-5384](#)

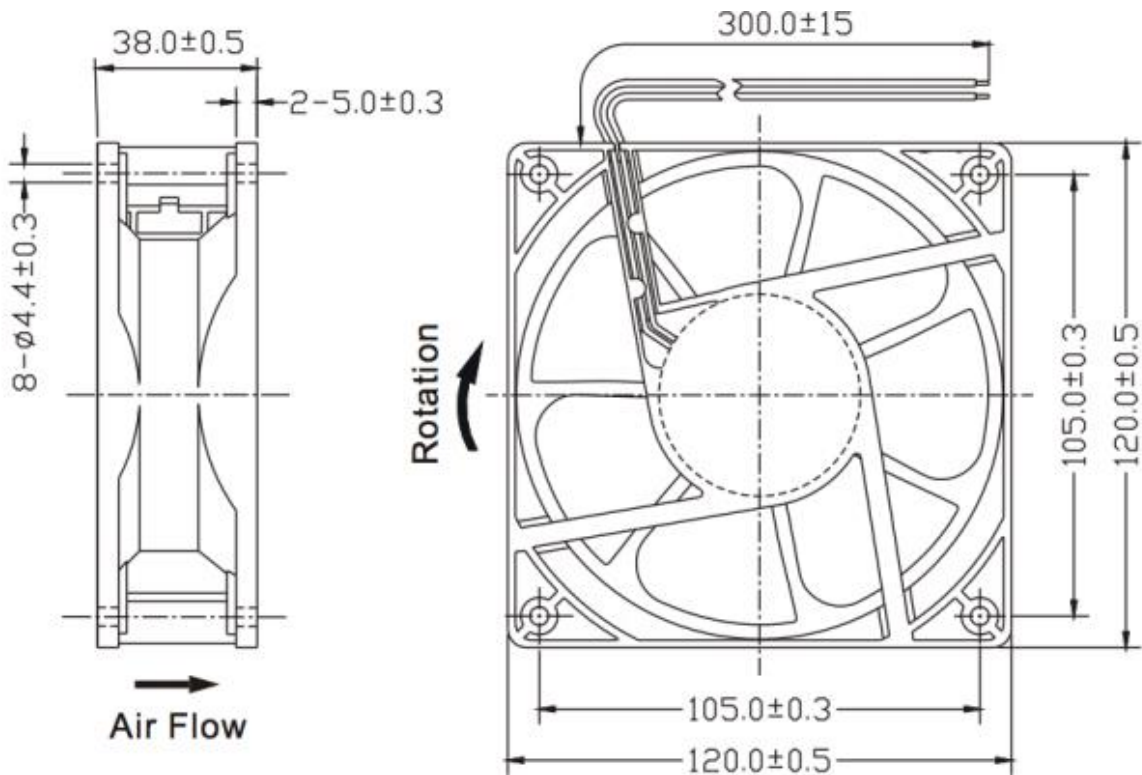

RS Order Number	5418361	5415132	5415126	5415407	5415384	5415378
Model Number	OD1238-12HB	OD1238-12MB	OD1238-12LB	OD1238-24HB	OD1238-24MB	OD1238-24LB
Nominal Voltage	6~14 VDC	6~14 VDC	6~14 VDC	12~28 VDC	12~28 VDC	12~28 VDC
Volts	12 DC	12 DC	12 DC	24 DC	24 DC	24 DC
Nominal Current	0.60 A	0.40 A	0.25 A	0.40 A	0.30 A	0.20 A
Rated Speed (RPM)	3000	2400	2000	3000	2400	2000
Airflow (CFM)	127	101	84	127	101	84
Noise Level (dB)	47	41	37	47	41	37
Max. Static Pressure	0.31" H2O	0.21" H2O	0.15" H2O	0.31" H2O	0.21" H2O	0.15" H2O

Drawing(mm):

Specifications:

Frame & Impeller:	PBT, UL94V-O plastic
Connection:	2x Lead wires 24AWG
Motor:	Brushless DC, auto restart, polarity protected
Bearing System:	Dual ball bearing
Insulation Resistance:	10M ohm between lead wire and frame (500VDC)
Dielectric Strength:	1 second at 500 VAC, max leakage – 500 MicroAmp
Operating Temp:	-20°C ~ 75°C
Life Expectancy:	65,000 hours (45C)