

# Printed-circuit board connector - DMCV 1,5/10-G1F-3,5-LR P20THR - 1787470

Please be informed that the data shown in this PDF Document is generated from our Online Catalog. Please find the complete data in the user's documentation. Our General Terms of Use for Downloads are valid (<http://phoenixcontact.com/download>)

Header, Nominal current: 8 A, Rated voltage (III/2): 160 V, Number of positions: 10, Pitch: 3.5 mm, Color: black, Contact surface: Tin, Mounting: SMD/THT/THR



The figure shows a 10-pos. version with 20 contacts

## Why buy this product

- Taped headers available on request
- Headers with flange can be combined with plugs with screw flange or with Lock & Release levers
- At 8 mm, the distance from the edge of the PCB to the first row of holes is compatible with MC headers
- Extremely small THR double-level headers for SMT and wave soldering processes



## Key commercial data

Packing unit	50 pc
GTIN	 4 046356 597098
Weight per Piece (excluding packing)	3.98 g
Custom tariff number	85366990
Country of origin	Germany

## Technical data

### Dimensions

Length	10.6 mm
Height	12 mm
Pitch	3.5 mm
Dimension a	31.5 mm
Pin dimensions	0,8 x 0,8 mm
Pin spacing	5.50 mm
Hole diameter	1.4 mm

### General

# Printed-circuit board connector - DMCV 1,5/10-G1F-3,5-LR P20THR - 1787470

## Technical data

### General

Range of articles	DMCV 1,5/...G1F-THR
Insulating material group	IIIa
Rated surge voltage (III/3)	2.5 kV
Rated surge voltage (III/2)	2.5 kV
Rated surge voltage (II/2)	2.5 kV
Rated voltage (III/3)	160 V
Rated voltage (III/2)	160 V
Rated voltage (II/2)	250 V
Connection in acc. with standard	EN-VDE
Nominal current $I_N$	8 A
Maximum load current	8 A
Insulating material	LCP
Inflammability class according to UL 94	V0
Color	black
Number of positions	10

## Classifications

### eCl@ss

eCl@ss 4.0	272607xx
eCl@ss 4.1	27260701
eCl@ss 5.0	27260701
eCl@ss 5.1	27260701
eCl@ss 6.0	27260704
eCl@ss 7.0	27440402
eCl@ss 8.0	27440402

### ETIM

ETIM 4.0	EC002637
ETIM 5.0	EC002637

### UNSPSC

UNSPSC 6.01	30211810
UNSPSC 7.0901	39121409
UNSPSC 11	39121409
UNSPSC 12.01	39121409
UNSPSC 13.2	39121409

## Approvals

### Approvals

# Printed-circuit board connector - DMCV 1,5/10-G1F-3,5-LR P20THR - 1787470

## Approvals

---

### Approvals

UL Recognized / cUL Recognized / VDE Gutachten mit Fertigungsüberwachung / IEC60947-5 CB Scheme / cULus Recognized

---

### Ex Approvals

---

### Approvals submitted

---

### Approval details

UL Recognized		
	B	C
Nominal current IN	8 A	8 A
Nominal voltage UN	150 V	50 V

cUL Recognized		
	B	C
Nominal current IN	8 A	8 A
Nominal voltage UN	150 V	50 V

VDE Gutachten mit Fertigungsüberwachung	
Nominal current IN	8 A
Nominal voltage UN	160 V

IEC60947-5 CB Scheme	
Nominal current IN	8 A
Nominal voltage UN	160 V

# Printed-circuit board connector - DMCV 1,5/10-G1F-3,5-LR P20THR - 1787470

## Approvals

cULus Recognized 

## Accessories

Accessories

Coding element

Coding profile - CP-DMC 1,5 NAT - 1790647

Coding profile, for plugging into the coding ribs of the plug or header at a later date, insulating material, color: natural



## Additional products

Printed-circuit board connector - DFMC 1,5/10-STF-3,5 - 1790373

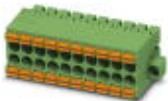

Plug, nominal current: 8 A, rated voltage (III/2): 160 V, number of positions: 10 with 20 contacts, pitch: 3.5 mm, connection method: spring-cage connection, color: green, contact surface: tin

Printed-circuit board connector - DFMC 1,5/10-ST-3,5-LR - 1790564



Plug, nominal current: 8 A, rated voltage (III/2): 160 V, number of positions: 10 with 20 contacts, pitch: 3.5 mm, connection method: spring-cage connection, color: green, contact surface: tin

## Drawings

# Printed-circuit board connector - DMCV 1,5/10-G1F-3,5-LR P20THR - 1787470

Schematic diagram

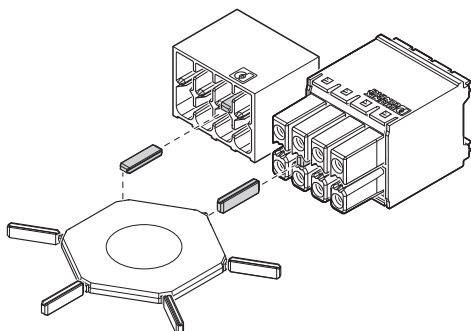

Drilling diagram

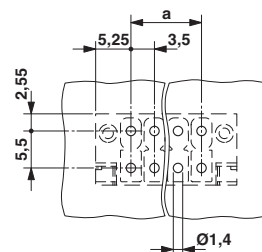

Use of the CP-DMC... coding profile

Diagram

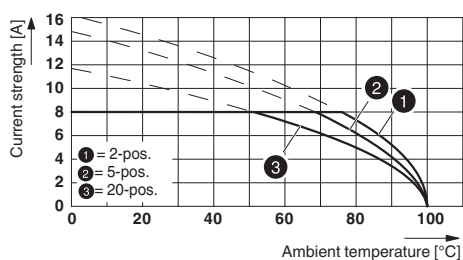

Dimensioned drawing

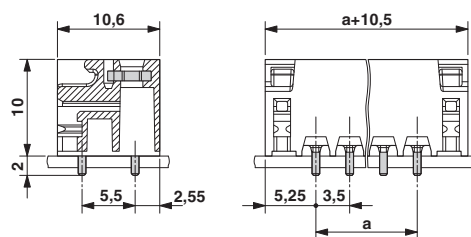

Schematic diagram

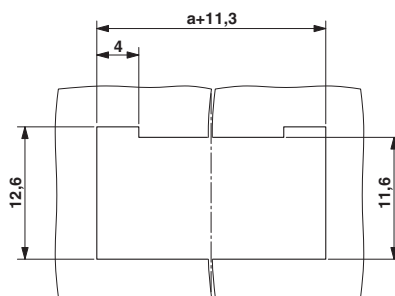

Panel cutout