

**SKF**



# SKF TKTL 30

Instructions for use  
Mode d'emploi  
Bedienungsanleitung  
Instrucciones de uso  
Manuale d'istruzioni  
Bruksanvisning

Gebruiksaanwijzing  
Instruções de utilização  
Brugervejledning  
Käyttöohje  
Οδηγίες χρήσης

## EC DECLARATION OF CONFORMITY

We, SKF Maintenance Products, Kelvinbaan 16, 3439 MT Nieuwegein, The Netherlands, declare that the

### Infrared Thermometer TKTL 30

is designed and manufactured in accordance with European Directive EMC 2004/108/EC as outlined in the standards

EN61326-1:2006

CISPR 11:2003, Class B

IEC 61000-4-2:2008

EN61326-2-2:2006

IEC 61000-4-3:2008



The Netherlands, January 2011

Sébastien David

Manager Product Development and Quality



TKTL 30  
MP5382

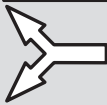

**CAUTION** AVOID EXPOSURE  
LASER RADIATION IS EMITTED  
FROM THIS APERTURE

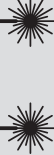

Max. Output < 1mW, Wavelength: 635-650nm  
Complies with 21CFR, Chapter 1, Subchapter J



LASER RADIATION  
DO NOT STARE INTO BEAM  
CLASS II LASER PRODUCT



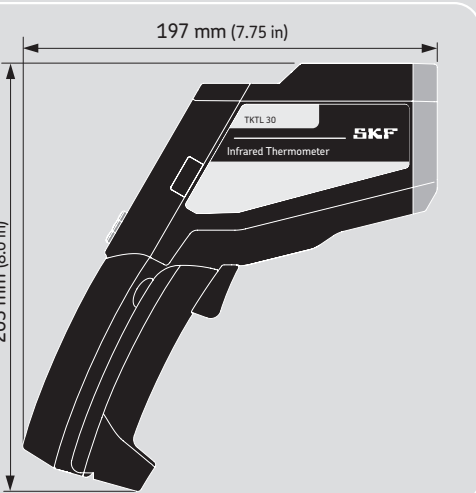
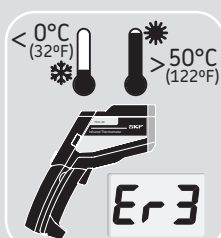
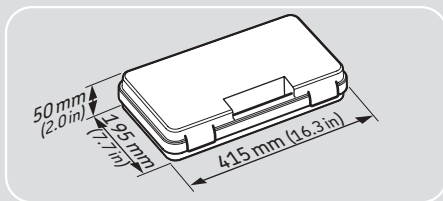
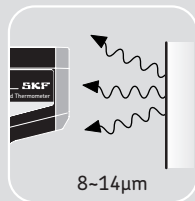
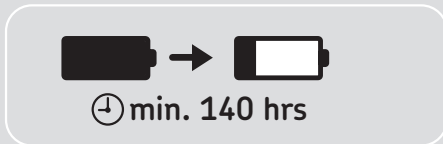
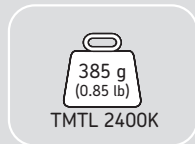
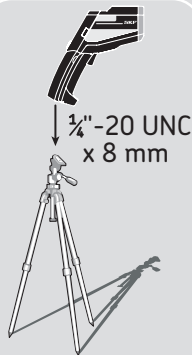
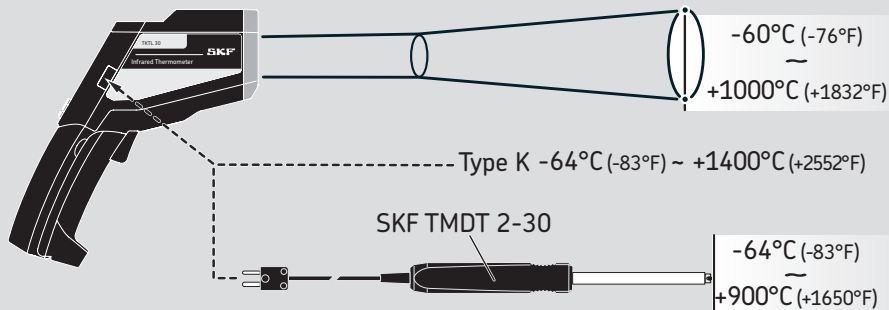

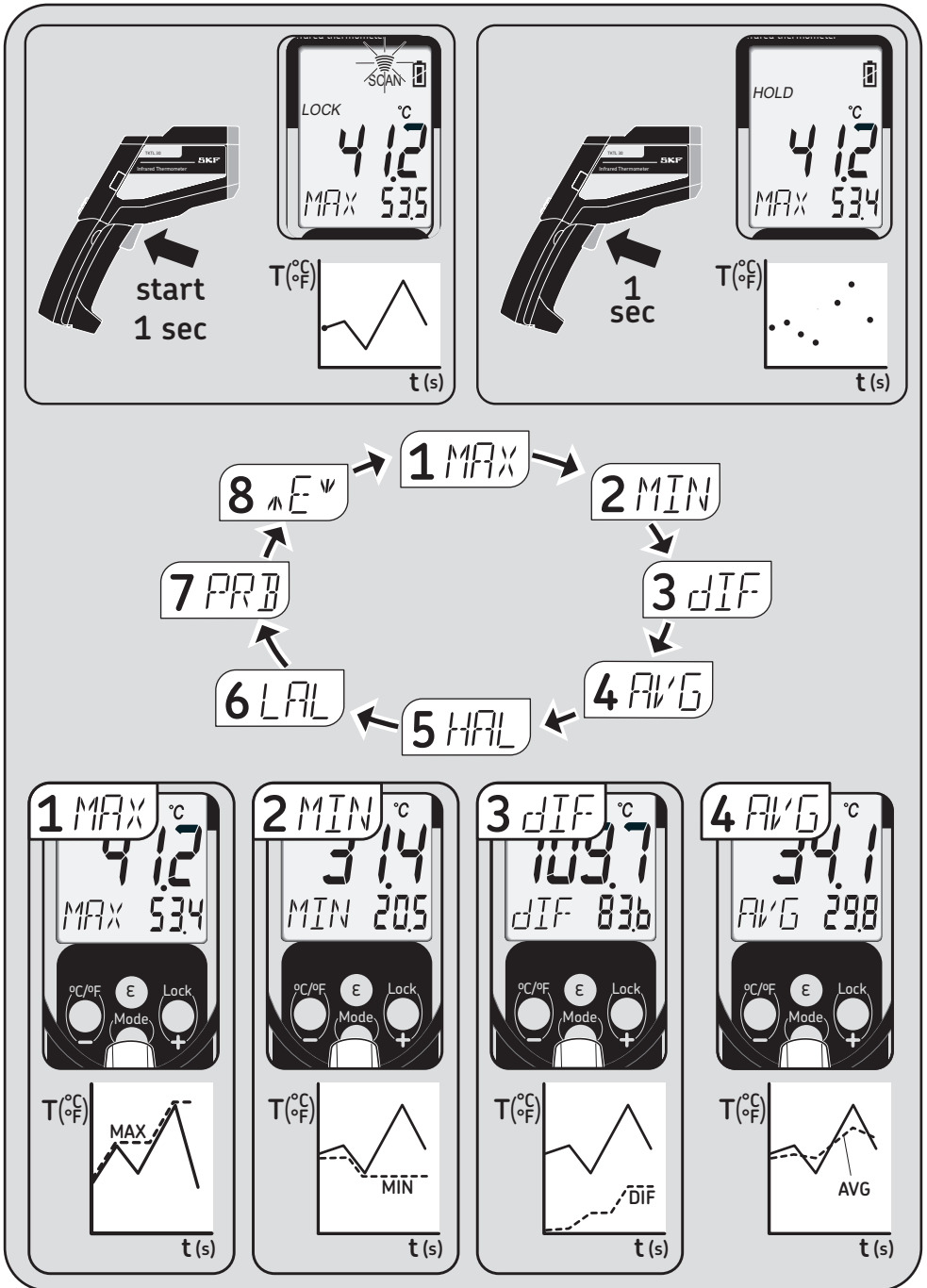

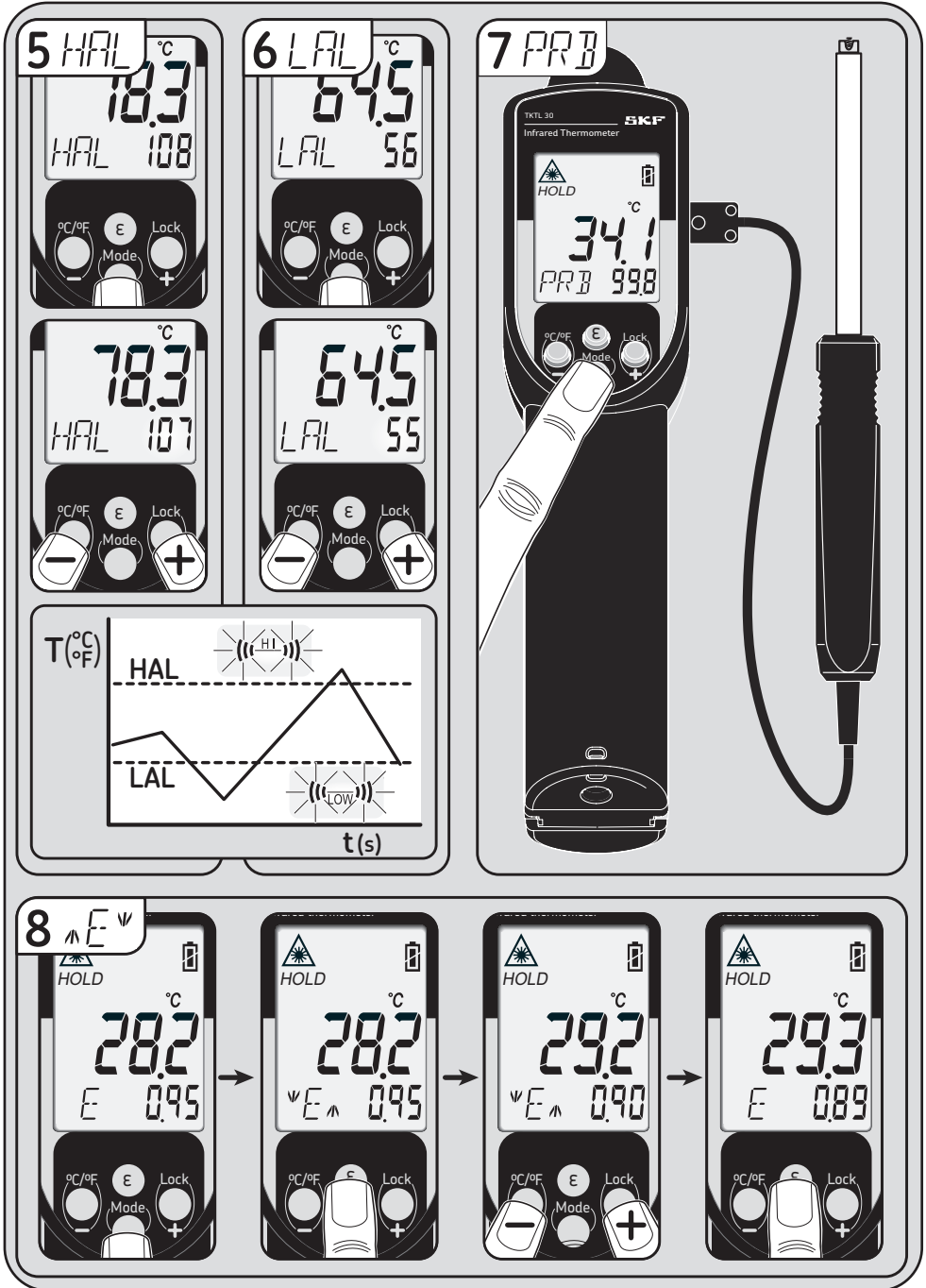



AUTO-OFF ⏴ 1min



AUTO-OFF ⏴ 60min



AUTO-OFF ⏴ 12min

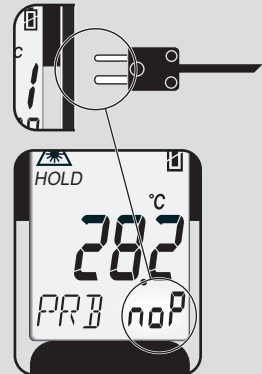
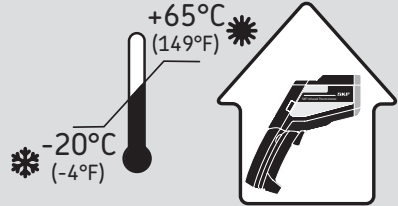
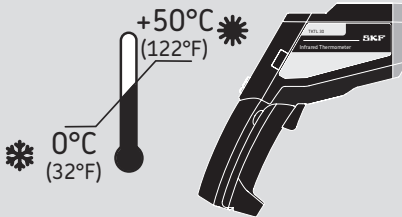
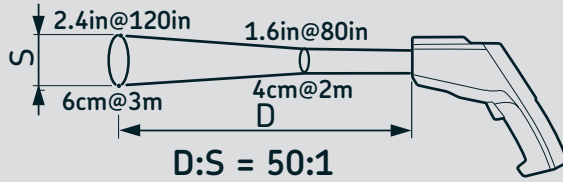
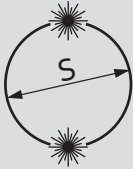

# LOCK

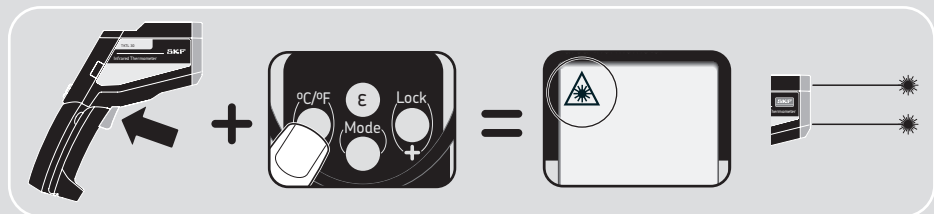
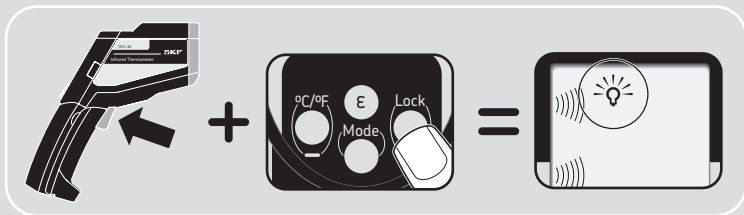
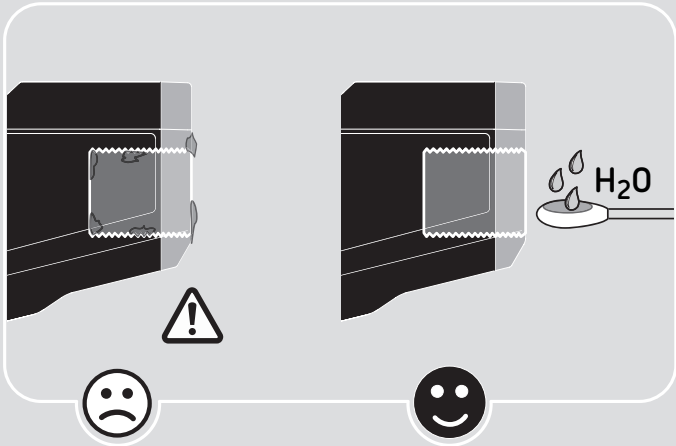

*In line with our policy of continuous development of our products we reserve the right to alter any part of the above specification without prior notice. Although care has been taken to ensure the accuracy of this publication, SKF does not assume any liability for errors or omissions.*

*I overensstemmelse med vor politik for kontinuerlig udvikling af vore produkter forbeholder vi os ret til at ændre på hvilken som helst af de i brochuren nævnte specifikationer, uden at meddele dette i forvejen. Desuden tages der forbehold for eventuelle trykfejl.*

*Gemäß unserer Firmenpolitik der ständigen Weiterentwicklung unserer Produkte behalten wir uns Änderungen der obigen Daten ohne Vorankündigung vor.*

*En línea con nuestra política de constante desarrollo de nuestros productos, nos reservamos el derecho a modificar cualquier parte de las especificaciones sin previa notificación.*

*Conformément à notre politique de développement continu de nos produits, nous nous réservons le droit de modifier, sans préavis, tout ou partie des spécifications ci-dessus.*

*In linea con la nostra politica a di sviluppo continuo dei prodotti ci riserviamo il diritto di apportare modifiche senza preavviso a qualsiasi parte della presente documentazione.*

*In verband met onze politiek van continue ontwikkeling van onze producten, behouden wij ons het recht voor om de specificaties van de vermelde onderdelen te wijzigen zonder nota vooraf.*

*Em linha com a nossa política de desenvolvimento contínuo dos nossos produtos, reservamo-nos o direito de alterar este catálogo sem aviso prévio.*

*Tavoitteenamme on tuotteidemme jatkuva kehittyä. Pidätämme siksi oikeuden etukäteen ilmoittamatta muuttaa yllä olevia erittelyjä.*

*I linje med vår policy för kontinuerlig utveckling av våra produkter förbehåller vi oss rätten att ändra ovanstående specifikationer utan att meddela i förväg.*

*Σύμφωνα με την πολιτική της συνεχούς ανάπτυξης των προϊόντων μας, διατηρούμε το δικαίωμα να αλλάξουμε οποιοδήποτε μέρος των παραπάνω χαρακτηριστικών χωρίς προειδοποίηση.*

## SKF Maintenance Products

© SKF Group 2011/01

[www.mapro.skf.com](http://www.mapro.skf.com)  
[www.skf.com/mount](http://www.skf.com/mount)

MP5382

