

**magnetic field sensor
for pneumatic cylinders
BIM-IKT-AP6X-H1141/S363**

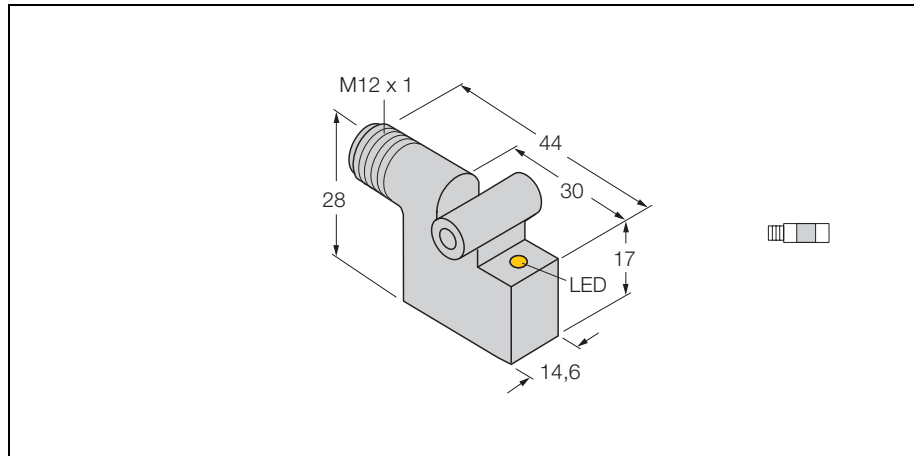

- rectangular, height 28 mm
- metal, GD-Zn
- special coil
- wide overtravel range (min. 25 mm)
- 3-wire DC, 10...30 VDC
- normally open, pnp output
- connector, M12 x 1

Wiring diagram

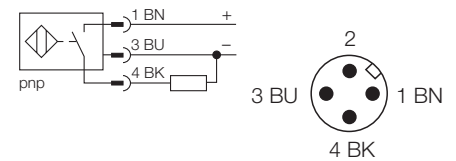

Functional principle

Magnetic field sensors are activated by magnetic fields and are especially suited for piston position detection in pneumatic cylinders. Based on the fact that magnetic fields can permeate non-magnetizable metals, it is possible to detect a permanent magnet attached to the piston through the aluminium wall of the cylinder.

Type	BIM-IKT-AP6X-H1141/S363
Ident-No.	4621001
Pass speed	≤ 10 m/s
Hysteresis	≤ 1 mm
Temperature drift	≤ 0.1 mm
Repeatability	≥ ± 0.1 mm
Ambient temperature	-25...+ 70°C
Operating voltage	10... 30VDC
Residual ripple	≤ 10 % U _{SS}
DC rated operational current	≤ 200 mA
No-load current I ₀	≤ 15 mA
Residual current	≤ 0.1 mA
Switching frequency	≤ 1 kHz
Rated insulation voltage	≤ 0.5 kV
Output function	3-wire, normally open, pnp
Short-circuit protection	yes / cyclic
Voltage drop at I _e	≤ 1.8V
Wire breakage / Reverse polarity protection	yes / complete
Housing	rectangular, IKT
Dimensions	30 x 14.6 x 28 mm
Housing material	metal, GD-Zn
Material active face	plastic, PA12-GF30
Connection	Connectors, M12 x 1
Vibration resistance	55 Hz (1 mm)
Shock resistance	30g (11 ms)
Degree of protection	IP67

Mounting on the following profiles











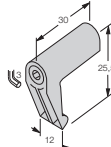

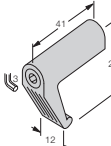

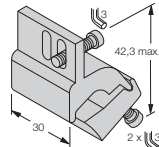
Display switch state

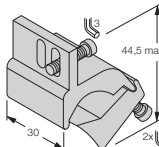
LED yellow

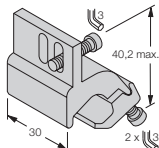
**magnetic field sensor
for pneumatic cylinders
BIM-IKT-AP6X-H1141/S363**

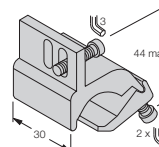
Accessories

Type code	Ident-No.	Short text	Dimension drawing
KLI1	69710	mounting on  tie-rod cylinders; cylinder diameter 32...100 mm; material: die-cast zinc	
KLI3	69712	mounting on  tie-rod cylinders; cylinder diameter 63...160 mm; material: die-cast zinc	
KLI5Z	6971803	mounting on  tie-rod cylinders; cylinder diameter 32...63 mm; material: aluminum	
KLI6Z	6971806	mounting on  tie-rod cylinders; cylinder diameter 50...125 mm; material: aluminum	
KLI5	6971802	mounting on  profile cylinder; cylinder diameter 32...50 mm; material: aluminium	
KLI6	6971805	mounting on  profile cylinder; cylinder diameter 50...100 mm; material: aluminium	
KLI 7	6971810	mounting on  profile cylinders with external dovetail groove; cylinder diameter 32..200 mm; material: aluminium	