



ATTENTION
OBSERVE PRECAUTIONS
FOR HANDLING
ELECTROSTATIC
DISCHARGE
SENSITIVE
DEVICES

Part Number: KA-3535SYL2Z4S

Super Bright Yellow

Features

- White SMD package, silicone resin.
- Low thermal resistance.
- Compatible with IR-reflow processes.
- ESD protection.
- Package: 2000pcs / reel.
- Moisture sensitivity level : level 2a.
- RoHS compliant.

Description

The source color devices are made with AlGaInP Light Emitting Diode.

Static electricity and surge damage the LEDs.

It is recommended to use a wrist band or anti-electrostatic glove when handling the LEDs.

All devices, equipment and machinery must be electrically grounded.

Applications

- Signal and symbol luminaire for orientation.
- Marker lights (e.g. steps, exit ways, etc).
- Decorative and entertainment lighting.
- Commercial and residential lighting.
- Automotive interior lighting.

Package Dimensions

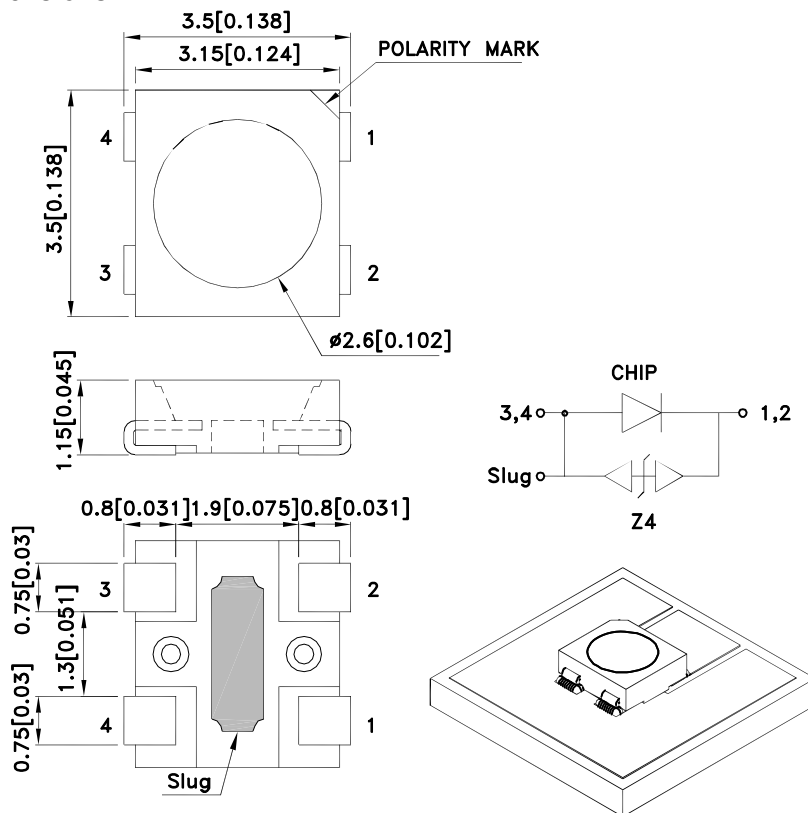

Notes:

1. All dimensions are in millimeters (inches).
2. Tolerance is $\pm 0.25 (0.01")$ unless otherwise noted.
3. The specifications, characteristics and technical data described in the datasheet are subject to change without prior notice.
4. The device has a single mounting surface. The device must be mounted according to the specifications.



Handling Precautions

Compare to epoxy encapsulant that is hard and brittle, silicone is softer and flexible. Although its characteristic significantly reduces thermal stress, it is more susceptible to damage by external mechanical force.

As a result, special handling precautions need to be observed during assembly using silicone encapsulated LED products. Failure to comply might lead to damage and premature failure of the LED.

1. Handle the component along the side surfaces by using forceps or appropriate tools.

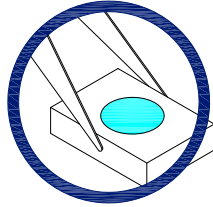

2. Do not directly touch or handle the silicone lens surface. It may damage the internal circuitry.

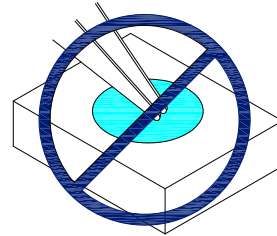
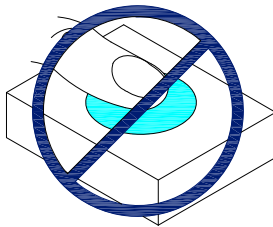

3. Do not stack together assembled PCBs containing exposed LEDs. Impact may scratch the silicone lens or damage the internal circuitry.

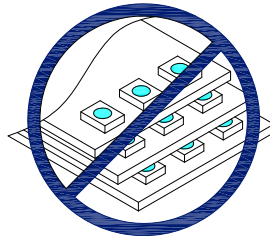

- 4.1. The inner diameter of the SMD pickup nozzle should not exceed the size of the LED to prevent air leaks.
- 4.2. A pliable material is suggested for the nozzle tip to avoid scratching or damaging the LED surface during pickup.
- 4.3. The dimensions of the component must be accurately programmed in the pick-and-place machine to insure precise pickup and avoid damage during production.

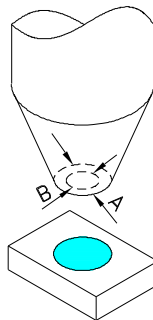

5. As silicone encapsulation is permeable to gases, some corrosive substances such as H_2S might corrode silver plating of leadframe. Special care should be taken if an LED with silicone encapsulation is to be used near such substances.

Selection Guide

Part No.	Dice	Lens Type	Iv (cd) [2] @ 150mA		Φv (lm) [2] @ 150mA*		Viewing Angle [1]
			Min.	Typ.	Min.	Typ.	2 θ 1/2
KA-3535SYL2Z4S	Super Bright Yellow (AlGaInP)	Water Clear	1.6	2.7	10	14	120 °

Notes:

1. θ1/2 is the angle from optical centerline where the luminous intensity is 1/2 of the optical peak value.
2. Luminous intensity/ luminous Flux: +/-15%.*LEDs are binned according to their luminous flux.
3. Luminous intensity/ luminous Flux value is traceable to the CIE127-2007 compliant national standards.

Absolute Maximum Ratings at TA=25°C

Parameter	Symbol	Value	Unit
Power Dissipation	P _D	495	mW
Junction Temperature [1]	T _J	110	°C
Operating Temperature	T _{op}	-40 To +85	°C
Storage Temperature	T _{stg}	-40 To +85	°C
DC Forward Current [1]	I _F	150	mA
Reverse Voltage	V _R	5	V
Peak Forward Current [2]	I _{FM}	270	mA
Thermal Resistance [1] (Junction/ambient)	R _{th j-a}	210	°C/W
Thermal Resistance [1] (Junction/solder point)	R _{th j-s}	70	°C/W
Electrostatic Discharge Threshold (HBM)		8000	V

Notes:

1. Results from mounting on PC board FR4 (pad size ≥ 70mm²), mounted on pc board-metal core PCB is recommend for lowest thermal Resistance.
2. 1/10 Duty Cycle, 0.1ms Pulse Width.

Electrical / Optical Characteristics at TA=25°C

Parameter	Symbol	Value	Unit
Wavelength at peak emission I _F =150mA [Typ.]	λ peak	590	nm
Dominant Wavelength I _F =150mA [Typ.]	λ dom [1]	590	nm
Spectral Line Half-width I _F =150mA [Typ.]	Δλ	20	nm
Forward Voltage I _F =150mA [Min.]	V _F [2]	2.2	V
Forward Voltage I _F =150mA [Typ.]		2.7	
Forward Voltage I _F =150mA [Max.]		3.3	
Allowable Reverse Current [Max.]	I _R	85	mA
Temperature coefficient of λ peak I _F =150mA, -10 ° C ≤ T ≤ 100 ° C [Typ.]	TC λ peak	0.13	nm/° C
Temperature coefficient of λ dom I _F =150mA, -10 ° C ≤ T ≤ 100 ° C [Typ.]	TC λ dom	0.10	nm/° C
Temperature coefficient of V _F I _F =150mA, -10 ° C ≤ T ≤ 100 ° C [Typ.]	TC _V	-1.9	mV/° C

Notes:

1. Wavelength: +/-1nm.
2. Forward Voltage: +/-0.1V.
3. Wavelength value is traceable to the CIE127-2007 compliant national standards.

Super Bright Yellow

KA-3535SYL2Z4S

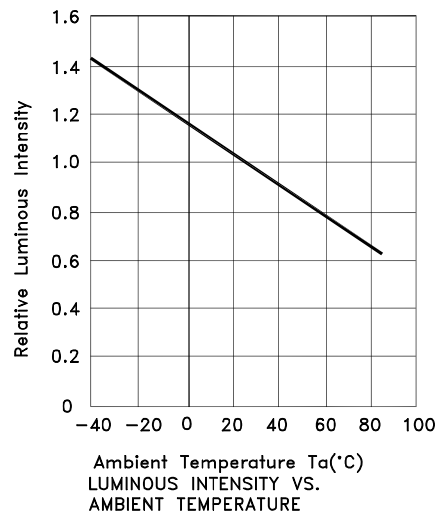
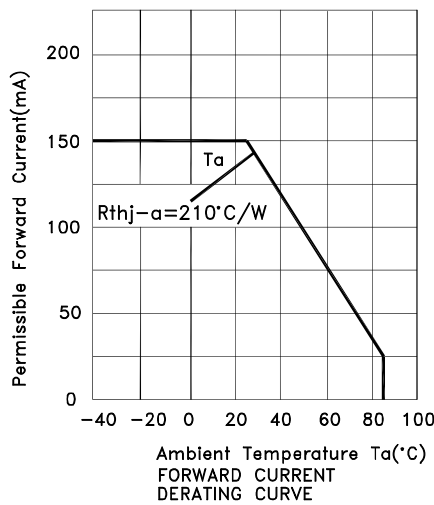
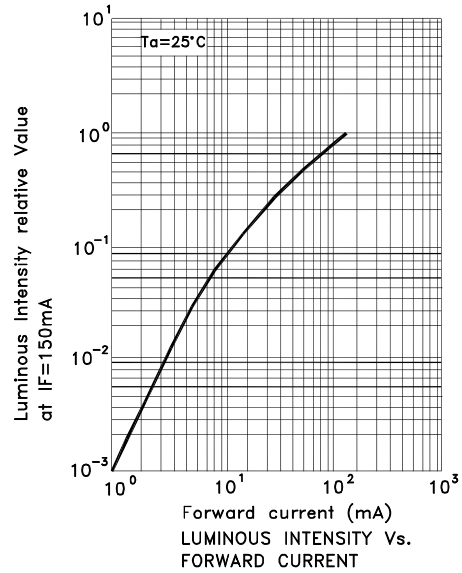
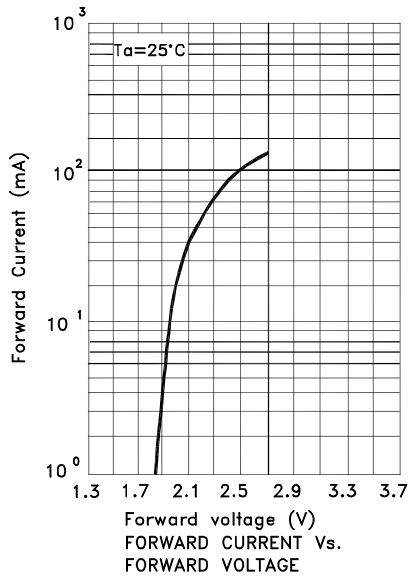
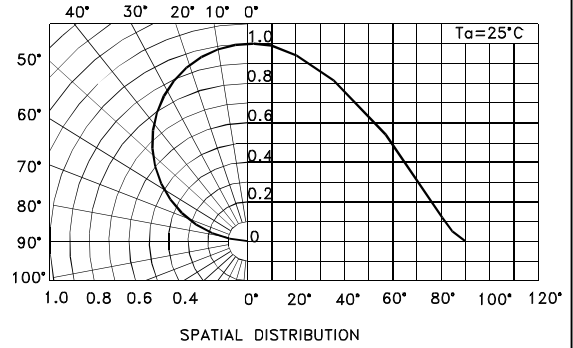
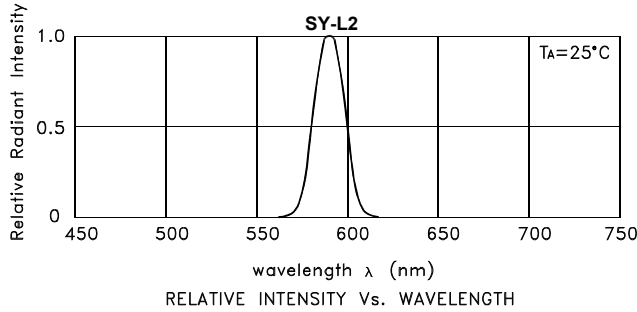

KA-3535SYL2Z4S

Reflow soldering is recommended and the soldering profile is shown below.
Other soldering methods are not recommended as they might cause damage to the product.

Reflow Soldering Profile For Lead-free SMT Process.

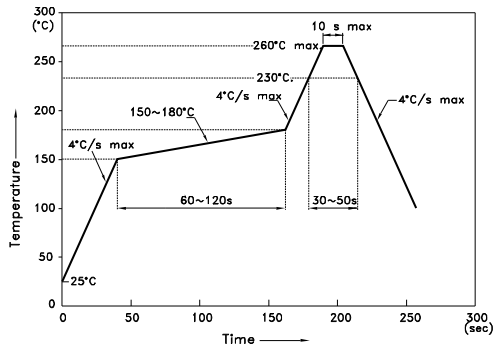

NOTES:

1. We recommend the reflow temperature 245°C(+/-5°C). The maximum soldering temperature should be limited to 260°C.
2. Don't cause stress to the epoxy resin while it is exposed to high temperature.
3. Number of reflow process shall be 2 times or less.

Reel Dimension

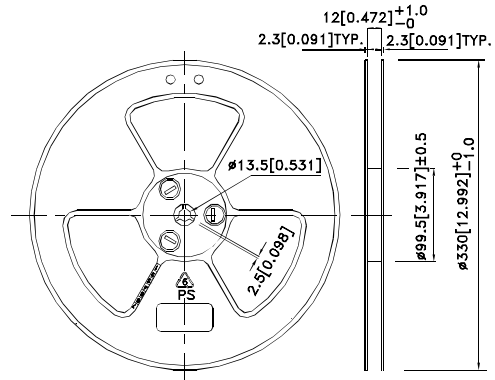

Recommended Soldering Pattern (Units : mm; Tolerance: ±0.1)

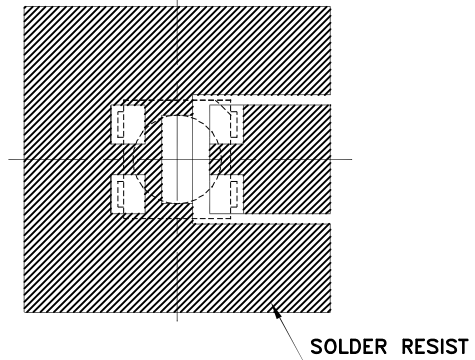
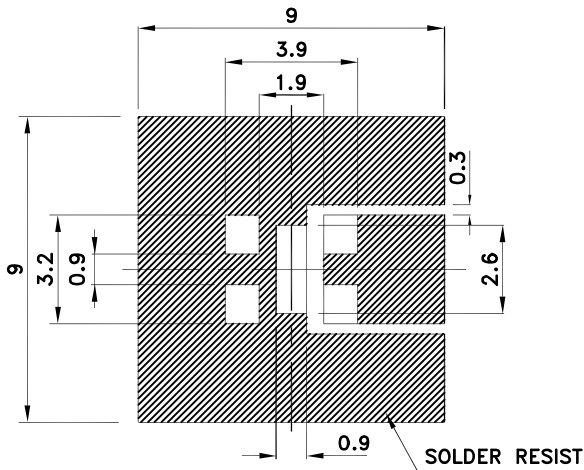

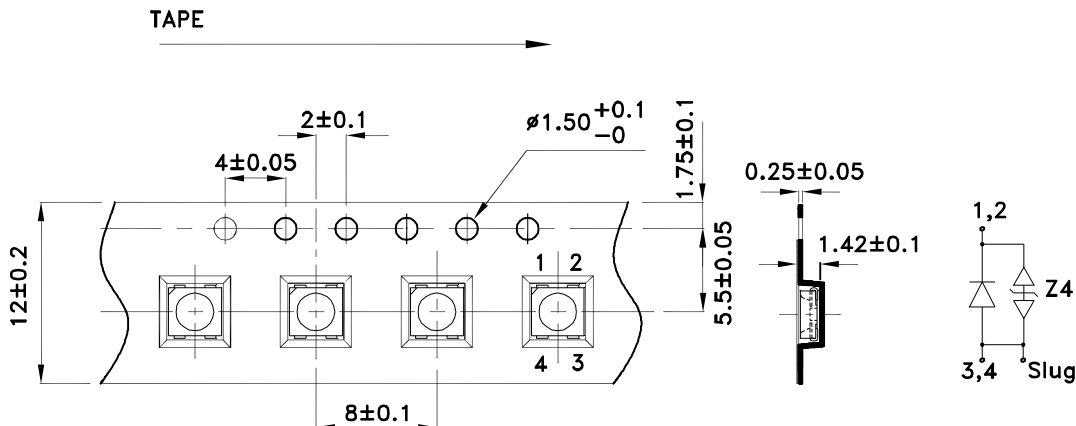

Tape Specifications (Units : mm)

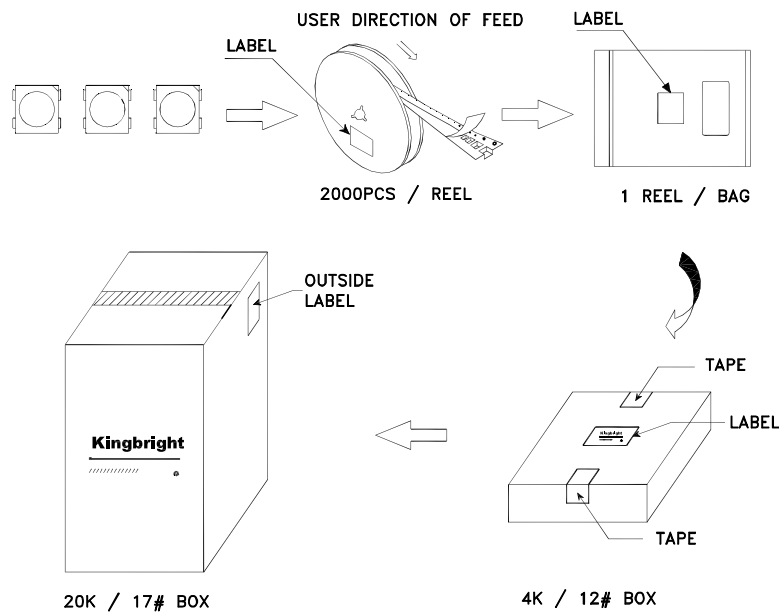

PACKING & LABEL SPECIFICATIONS

KA-3535SYL2Z4S



Kingbright	
P/NO: KA-3535xxx	
QTY: 2000 pcs	Q.C. Q C xx xx xxxx PASSED
S/N: XXXX	
CODE: XXX	
LOT NO:	
	
RoHS Compliant	

Terms and conditions for the usage of this document

- 1.The information included in this document reflects representative usage scenarios and is intended for technical reference only.
- 2.The part number, type, and specifications mentioned in this document are subject to future change and improvement without notice. Before production usage customer should refer to the latest datasheet for the updated specifications.
- 3.When using the products referenced in this document, please make sure the product is being operated within the environmental and electrical limits specified in the datasheet. If customer usage exceeds the specified limits, Kingbright will not be responsible for any subsequent issues.
- 4.The information in this document applies to typical usage in consumer electronics applications. If customer's application has special reliability requirements or have life-threatening liabilities, such as automotive or medical usage, please consult with Kingbright representative for further assistance.
- 5.The contents and information of this document may not be reproduced or re-transmitted without permission by Kingbright.
- 6.All design applications should refer to Kingbright application notes available at http://www.kingbright.com/application_notes