

# Cree® 5mm Round LED

## C513A-WSS/WSN

## C513A-MSS/MSN

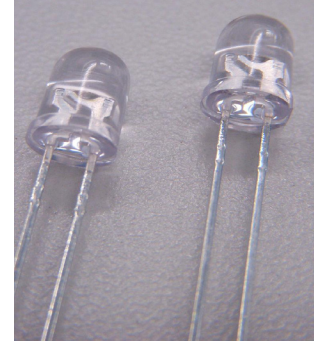

### PRODUCT DESCRIPTION

Round LEDs offer superior light output for excellent readability in sunlight and dependable performance. They provide extremely stable light output over long periods of time.

These lamps are made with an advanced optical grade epoxy offering superior high temperature and high moisture resistance performance in lighting and illumination applications.

### FEATURES

- Size (mm): 5
- Color Temperatures:  
Cool White :  
Min . (4600K) / Typical (9000K)  
Warm White :  
Min . (2500K) / Typical (2800K)
- Luminous Intensity (mcd)  
C513A-WSS/WSN:(3000-12000)  
C513A-MSS/MSN:(2130-8200)
- CRI:  
Typical CRI for Cool White is 75  
Typical CRI for Warm White is 80
- Viewing angle:  
C513A-WSS/WSN: 55 degree  
C513A-MSS/MSN: 55 degree
- Lead-Free
- RoHS Compliant

### APPLICATIONS

- Torch
- Light Strip
- Channel Letter
- Retail Display Lighting

### ABSOLUTE MAXIMUM RATINGS ( $T_A = 25^\circ\text{C}$ )

| Items                                | Symbol    | Absolute Maximum Rating   | Unit             |
|--------------------------------------|-----------|---|------------------|
|                                      |           | Cool/Warm   |                  |
| Forward Current                      | $I_F$     | 30  | mA               |
| Peak Forward Current <sup>Note</sup> | $I_{FP}$  | 100   | mA               |
| Reverse Voltage                      | $V_R$     | 5   | V                |
| Power Dissipation                    | $P_D$     | 120   | mW               |
| Operation Temperature                | $T_{opr}$ | -40 ~ +95   | $^\circ\text{C}$ |
| Storage Temperature                  | $T_{stg}$ | -40 ~ +100  | $^\circ\text{C}$ |
| Lead Soldering Temperature           | $T_{sol}$ | Max. 260 $^\circ\text{C}$ for 3 sec. max.<br>(3 mm from the base of the epoxy bulb) |                  |

**Note:** Pulse width  $\leq 0.1$  msec, duty  $\leq 1/10$ .

### TYPICAL ELECTRICAL & OPTICAL CHARACTERISTICS ( $T_A = 25^\circ\text{C}$ )

| Characteristics          | Color     | Symbol          | Condition     | Unit          | Minimum | Typical | Maximum |
|--------------------------|-----------|-----------------|---------------|---------------|---------|---------|---------|
| Forward Voltage          | Cool/Warm | $V_F$           | $I_F = 20$ mA | V             |         | 3.2     | 4.0     |
| Reverse Current          | Cool/Warm | $I_R$           | $V_R = 5$ V   | $\mu\text{A}$ |         |         | 100     |
| Luminous Intensity       | Cool      | $I_V$           | $I_F = 20$ mA | mcd           | 3000    | 6800    |         |
|                          | Warm      | $I_V$           | $I_F = 20$ mA | mcd           | 2130    | 4500    |         |
| Chromaticity Coordinates | Cool      | x               | $I_F = 20$ mA |               |         | 0.2895  |         |
|                          |           | y               | $I_F = 20$ mA |               |         | 0.2905  |         |
|                          | Warm      | x               | $I_F = 20$ mA |               |         | 0.4527  |         |
|                          |           | y               | $I_F = 20$ mA |               |         | 0.4255  |         |
| 50% Power Angle          | Cool/Warm | $2\theta_{1/2}$ | $I_F = 20$ mA | deg           |         | 55      |         |

### INTENSITY BIN LIMIT ( $I_f = 20 \text{ mA}$ )

#### Cool White(C513A-WSS/WSN)

| Bin Code | Min.(mcd) | Max.(mcd) |
|----------|-----------|-----------|
| W0       | 3000      | 4180      |
| X0       | 4180      | 5860      |
| Y0       | 5860      | 8200      |
| Z0       | 8200      | 12000     |

#### Warm White(C513A-MSS/MSN)

| Bin Code | Min.(mcd) | Max.(mcd) |
|----------|-----------|-----------|
| V0       | 2130      | 3000      |
| W0       | 3000      | 4180      |
| X0       | 4180      | 5860      |
| Y0       | 5860      | 8200      |

- Tolerance of measurement of luminous intensity is  $\pm 15\%$

### VF BIN LIMIT ( $I_f = 20 \text{ mA}$ )

#### Cool White(C513A-WSS/WSN)

| Bin Code | Min.(V) | Max.(V) |
|----------|---------|---------|
| 27       | 2.8     | 3.0     |
| 28       | 3.0     | 3.2     |
| 29       | 3.2     | 3.4     |
| 2a       | 3.4     | 3.6     |
| 2b       | 3.6     | 3.8     |
| 2c       | 3.8     | 4.0     |

#### Warm White(C513A-MSS/MSN)

| Bin Code | Min.(V) | Max.(V) |
|----------|---------|---------|
| 27       | 2.8     | 3.0     |
| 28       | 3.0     | 3.2     |
| 29       | 3.2     | 3.4     |
| 2a       | 3.4     | 3.6     |
| 2b       | 3.6     | 3.8     |
| 2c       | 3.8     | 4.0     |

- Tolerance of measurement of VF is  $\pm 0.05\text{V}$ .

**COLOR BIN LIMIT ( $I_F = 20 \text{ mA}$ )**

Cool White

| Bin Code | Sub-bin | x      | y      |
|----------|---------|--------|--------|
| W1       | Wa1     | 0.2449 | 0.2288 |
|          |         | 0.2497 | 0.2384 |
|          |         | 0.2543 | 0.2356 |
|          |         | 0.2497 | 0.2267 |
|          | Wa2     | 0.2497 | 0.2267 |
|          |         | 0.2543 | 0.2356 |
|          |         | 0.2589 | 0.2328 |
|          |         | 0.2545 | 0.2245 |
|          | Wa3     | 0.2497 | 0.2384 |
|          |         | 0.2545 | 0.2480 |
|          |         | 0.2589 | 0.2445 |
|          |         | 0.2543 | 0.2356 |
|          | Wa4     | 0.2543 | 0.2356 |
|          |         | 0.2589 | 0.2445 |
|          |         | 0.2633 | 0.2410 |
|          |         | 0.2589 | 0.2328 |
|          | Wb1     | 0.2545 | 0.2245 |
|          |         | 0.2589 | 0.2328 |
|          |         | 0.2635 | 0.2299 |
|          |         | 0.2593 | 0.2223 |
|          | Wb2     | 0.2593 | 0.2223 |
|          |         | 0.2635 | 0.2299 |
|          |         | 0.2680 | 0.2270 |
|          |         | 0.2640 | 0.2200 |
|          | Wb3     | 0.2589 | 0.2328 |
|          |         | 0.2633 | 0.2410 |
|          |         | 0.2677 | 0.2375 |
|          |         | 0.2635 | 0.2299 |
| Wb4      | 0.2635  | 0.2299 |        |
|          | 0.2677  | 0.2375 |        |
|          | 0.2720  | 0.2340 |        |
|          | 0.2680  | 0.2270 |        |

| Bin Code | Sub-bin | x      | y      |
|----------|---------|--------|--------|
| W1       | Wc1     | 0.2545 | 0.2480 |
|          |         | 0.2593 | 0.2575 |
|          |         | 0.2635 | 0.2534 |
|          |         | 0.2589 | 0.2445 |
|          | Wc2     | 0.2589 | 0.2445 |
|          |         | 0.2635 | 0.2534 |
|          |         | 0.2677 | 0.2493 |
|          |         | 0.2633 | 0.2410 |
|          | Wc3     | 0.2593 | 0.2575 |
|          |         | 0.2640 | 0.2670 |
|          |         | 0.2680 | 0.2623 |
|          |         | 0.2635 | 0.2534 |
|          | Wc4     | 0.2635 | 0.2534 |
|          |         | 0.2680 | 0.2623 |
|          |         | 0.2720 | 0.2575 |
|          |         | 0.2677 | 0.2493 |
|          | Wd1     | 0.2633 | 0.2410 |
|          |         | 0.2677 | 0.2493 |
|          |         | 0.2718 | 0.2451 |
|          |         | 0.2677 | 0.2375 |
|          | Wd2     | 0.2677 | 0.2375 |
|          |         | 0.2718 | 0.2451 |
|          |         | 0.2760 | 0.2410 |
|          |         | 0.2720 | 0.2340 |
|          | Wd3     | 0.2677 | 0.2493 |
|          |         | 0.2720 | 0.2575 |
|          |         | 0.2760 | 0.2528 |
|          |         | 0.2718 | 0.2451 |
| Wd4      | 0.2718  | 0.2451 |        |
|          | 0.2760  | 0.2528 |        |
|          | 0.2800  | 0.2480 |        |
|          | 0.2760  | 0.2410 |        |

| Bin Code | Sub-bin | x      | y      |
|----------|---------|--------|--------|
| W2       | We1     | 0.2640 | 0.2670 |
|          |         | 0.2688 | 0.2765 |
|          |         | 0.2726 | 0.2711 |
|          |         | 0.2680 | 0.2623 |
|          | We2     | 0.2680 | 0.2623 |
|          |         | 0.2726 | 0.2711 |
|          |         | 0.2764 | 0.2658 |
|          |         | 0.2720 | 0.2575 |
|          | We3     | 0.2688 | 0.2765 |
|          |         | 0.2735 | 0.2860 |
|          |         | 0.2772 | 0.2800 |
|          |         | 0.2726 | 0.2711 |
|          | We4     | 0.2726 | 0.2711 |
|          |         | 0.2772 | 0.2800 |
|          |         | 0.2808 | 0.2740 |
|          |         | 0.2764 | 0.2658 |
|          | Wf1     | 0.2720 | 0.2575 |
|          |         | 0.2764 | 0.2658 |
|          |         | 0.2802 | 0.2604 |
|          |         | 0.2760 | 0.2528 |
|          | Wf2     | 0.2760 | 0.2528 |
|          |         | 0.2802 | 0.2604 |
|          |         | 0.2840 | 0.2550 |
|          |         | 0.2800 | 0.2480 |
|          | Wf3     | 0.2764 | 0.2658 |
|          |         | 0.2808 | 0.2740 |
|          |         | 0.2844 | 0.2680 |
|          |         | 0.2802 | 0.2604 |
| Wf4      | 0.2802  | 0.2604 |        |
|          | 0.2844  | 0.2680 |        |
|          | 0.2880  | 0.2620 |        |
|          | 0.2840  | 0.2550 |        |

- Tolerance of measurement of the color coordinates is  $\pm 0.01$ .

**COLOR BIN LIMIT ( $I_F = 20 \text{ mA}$ )**

Cool White

| Bin Code | Sub-bin | x      | y      |
|----------|---------|--------|--------|
| W2       | Wg1     | 0.2735 | 0.2860 |
|          |         | 0.2783 | 0.2955 |
|          |         | 0.2817 | 0.2889 |
|          |         | 0.2772 | 0.2800 |
|          | Wg2     | 0.2772 | 0.2800 |
|          |         | 0.2817 | 0.2889 |
|          |         | 0.2852 | 0.2823 |
|          |         | 0.2808 | 0.2740 |
|          | Wg3     | 0.2783 | 0.2955 |
|          |         | 0.2830 | 0.3050 |
|          |         | 0.2863 | 0.2978 |
|          |         | 0.2817 | 0.2889 |
|          | Wg4     | 0.2817 | 0.2889 |
|          |         | 0.2863 | 0.2978 |
|          |         | 0.2895 | 0.2905 |
|          |         | 0.2852 | 0.2823 |
|          | Wh1     | 0.2808 | 0.2740 |
|          |         | 0.2852 | 0.2823 |
|          |         | 0.2886 | 0.2756 |
|          |         | 0.2844 | 0.2680 |
|          | Wh2     | 0.2844 | 0.2680 |
|          |         | 0.2886 | 0.2756 |
|          |         | 0.2920 | 0.2690 |
|          |         | 0.2880 | 0.2620 |
|          | Wh3     | 0.2852 | 0.2823 |
|          |         | 0.2895 | 0.2905 |
|          |         | 0.2928 | 0.2833 |
|          |         | 0.2886 | 0.2756 |
| Wh4      | 0.2886  | 0.2756 |        |
|          | 0.2928  | 0.2833 |        |
|          | 0.2960  | 0.2760 |        |
|          | 0.2920  | 0.2690 |        |

| Bin Code | Sub-bin | x      | y      |
|----------|---------|--------|--------|
| W3       | Wj1     | 0.2830 | 0.3050 |
|          |         | 0.2890 | 0.3130 |
|          |         | 0.2918 | 0.3048 |
|          |         | 0.2863 | 0.2978 |
|          | Wj2     | 0.2863 | 0.2978 |
|          |         | 0.2918 | 0.3048 |
|          |         | 0.2947 | 0.2967 |
|          |         | 0.2895 | 0.2905 |
|          | Wj3     | 0.2890 | 0.3130 |
|          |         | 0.2950 | 0.3210 |
|          |         | 0.2974 | 0.3119 |
|          |         | 0.2918 | 0.3048 |
|          | Wj4     | 0.2918 | 0.3048 |
|          |         | 0.2974 | 0.3119 |
|          |         | 0.2998 | 0.3028 |
|          |         | 0.2947 | 0.2967 |
|          | Wk1     | 0.2895 | 0.2905 |
|          |         | 0.2947 | 0.2967 |
|          |         | 0.2975 | 0.2890 |
|          |         | 0.2928 | 0.2833 |
|          | Wk2     | 0.2928 | 0.2833 |
|          |         | 0.2975 | 0.2890 |
|          |         | 0.3003 | 0.2813 |
|          |         | 0.2960 | 0.2760 |
|          | Wk3     | 0.2947 | 0.2967 |
|          |         | 0.2998 | 0.3028 |
|          |         | 0.3022 | 0.2946 |
|          |         | 0.2975 | 0.2890 |
| Wk4      | 0.2975  | 0.2890 |        |
|          | 0.3022  | 0.2946 |        |
|          | 0.3045  | 0.2865 |        |
|          | 0.3003  | 0.2813 |        |

| Bin Code | Sub-bin | x      | y      |
|----------|---------|--------|--------|
| W3       | Wm1     | 0.2950 | 0.3210 |
|          |         | 0.3010 | 0.3290 |
|          |         | 0.3030 | 0.3190 |
|          |         | 0.2974 | 0.3119 |
|          | Wm2     | 0.2974 | 0.3119 |
|          |         | 0.3030 | 0.3190 |
|          |         | 0.3050 | 0.3090 |
|          |         | 0.2998 | 0.3028 |
|          | Wm3     | 0.3010 | 0.3290 |
|          |         | 0.3070 | 0.3370 |
|          |         | 0.3085 | 0.3260 |
|          |         | 0.3030 | 0.3190 |
|          | Wm4     | 0.3030 | 0.3190 |
|          |         | 0.3085 | 0.3260 |
|          |         | 0.3100 | 0.3150 |
|          |         | 0.3050 | 0.3090 |
|          | Wn1     | 0.2998 | 0.3028 |
|          |         | 0.3050 | 0.3090 |
|          |         | 0.3070 | 0.3005 |
|          |         | 0.3022 | 0.2946 |
|          | Wn2     | 0.3022 | 0.2946 |
|          |         | 0.3070 | 0.3005 |
|          |         | 0.3090 | 0.2920 |
|          |         | 0.3045 | 0.2865 |
|          | Wn3     | 0.3050 | 0.3090 |
|          |         | 0.3100 | 0.3150 |
|          |         | 0.3115 | 0.3060 |
|          |         | 0.3070 | 0.3005 |
| Wn4      | 0.3070  | 0.3005 |        |
|          | 0.3115  | 0.3060 |        |
|          | 0.3130  | 0.2970 |        |
|          | 0.3090  | 0.2920 |        |

• Tolerance of measurement of the color coordinates is  $\pm 0.01$ .

## COLOR BIN LIMIT ( $I_F = 20 \text{ mA}$ )

Cool White

| Bin Code | Sub-bin | x      | y      |
|----------|---------|--------|--------|
| W4       | Wp1     | 0.3070 | 0.3370 |
|          |         | 0.3130 | 0.3430 |
|          |         | 0.3140 | 0.3320 |
|          |         | 0.3085 | 0.3260 |
|          | Wp2     | 0.3085 | 0.3260 |
|          |         | 0.3140 | 0.3320 |
|          |         | 0.3150 | 0.3210 |
|          |         | 0.3100 | 0.3150 |
|          | Wp3     | 0.3130 | 0.3430 |
|          |         | 0.3190 | 0.3490 |
|          |         | 0.3195 | 0.3380 |
|          |         | 0.3140 | 0.3320 |
|          | Wp4     | 0.3140 | 0.3320 |
|          |         | 0.3195 | 0.3380 |
|          |         | 0.3200 | 0.3270 |
|          |         | 0.3150 | 0.3210 |
|          | Wq1     | 0.3100 | 0.3150 |
|          |         | 0.3150 | 0.3210 |
|          |         | 0.3163 | 0.3118 |
|          |         | 0.3115 | 0.3060 |
|          | Wq2     | 0.3115 | 0.3060 |
|          |         | 0.3163 | 0.3118 |
|          |         | 0.3175 | 0.3025 |
|          |         | 0.3130 | 0.2970 |
|          | Wq3     | 0.3150 | 0.3210 |
|          |         | 0.3200 | 0.3270 |
|          |         | 0.3210 | 0.3175 |
|          |         | 0.3163 | 0.3118 |
|          | Wq4     | 0.3163 | 0.3118 |
|          |         | 0.3210 | 0.3175 |
|          |         | 0.3220 | 0.3080 |
|          |         | 0.3175 | 0.3025 |

| Bin Code | Sub-bin | x      | y      |
|----------|---------|--------|--------|
| W4       | Wr1     | 0.3190 | 0.3490 |
|          |         | 0.3245 | 0.3545 |
|          |         | 0.3248 | 0.3438 |
|          |         | 0.3195 | 0.3380 |
|          | Wr2     | 0.3195 | 0.3380 |
|          |         | 0.3248 | 0.3438 |
|          |         | 0.3250 | 0.3330 |
|          |         | 0.3200 | 0.3270 |
|          | Wr3     | 0.3245 | 0.3545 |
|          |         | 0.3300 | 0.3600 |
|          |         | 0.3300 | 0.3495 |
|          |         | 0.3248 | 0.3438 |
|          | Wr4     | 0.3248 | 0.3438 |
|          |         | 0.3300 | 0.3495 |
|          |         | 0.3300 | 0.3390 |
|          |         | 0.3250 | 0.3330 |
|          | Ws1     | 0.3200 | 0.3270 |
|          |         | 0.3250 | 0.3330 |
|          |         | 0.3255 | 0.3230 |
|          |         | 0.3210 | 0.3175 |
|          | Ws2     | 0.3210 | 0.3175 |
|          |         | 0.3255 | 0.3230 |
|          |         | 0.3260 | 0.3130 |
|          |         | 0.3220 | 0.3080 |
|          | Ws3     | 0.3250 | 0.3330 |
|          |         | 0.3300 | 0.3390 |
|          |         | 0.3300 | 0.3285 |
|          |         | 0.3255 | 0.3230 |
| Ws4      | 0.3255  | 0.3230 |        |
|          | 0.3300  | 0.3285 |        |
|          | 0.3300  | 0.3180 |        |
|          | 0.3260  | 0.3130 |        |

| Bin Code | Sub-bin | x      | y      |
|----------|---------|--------|--------|
| W5       | Wt1     | 0.3300 | 0.3600 |
|          |         | 0.3378 | 0.3663 |
|          |         | 0.3375 | 0.3563 |
|          |         | 0.3300 | 0.3495 |
|          | Wt2     | 0.3300 | 0.3495 |
|          |         | 0.3375 | 0.3563 |
|          |         | 0.3372 | 0.3463 |
|          |         | 0.3300 | 0.3390 |
|          | Wt3     | 0.3378 | 0.3663 |
|          |         | 0.3455 | 0.3725 |
|          |         | 0.3449 | 0.3630 |
|          |         | 0.3375 | 0.3563 |
|          | Wt4     | 0.3375 | 0.3563 |
|          |         | 0.3449 | 0.3630 |
|          |         | 0.3443 | 0.3535 |
|          |         | 0.3372 | 0.3463 |
|          | Wu1     | 0.3300 | 0.3390 |
|          |         | 0.3372 | 0.3463 |
|          |         | 0.3368 | 0.3363 |
|          |         | 0.3300 | 0.3285 |
|          | Wu2     | 0.3300 | 0.3285 |
|          |         | 0.3368 | 0.3363 |
|          |         | 0.3365 | 0.3263 |
|          |         | 0.3300 | 0.3180 |
|          | Wu3     | 0.3372 | 0.3463 |
|          |         | 0.3443 | 0.3535 |
|          |         | 0.3437 | 0.3440 |
|          |         | 0.3368 | 0.3363 |
| Wu4      | 0.3368  | 0.3363 |        |
|          | 0.3437  | 0.3440 |        |
|          | 0.3430  | 0.3345 |        |
|          | 0.3365  | 0.3263 |        |

- Tolerance of measurement of the color coordinates is  $\pm 0.01$ .

## COLOR BIN LIMIT ( $I_f = 20 \text{ mA}$ )

Cool White

| Bin Code | Sub-bin | x      | y      |
|----------|---------|--------|--------|
| W5       | Wv1     | 0.3455 | 0.3725 |
|          |         | 0.3533 | 0.3788 |
|          |         | 0.3523 | 0.3698 |
|          |         | 0.3449 | 0.3630 |
|          | Wv2     | 0.3449 | 0.3630 |
|          |         | 0.3523 | 0.3698 |
|          |         | 0.3514 | 0.3608 |
|          |         | 0.3443 | 0.3535 |
|          | Wv3     | 0.3533 | 0.3788 |
|          |         | 0.3610 | 0.3850 |
|          |         | 0.3598 | 0.3765 |
|          |         | 0.3523 | 0.3698 |
|          | Wv4     | 0.3523 | 0.3698 |
|          |         | 0.3598 | 0.3765 |
|          |         | 0.3585 | 0.3680 |
|          |         | 0.3514 | 0.3608 |
|          | Ww1     | 0.3443 | 0.3535 |
|          |         | 0.3514 | 0.3608 |
|          |         | 0.3505 | 0.3518 |
|          |         | 0.3437 | 0.3440 |
|          | Ww2     | 0.3437 | 0.3440 |
|          |         | 0.3505 | 0.3518 |
|          |         | 0.3495 | 0.3428 |
|          |         | 0.3430 | 0.3345 |
|          | Ww3     | 0.3514 | 0.3608 |
|          |         | 0.3585 | 0.3680 |
|          |         | 0.3573 | 0.3595 |
|          |         | 0.3505 | 0.3518 |
| Ww4      | 0.3505  | 0.3518 |        |
|          | 0.3573  | 0.3595 |        |
|          | 0.3560  | 0.3510 |        |
|          | 0.3495  | 0.3428 |        |

- Tolerance of measurement of the color coordinates is  $\pm 0.01$ .

## COLOR BIN LIMIT ( $I_f = 20 \text{ mA}$ )

Warm White

| Bin Code | Sub-bin | x      | y      |
|----------|---------|--------|--------|
| M1       | Ma1     | 0.3610 | 0.3900 |
|          |         | 0.3715 | 0.3987 |
|          |         | 0.3689 | 0.3853 |
|          |         | 0.3593 | 0.3776 |
|          | Ma2     | 0.3715 | 0.3987 |
|          |         | 0.3820 | 0.4075 |
|          |         | 0.3786 | 0.3929 |
|          |         | 0.3689 | 0.3853 |
|          | Ma3     | 0.3689 | 0.3853 |
|          |         | 0.3786 | 0.3929 |
|          |         | 0.3751 | 0.3783 |
|          |         | 0.3664 | 0.3717 |
|          | Ma4     | 0.3593 | 0.3776 |
|          |         | 0.3689 | 0.3853 |
|          |         | 0.3664 | 0.3717 |
|          |         | 0.3576 | 0.3651 |
|          | Mb1     | 0.3576 | 0.3651 |
|          |         | 0.3664 | 0.3717 |
|          |         | 0.3638 | 0.3582 |
|          |         | 0.3559 | 0.3526 |
|          | Mb2     | 0.3664 | 0.3717 |
|          |         | 0.3751 | 0.3783 |
|          |         | 0.3717 | 0.3637 |
|          |         | 0.3638 | 0.3582 |
|          | Mb3     | 0.3638 | 0.3582 |
|          |         | 0.3717 | 0.3637 |
|          |         | 0.3682 | 0.3491 |
|          |         | 0.3612 | 0.3446 |
|          | Mb4     | 0.3559 | 0.3526 |
|          |         | 0.3638 | 0.3582 |
|          |         | 0.3612 | 0.3446 |
|          |         | 0.3541 | 0.3401 |

| Bin Code | Sub-bin | x      | y      |
|----------|---------|--------|--------|
| M1       | Mc1     | 0.3820 | 0.4075 |
|          |         | 0.3925 | 0.4163 |
|          |         | 0.3882 | 0.4006 |
|          |         | 0.3786 | 0.3929 |
|          | Mc2     | 0.3925 | 0.4163 |
|          |         | 0.4030 | 0.4250 |
|          |         | 0.3978 | 0.4083 |
|          |         | 0.3882 | 0.4006 |
|          | Mc3     | 0.3882 | 0.4006 |
|          |         | 0.3978 | 0.4083 |
|          |         | 0.3926 | 0.3915 |
|          |         | 0.3839 | 0.3849 |
|          | Mc4     | 0.3786 | 0.3929 |
|          |         | 0.3882 | 0.4006 |
|          |         | 0.3839 | 0.3849 |
|          |         | 0.3751 | 0.3783 |
|          | Md1     | 0.3751 | 0.3783 |
|          |         | 0.3839 | 0.3849 |
|          |         | 0.3796 | 0.3693 |
|          |         | 0.3717 | 0.3637 |
|          | Md2     | 0.3839 | 0.3849 |
|          |         | 0.3926 | 0.3915 |
|          |         | 0.3874 | 0.3748 |
|          |         | 0.3796 | 0.3693 |
|          | Md3     | 0.3796 | 0.3693 |
|          |         | 0.3874 | 0.3748 |
|          |         | 0.3822 | 0.3580 |
|          |         | 0.3752 | 0.3536 |
| Md4      | 0.3717  | 0.3637 |        |
|          | 0.3796  | 0.3693 |        |
|          | 0.3752  | 0.3536 |        |
|          | 0.3682  | 0.3491 |        |

| Bin Code | Sub-bin | x      | y      |
|----------|---------|--------|--------|
| M2       | Me1     | 0.4030 | 0.4250 |
|          |         | 0.4145 | 0.4320 |
|          |         | 0.4084 | 0.4145 |
|          |         | 0.3978 | 0.4083 |
|          | Me2     | 0.4145 | 0.4320 |
|          |         | 0.4260 | 0.4390 |
|          |         | 0.4189 | 0.4206 |
|          |         | 0.4084 | 0.4145 |
|          | Me3     | 0.4084 | 0.4145 |
|          |         | 0.4189 | 0.4206 |
|          |         | 0.4118 | 0.4021 |
|          |         | 0.4022 | 0.3968 |
|          | Me4     | 0.3978 | 0.4083 |
|          |         | 0.4084 | 0.4145 |
|          |         | 0.4022 | 0.3968 |
|          |         | 0.3926 | 0.3915 |
|          | Mf1     | 0.3926 | 0.3915 |
|          |         | 0.4022 | 0.3968 |
|          |         | 0.3961 | 0.3793 |
|          |         | 0.3874 | 0.3748 |
|          | Mf2     | 0.4022 | 0.3968 |
|          |         | 0.4118 | 0.4021 |
|          |         | 0.4047 | 0.3837 |
|          |         | 0.3961 | 0.3793 |
|          | Mf3     | 0.3961 | 0.3793 |
|          |         | 0.4047 | 0.3837 |
|          |         | 0.3976 | 0.3653 |
|          |         | 0.3899 | 0.3617 |
| Mf4      | 0.3874  | 0.3748 |        |
|          | 0.3961  | 0.3793 |        |
|          | 0.3899  | 0.3617 |        |
|          | 0.3822  | 0.3580 |        |

- Tolerance of measurement of the color coordinates is  $\pm 0.01$ .

**COLOR BIN LIMIT ( $I_F = 20 \text{ mA}$ )**

Warm White

| Bin Code | Sub-bin | x      | y      |
|----------|---------|--------|--------|
| M2       | Mg1     | 0.4260 | 0.4390 |
|          |         | 0.4375 | 0.4460 |
|          |         | 0.4295 | 0.4268 |
|          |         | 0.4189 | 0.4206 |
|          | Mg2     | 0.4375 | 0.4460 |
|          |         | 0.4490 | 0.4530 |
|          |         | 0.4400 | 0.4329 |
|          |         | 0.4295 | 0.4268 |
|          | Mg3     | 0.4295 | 0.4268 |
|          |         | 0.4400 | 0.4329 |
|          |         | 0.4310 | 0.4128 |
|          |         | 0.4214 | 0.4075 |
|          | Mg4     | 0.4189 | 0.4206 |
|          |         | 0.4295 | 0.4268 |
|          |         | 0.4214 | 0.4075 |
|          |         | 0.4118 | 0.4021 |
|          | Mh1     | 0.4118 | 0.4021 |
|          |         | 0.4214 | 0.4075 |
|          |         | 0.4134 | 0.3882 |
|          |         | 0.4047 | 0.3837 |
|          | Mh2     | 0.4214 | 0.4075 |
|          |         | 0.4310 | 0.4128 |
|          |         | 0.4220 | 0.3927 |
|          |         | 0.4134 | 0.3882 |
|          | Mh3     | 0.4134 | 0.3882 |
|          |         | 0.4220 | 0.3927 |
|          |         | 0.4129 | 0.3725 |
|          |         | 0.4053 | 0.3689 |
| Mh4      | 0.4047  | 0.3837 |        |
|          | 0.4134  | 0.3882 |        |
|          | 0.4053  | 0.3689 |        |
|          | 0.3976  | 0.3653 |        |

| Bin Code | Sub-bin | x      | y      |
|----------|---------|--------|--------|
| M3       | Mj1     | 0.4490 | 0.4530 |
|          |         | 0.4638 | 0.4578 |
|          |         | 0.4540 | 0.4372 |
|          |         | 0.4400 | 0.4329 |
|          | Mj2     | 0.4638 | 0.4578 |
|          |         | 0.4785 | 0.4625 |
|          |         | 0.4679 | 0.4414 |
|          |         | 0.4540 | 0.4372 |
|          | Mj3     | 0.4540 | 0.4372 |
|          |         | 0.4679 | 0.4414 |
|          |         | 0.4572 | 0.4203 |
|          |         | 0.4441 | 0.4166 |
|          | Mj4     | 0.4400 | 0.4329 |
|          |         | 0.4540 | 0.4372 |
|          |         | 0.4441 | 0.4166 |
|          |         | 0.4310 | 0.4128 |
|          | Mk1     | 0.4310 | 0.4128 |
|          |         | 0.4441 | 0.4166 |
|          |         | 0.4343 | 0.3960 |
|          |         | 0.4220 | 0.3927 |
|          | Mk2     | 0.4441 | 0.4166 |
|          |         | 0.4572 | 0.4203 |
|          |         | 0.4466 | 0.3993 |
|          |         | 0.4343 | 0.3960 |
|          | Mk3     | 0.4343 | 0.3960 |
|          |         | 0.4466 | 0.3993 |
|          |         | 0.4359 | 0.3782 |
|          |         | 0.4244 | 0.3754 |
| Mk4      | 0.4220  | 0.3927 |        |
|          | 0.4343  | 0.3960 |        |
|          | 0.4244  | 0.3754 |        |
|          | 0.4129  | 0.3726 |        |

| Bin Code | Sub-bin | x      | y      |
|----------|---------|--------|--------|
| M3       | Mm1     | 0.4785 | 0.4625 |
|          |         | 0.4933 | 0.4673 |
|          |         | 0.4818 | 0.4457 |
|          |         | 0.4679 | 0.4414 |
|          | Mm2     | 0.4933 | 0.4673 |
|          |         | 0.5080 | 0.4720 |
|          |         | 0.4957 | 0.4500 |
|          |         | 0.4818 | 0.4457 |
|          | Mm3     | 0.4818 | 0.4457 |
|          |         | 0.4957 | 0.4500 |
|          |         | 0.4834 | 0.4279 |
|          |         | 0.4703 | 0.4241 |
|          | Mm4     | 0.4679 | 0.4414 |
|          |         | 0.4818 | 0.4457 |
|          |         | 0.4703 | 0.4241 |
|          |         | 0.4572 | 0.4203 |
|          | Mn1     | 0.4572 | 0.4203 |
|          |         | 0.4703 | 0.4241 |
|          |         | 0.4589 | 0.4026 |
|          |         | 0.4466 | 0.3993 |
|          | Mn2     | 0.4703 | 0.4241 |
|          |         | 0.4834 | 0.4279 |
|          |         | 0.4711 | 0.4059 |
|          |         | 0.4589 | 0.4026 |
|          | Mn3     | 0.4589 | 0.4026 |
|          |         | 0.4711 | 0.4059 |
|          |         | 0.4588 | 0.3838 |
|          |         | 0.4474 | 0.3810 |
| Mn4      | 0.4466  | 0.3993 |        |
|          | 0.4589  | 0.4026 |        |
|          | 0.4474  | 0.3810 |        |
|          | 0.4359  | 0.3782 |        |

- Tolerance of measurement of the color coordinates is  $\pm 0.01$ .

### CIE CHROMATICITY DIAGRAM

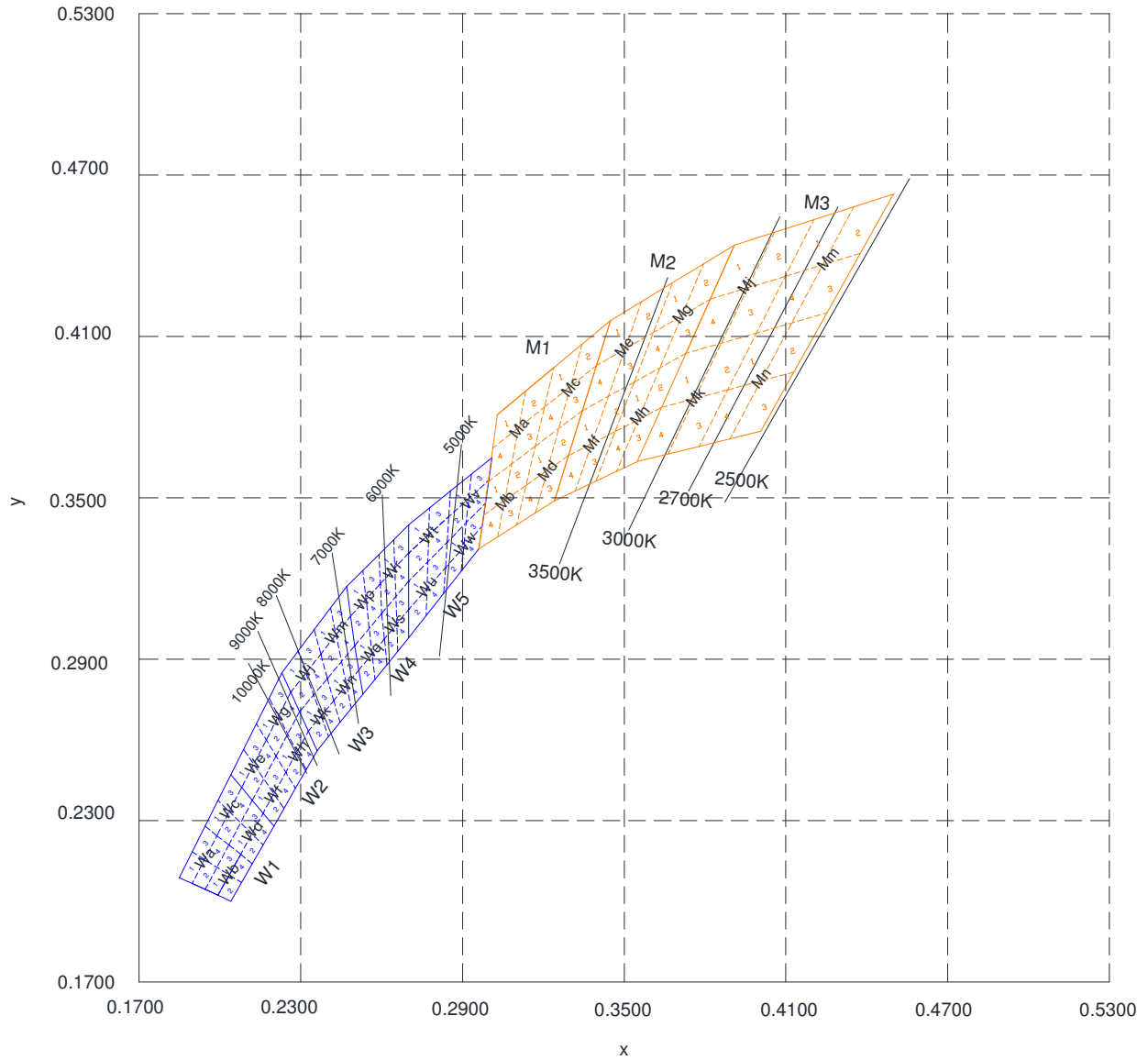

## ORDER CODE TABLE\*

### Cool White

| Color      | Kit Number         | Viewing Angle | Luminous Intensity (mcd) |       | Color Bin Code | Package | Standoff |
|------------|--------------------|---------------|--------------------------|-------|----------------|---------|----------|
|            |                    |               | Min.                     | Max.  |                |         |          |
| Cool White | C513A-WSS-CW0Z0151 | 55            | 3000                     | 12000 | W1,W2,W3,W4,W5 | Bulk    | Yes      |
| Cool White | C513A-WSS-CX0Z0231 | 55            | 4180                     | 12000 | W2,W3          | Bulk    | Yes      |
| Cool White | C513A-WSS-CX0Z0341 | 55            | 4180                     | 12000 | W3,W4          | Bulk    | Yes      |
| Cool White | C513A-WSS-CY0Z0231 | 55            | 5860                     | 12000 | W2,W3          | Bulk    | Yes      |
| Cool White | C513A-WSS-CY0Z0341 | 55            | 5860                     | 12000 | W3,W4          | Bulk    | Yes      |
| Cool White | C513A-WSS-CW0Z0152 | 55            | 3000                     | 12000 | W1,W2,W3,W4,W5 | Ammo    | Yes      |
| Cool White | C513A-WSS-CX0Z0232 | 55            | 4180                     | 12000 | W2,W3          | Ammo    | Yes      |
| Cool White | C513A-WSS-CX0Z0342 | 55            | 4180                     | 12000 | W3,W4          | Ammo    | Yes      |
| Cool White | C513A-WSS-CY0Z0232 | 55            | 5860                     | 12000 | W2,W3          | Ammo    | Yes      |
| Cool White | C513A-WSS-CY0Z0342 | 55            | 5860                     | 12000 | W3,W4          | Ammo    | Yes      |
| Cool White | C513A-WSN-CW0Z0151 | 55            | 3000                     | 12000 | W1,W2,W3,W4,W5 | Bulk    | No       |
| Cool White | C513A-WSN-CX0Z0231 | 55            | 4180                     | 12000 | W2,W3          | Bulk    | No       |
| Cool White | C513A-WSN-CX0Z0341 | 55            | 4180                     | 12000 | W3,W4          | Bulk    | No       |
| Cool White | C513A-WSN-CY0Z0231 | 55            | 5860                     | 12000 | W2,W3          | Bulk    | No       |
| Cool White | C513A-WSN-CY0Z0341 | 55            | 5860                     | 12000 | W3,W4          | Bulk    | No       |
| Cool White | C513A-WSN-CW0Z0152 | 55            | 3000                     | 12000 | W1,W2,W3,W4,W5 | Ammo    | No       |
| Cool White | C513A-WSN-CX0Z0232 | 55            | 4180                     | 12000 | W2,W3          | Ammo    | No       |
| Cool White | C513A-WSN-CX0Z0342 | 55            | 4180                     | 12000 | W3,W4          | Ammo    | No       |
| Cool White | C513A-WSN-CY0Z0232 | 55            | 5860                     | 12000 | W2,W3          | Ammo    | No       |
| Cool White | C513A-WSN-CY0Z0342 | 55            | 5860                     | 12000 | W3,W4          | Ammo    | No       |

## ORDER CODE TABLE\*

### Warm White

| Color      | Kit Number         | Viewing Angle | Luminous Intensity (mcd) |      | Color Bin Code | Package | Standoff |
|------------|--------------------|---------------|--------------------------|------|----------------|---------|----------|
|            |                    |               | Min.                     | Max. |                |         |          |
| Warm White | C513A-MSS-CV0Y0131 | 55            | 2130                     | 8200 | M1,M2,M3       | Bulk    | Yes      |
| Warm White | C513A-MSS-CV0Y0231 | 55            | 2130                     | 8200 | M2,M3          | Bulk    | Yes      |
| Warm White | C513A-MSS-CW0Y0231 | 55            | 3000                     | 8200 | M2,M3          | Bulk    | Yes      |
| Warm White | C513A-MSS-CV0Y0511 | 55            | 2130                     | 8200 | W5,M1          | Bulk    | Yes      |
| Warm White | C513A-MSS-CW0Y0511 | 55            | 3000                     | 8200 | W5,M1          | Bulk    | Yes      |
| Warm White | C513A-MSS-CV0Y0132 | 55            | 2130                     | 8200 | M1,M2,M3       | Ammo    | Yes      |
| Warm White | C513A-MSS-CV0Y0232 | 55            | 2130                     | 8200 | M2,M3          | Ammo    | Yes      |
| Warm White | C513A-MSS-CW0Y0232 | 55            | 3000                     | 8200 | M2,M3          | Ammo    | Yes      |
| Warm White | C513A-MSS-CV0Y0512 | 55            | 2130                     | 8200 | W5,M1          | Ammo    | Yes      |
| Warm White | C513A-MSS-CW0Y0512 | 55            | 3000                     | 8200 | W5,M1          | Ammo    | Yes      |
| Warm White | C513A-MSN-CV0Y0131 | 55            | 2130                     | 8200 | M1,M2,M3       | Bulk    | No       |
| Warm White | C513A-MSN-CV0Y0231 | 55            | 2130                     | 8200 | M2,M3          | Bulk    | No       |
| Warm White | C513A-MSN-CW0Y0231 | 55            | 3000                     | 8200 | M2,M3          | Bulk    | No       |
| Warm White | C513A-MSN-CV0Y0511 | 55            | 2130                     | 8200 | W5,M1          | Bulk    | No       |
| Warm White | C513A-MSN-CW0Y0511 | 55            | 3000                     | 8200 | W5,M1          | Bulk    | No       |
| Warm White | C513A-MSN-CV0Y0132 | 55            | 2130                     | 8200 | M1,M2,M3       | Ammo    | No       |
| Warm White | C513A-MSN-CV0Y0232 | 55            | 2130                     | 8200 | M2,M3          | Ammo    | No       |
| Warm White | C513A-MSN-CW0Y0232 | 55            | 3000                     | 8200 | M2,M3          | Ammo    | No       |
| Warm White | C513A-MSN-CV0Y0512 | 55            | 2130                     | 8200 | W5,M1          | Ammo    | No       |
| Warm White | C513A-MSN-CW0Y0512 | 55            | 3000                     | 8200 | W5,M1          | Ammo    | No       |

### Notes:

1. The above kit numbers represent order codes that include multiple intensity-bin and color-bin codes. Only one intensity-bin code and one color-bin code will be shipped on each bulk. Single intensity-bin code and single color-bin codes will not be orderable.
2. Please refer to the "Cree LED Lamp Reliability Test Standards" document for reliability test conditions.
3. Please refer to the "Cree LED Lamp Soldering & Handling" document for information about how to use this LED product safely.

## GRAPHS

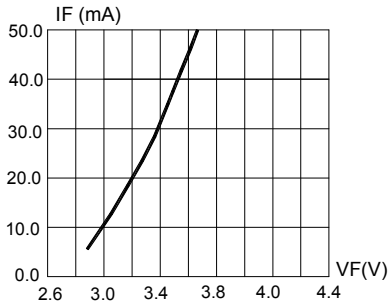

FIG.1 FORWARD CURRENT VS. FORWARD VOLTAGE.

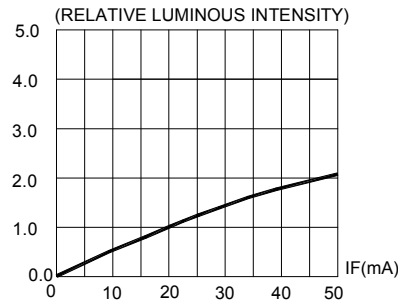

FIG.2 RELATIVE LUMINOUS INTENSITY VS. FORWARD CURRENT

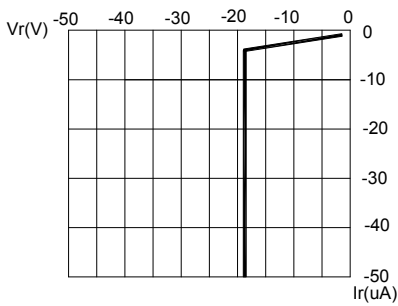

FIG.3 REVERSE CURRENT VS. REVERSE VOLTAGE.

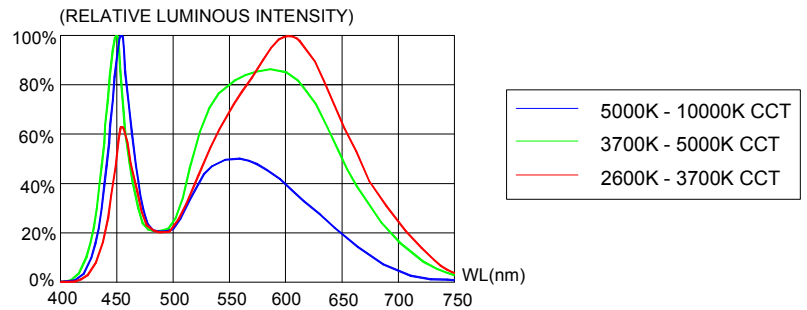

FIG.4 RELATIVE LUMINOUS INTENSITY VS. WAVELENGTH.

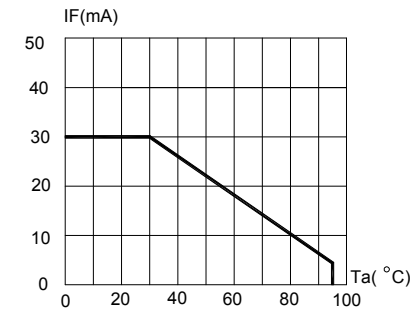

FIG.5 MAXIMUM FORWARD DC CURRENT VS AMBIENT TEMPERATURE ( $T_{jmax}=105^{\circ}C$ )

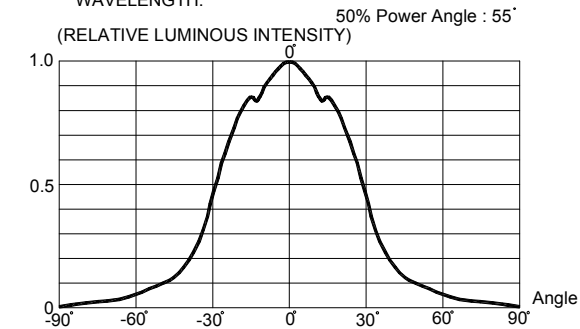

FIG.6 FAR FIELD PATTERN

The above data are collected from statistical figures that do not necessarily correspond to the actual parameters of each single LED. Hence, these data will be changed without further notice.

## MECHANICAL DIMENSIONS

All dimensions are in mm. Tolerance is  $\pm 0.25$  mm unless otherwise noted.

An epoxy meniscus may extend about 1.5 mm down the leads.

Burr around bottom of epoxy may be 0.5 mm max.

C513A-WSS/MSS:

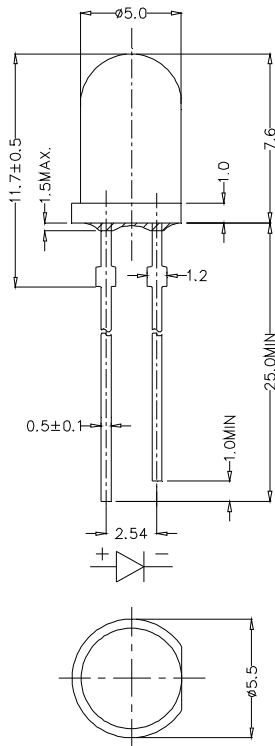

C513A-WSN/MSN:

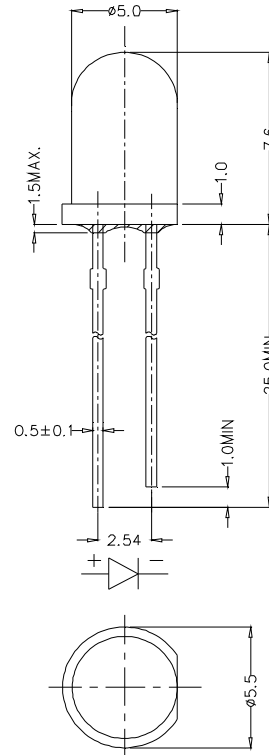

## NOTES

### RoHS Compliance

The levels of environmentally sensitive, persistent biologically toxic (PBT), persistent organic pollutants (POP), or otherwise restricted materials in this product are below the maximum concentration values (also referred to as the threshold limits) permitted for such substances, or are used in an exempted application, in accordance with EU Directive 2002/95/EC on the restriction of the use of certain hazardous substances in electrical and electronic equipment (RoHS), as amended through April 21, 2006.

### Vision Advisory Claim

Users should be cautioned not to stare at the light of this LED product. The bright light can damage the eye.

### KIT NUMBER SYSTEM

All dimensions in mm. Cree LED lamps are tested and sorted into performance bins. A bin is specified by ranges of color, forward voltage, and brightness. Sorted LEDs are packaged for shipping in various convenient options. Please refer to the "Cree LED Lamp Packaging Standard" document for more information about shipping and packaging options.

Cree LEDs are sold by order codes in combinations of bins called kits. Order codes are configured in the following manner:

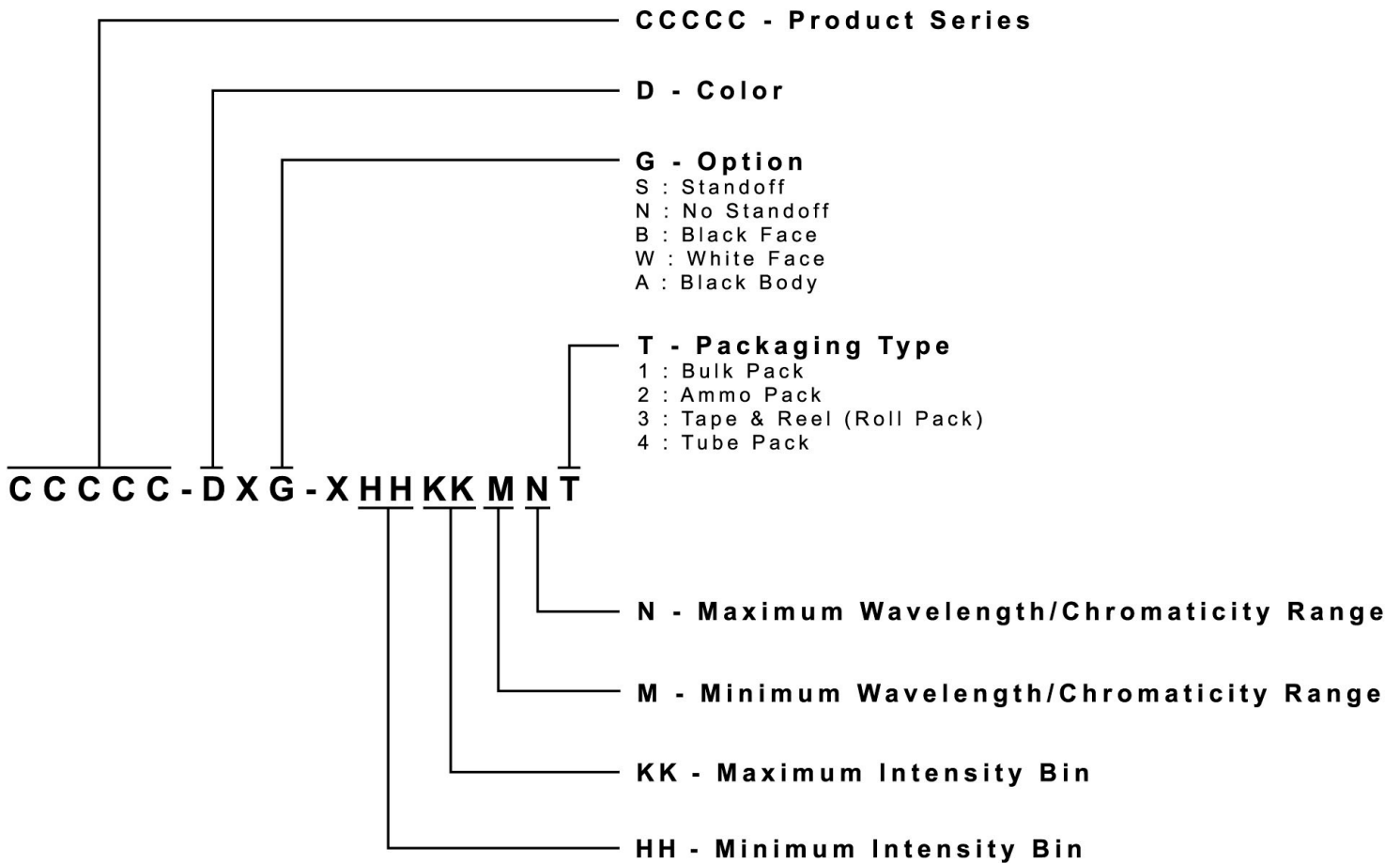

## PACKAGING

### Features:

- The LEDs are packed in cardboard boxes after packaging in normal or anti-electrostatic bags.
- Cardboard boxes will be used to protect the LEDs from mechanical shock during transportation.
- The boxes are not water resistant, and they must be kept away from water and moisture.
- The Bulk Pack types of packaging.
- Max 500 pcs per bulk and Max 2500 pcs per ammo.

### Bulk Pack Packaging Type:

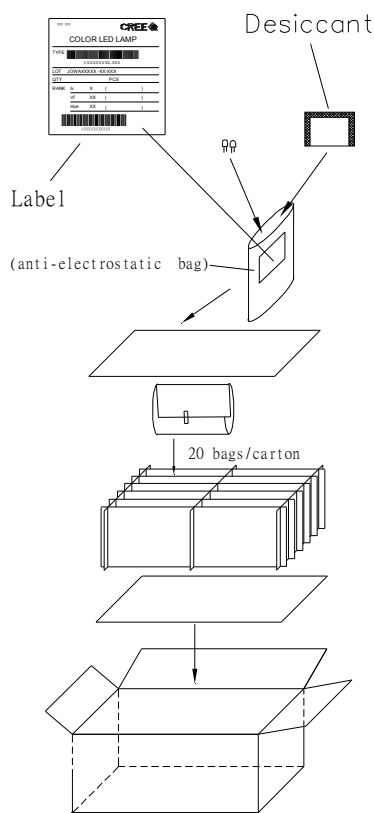

### Ammo Pack Packaging Type:

