

# Printed-circuit board connector - DMCV 1,5/ 6-G1F-3,5-LRP20THRR5 - 1818740

Please be informed that the data shown in this PDF Document is generated from our Online Catalog. Please find the complete data in the user's documentation. Our General Terms of Use for Downloads are valid (<http://phoenixcontact.com/download>)



Header, Nominal current: 8 A, Rated voltage (III/2): 160 V, Number of positions: 6, Pitch: 3.5 mm, Color: black, Contact surface: Tin, Mounting: Taped SMD/THT/THR components

The figure shows a 10-pos. version with 20 contacts



## Key commercial data

Packing unit	220 pc
Minimum order quantity	220 pc
GTIN	 4 046356 757850
Weight per Piece (excluding packing)	3.53 g
Custom tariff number	85366990
Country of origin	Germany
Note	Made to Order (non-returnable)

## Technical data

### Dimensions

Length	10.6 mm
Height	12 mm
Pitch	3.5 mm
Dimension a	17.5 mm
Pin dimensions	0,8 x 0,8 mm
Pin spacing	5.50 mm
Hole diameter	1.4 mm

### General

Range of articles	DMCV 1,5/...-G1F-THR
Insulating material group	IIIa
Rated surge voltage (III/3)	2.5 kV
Rated surge voltage (III/2)	2.5 kV

# Printed-circuit board connector - DMCV 1,5/ 6-G1F-3,5-LRP20THRR5 - 1818740

## Technical data

### General

Rated surge voltage (II/2)	2.5 kV
Rated voltage (III/3)	160 V
Rated voltage (III/2)	160 V
Rated voltage (II/2)	250 V
Connection in acc. with standard	EN-VDE
Nominal current I <sub>N</sub>	8 A
Maximum load current	8 A
Insulating material	LCP
Inflammability class according to UL 94	V0
Color	black
Number of positions	6

## Classifications

### eCl@ss

eCl@ss 4.0	272607xx
eCl@ss 4.1	27260701
eCl@ss 5.0	27260701
eCl@ss 5.1	27260701
eCl@ss 6.0	27260704
eCl@ss 7.0	27440402
eCl@ss 8.0	27440402

### ETIM

ETIM 3.0	EC001121
ETIM 4.0	EC002637
ETIM 5.0	EC002637

### UNSPSC

UNSPSC 6.01	30211810
UNSPSC 7.0901	39121409
UNSPSC 11	39121409
UNSPSC 12.01	39121409
UNSPSC 13.2	39121409

## Approvals

### Approvals

# Printed-circuit board connector - DMCV 1,5/ 6-G1F-3,5-LRP20THRR5 - 1818740

## Approvals

### Approvals

UL Recognized / cUL Recognized / VDE Gutachten mit Fertigungsüberwachung / IEC60947-5 CB Scheme / cULus Recognized

### Ex Approvals

### Approvals submitted

## Approval details

UL Recognized		
	B	C
Nominal current I <sub>N</sub>	8 A	8 A
Nominal voltage U <sub>N</sub>	150 V	50 V

cUL Recognized		
	B	C
Nominal current I <sub>N</sub>	8 A	8 A
Nominal voltage U <sub>N</sub>	150 V	50 V

VDE Gutachten mit Fertigungsüberwachung	
Nominal current I <sub>N</sub>	8 A
Nominal voltage U <sub>N</sub>	160 V

IECEE CB Scheme	
Nominal current I <sub>N</sub>	8 A
Nominal voltage U <sub>N</sub>	160 V

# Printed-circuit board connector - DMCV 1,5/ 6-G1F-3,5-LRP20THRR5 - 1818740

## Approvals

cULus Recognized 

## Accessories

Accessories

Coding element

Coding profile - CP-DMC 1,5 NAT - 1790647

Coding profile, for plugging into the coding ribs of the plug or header at a later date, insulating material, color: natural



## Additional products

Printed-circuit board connector - DFMC 1,5/ 6-STF-3,5 - 1790331

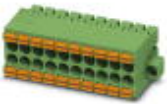

Plug, nominal current: 8 A, rated voltage (III/2): 160 V, number of positions: 6 with 12 contacts, pitch: 3.5 mm, connection method: spring-cage connection, color: green, contact surface: tin

Printed-circuit board connector - DFMC 1,5/ 6-ST-3,5-LR - 1790522



Plug, nominal current: 8 A, rated voltage (III/2): 160 V, number of positions: 6 with 12 contacts, pitch: 3.5 mm, connection method: spring-cage connection, color: green, contact surface: tin

## Drawings

# Printed-circuit board connector - DMCV 1,5/ 6-G1F-3,5-LRP20THRR5 - 1818740

Schematic diagram

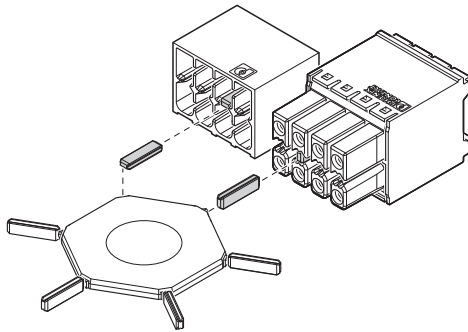

Drilling diagram

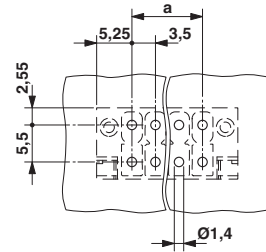

Use of the CP-DMC... coding profile

Diagram

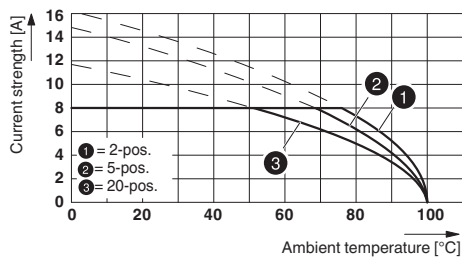

Dimensioned drawing

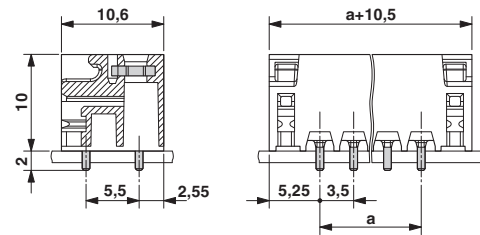

Schematic diagram

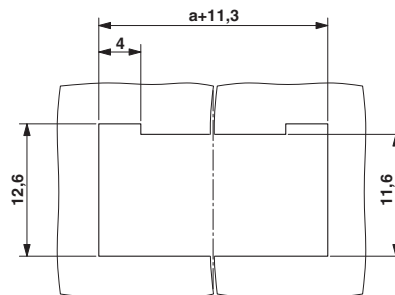

Panel cutout