

**KEMET Part Number: LDEIC2180KA0N00**  
(DEIC2180KA0N00)

Capacitor, film, 0.018 uF, +/-10% Tol, General Purpose, 250 VDC@125C

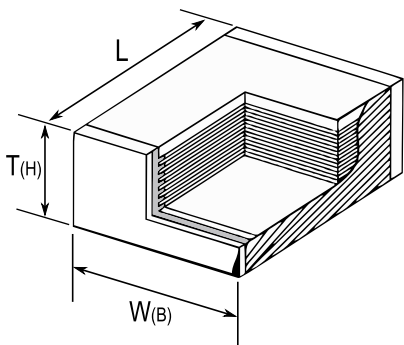

Note: '()' correspond to the letters used in the product bulletin

Dimensions (mm)		
Symbol	Dimension	Tolerance
L	4.7	+0.3/-0.2
W	3.3	+/-0.3
T	1.8	MAX

Packaging Specifications	
Package Kind:	T&R
Package Size:	Standard
Package Quantity:	4000

General Information	
Supplier:	KEMET
Dielectric:	Metallized PEN (Stacked)
Application:	General Purpose
Sub Application:	AEC-Q200
Style:	Surface Mount
Chip Size:	1812 (4532 metric)
RoHS:	Yes

Specifications	
Capacitance:	0.018 uF
Voltage:	250 VDC
Tolerance:	+/-10%
Voltage AC:	120 VAC
Rated Temperature:	125C
Temperature Range:	-55/+125C
Dissipation Factor @ 1 kHz:	0.8%
Insulation Resistance:	1 GOhm
Maximum dVdT:	100 v/us