

DETAILS

Product Number	C14275_SHELLY-T-6X1-N
Family	Shelly
Type	Lens
Color	clear
Diameter	119.8 + 19.6 mm
Height	7 mm
Style	rectang
Optic Material	PMMA
Holder Material	
Fastening	screw, pin
Status	ready
ROHS Compliant	Yes
Date Updated	20/03/2015



OPTICAL PROPERTIES

LED	Viewing Angle	Light Beam	Efficiency	cd/lm	Connector
XP-E	sim: Asymmetric	Asymmetric	sim: 92 %	sim: 0.000	-
NCSxx19A	Asym deg	Asymmetric	94 %	0.460	-
NF2x757A	Asymmetric deg	Asymmetric	94 %	0.460	-
XQ-E	Asym deg	Asymmetric	93 %	0.510	-
LUXEON TX	Asymmetric deg	Asymmetric	94 %	0.450	-
Duris S5 (2 chip)	Asym deg	Asymmetric	93 %	0.480	-
NCSxx19B	Asymmetric deg	Asymmetric	94 %	0.410	-
NVSxx19A	Asymmetric deg	Asymmetric	94 %	0.440	-
NVSxx19B/NVSxx19C	Asymmetric deg	Asymmetric	94 %	0.420	-
LUXEON Z ES	Asym deg	Asymmetric	93 %	0.500	-
LUXEON T	Asymmetric deg	Asymmetric	94 %	0.440	-
LUXEON Rebel ES	Asymmetric deg	Asymmetric	94 %	0.450	-
XB-D	Asymmetric deg	Asymmetric	94 %	0.430	-
XQ-D	sim: Asymmetric	Asymmetric	sim: 88 %	sim: 0.000	-
LUXEON Rebel	Asymmetric deg	Asymmetric	94 %	0.490	-

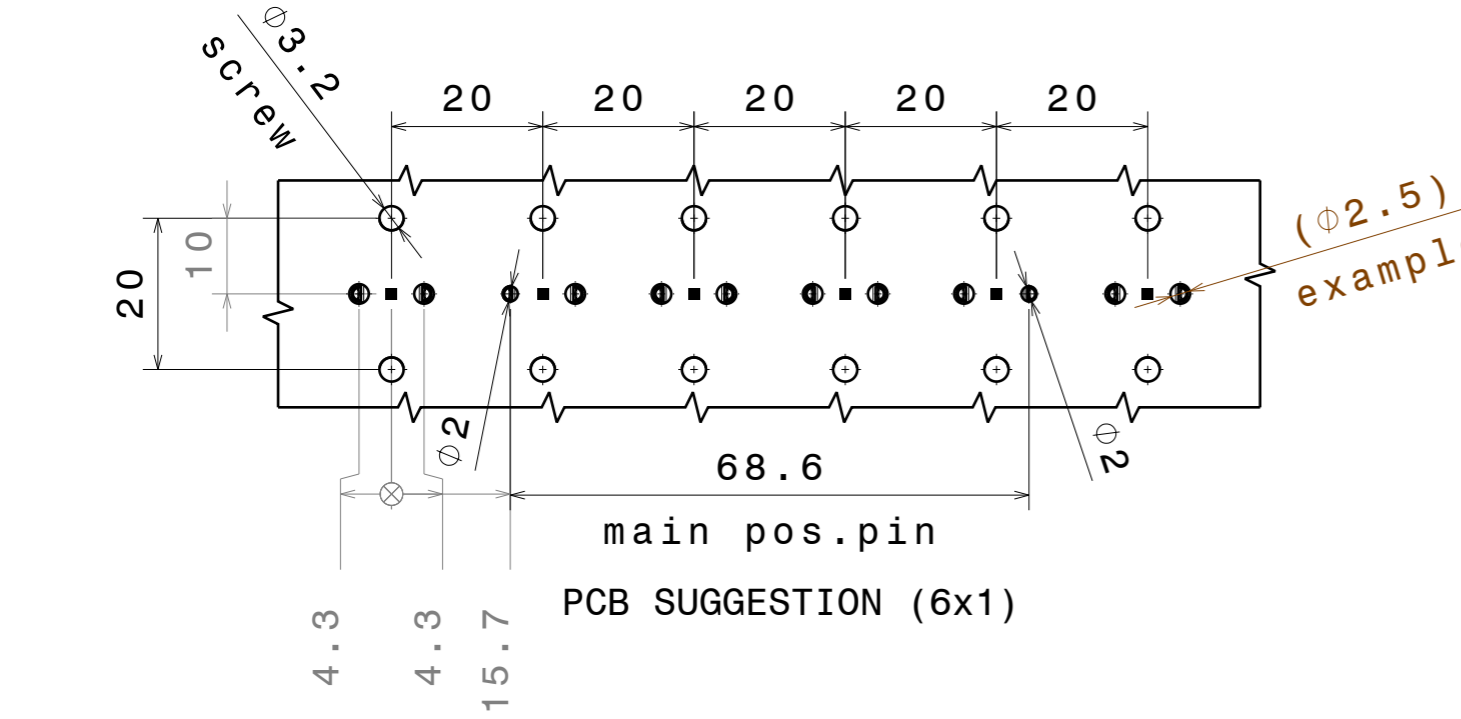
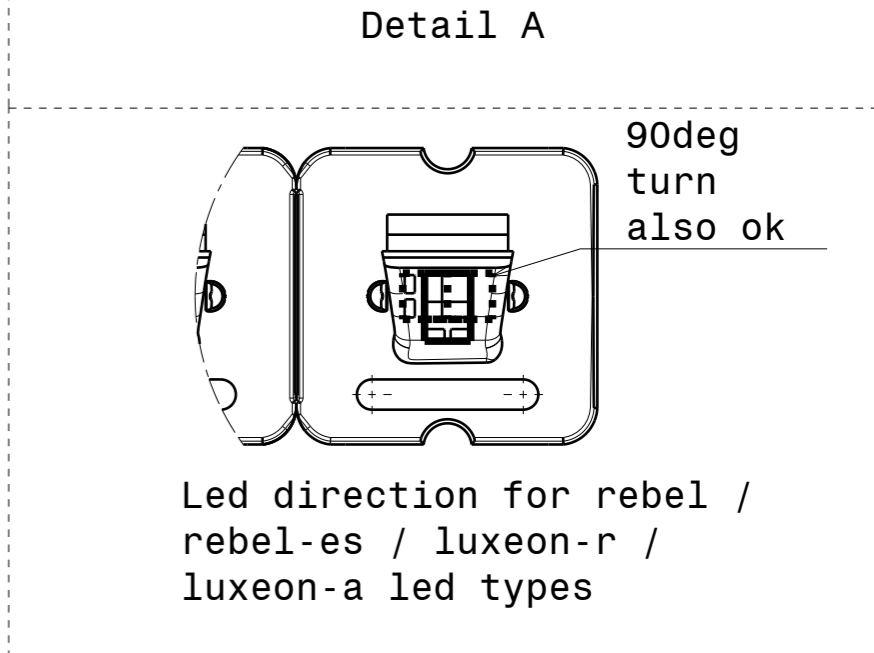
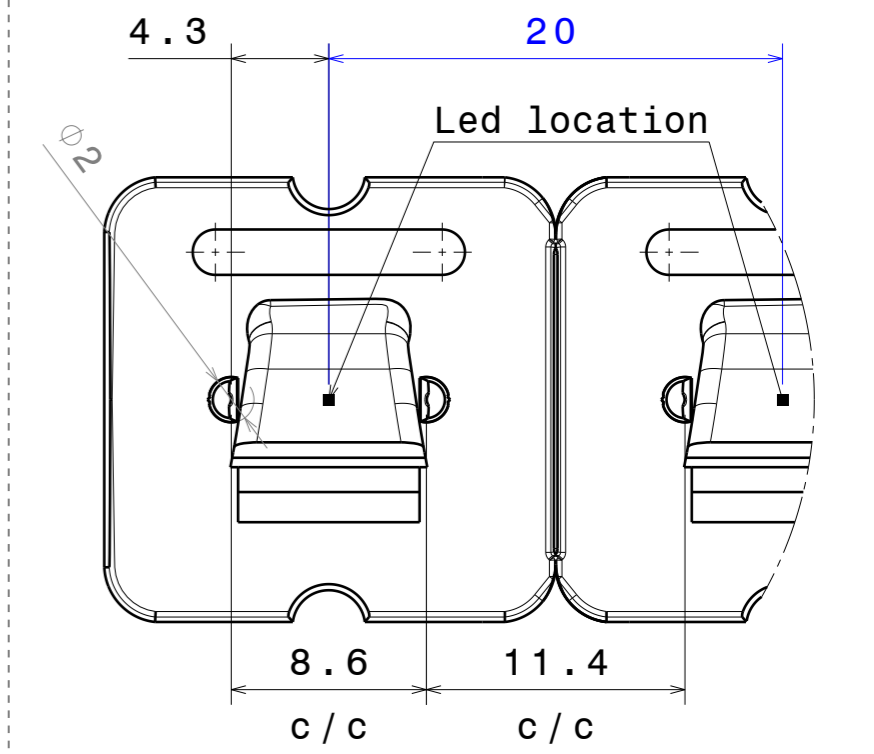
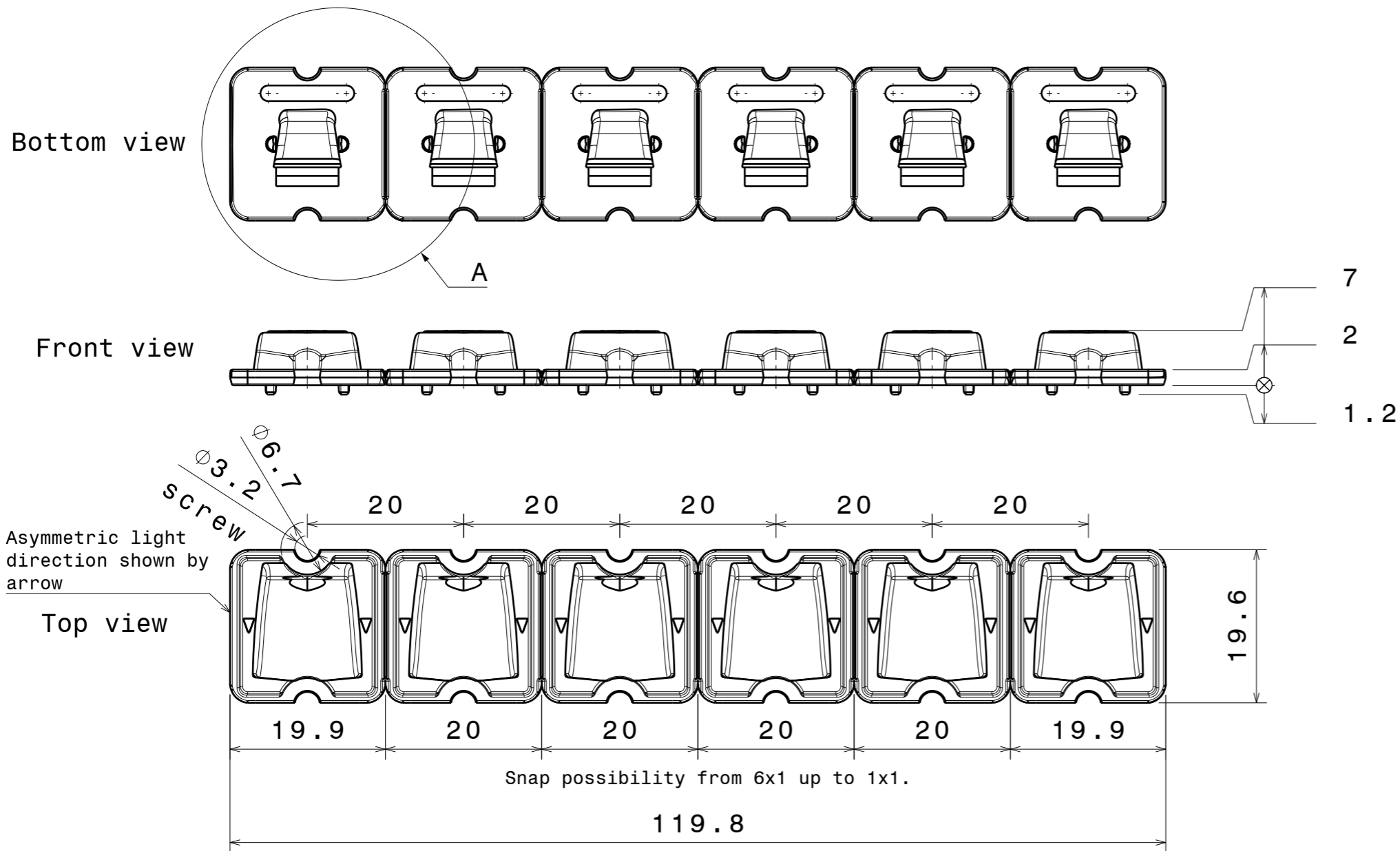

To ease assembly: two main 2mm position pins holes recommended to use - other holes larger sized or oval/oblong geometry.

(φ2.5) example

Tolerances if not otherwise shown
According to DIN ISO 2768-1
Linear measures:
Up to 30mm class M, otherwise class C.
According to DIN ISO 2768-2
Form and position: class L

THIRD ANGLE PROJECTION:

This drawing is the property of LEDiL Oy. It may not be reproduced, copied or communicated without a written agreement with LEDiL Oy.

INDEX	PART NO	DESCRIPTION	MATERIAL	COLOUR
1	C14275	SHELLY-T-6X1-N	PMMA	
		Ledil Oy Salorankatu 10 FIN 24240 SALO Finland		
		DRAWING TITLE		
SIZE		PART NUMBER		
A3		C14275		
SCALE	1:1	WEIGHT	- g	SHEET 1/1

Luminaire: LEDiL Oy C14275_SHELLY-T-6X1-N_(NCS19A) Eff.94.7%
Lamps: 1 x NICHIA_NCS19A_1x6_531.294lm@250mA_P=4.61215W_I=249.9mA

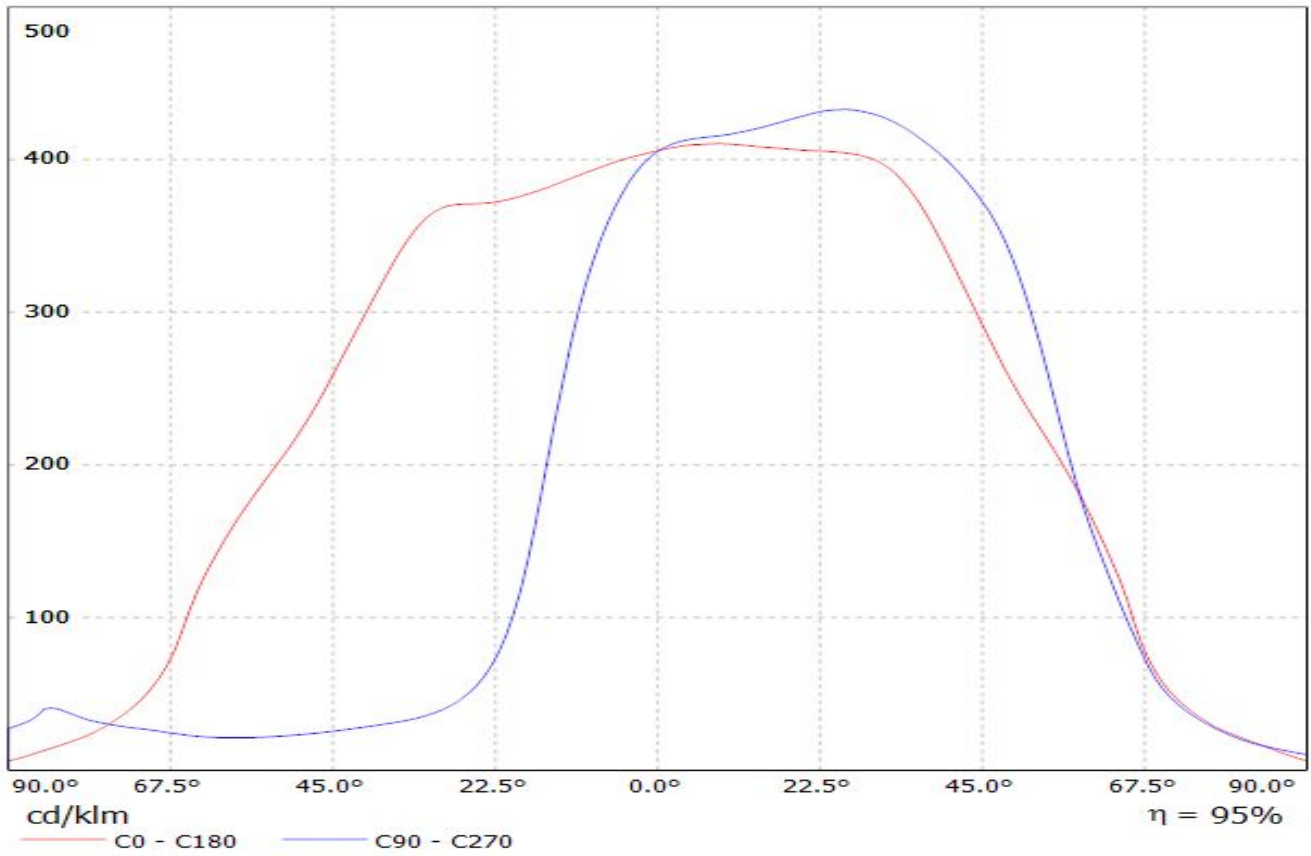

Luminaire: LEDiL Oy C14275_SHELLY-T-6X1-N_(NF2x757A)
Lamps: 1 x Nichia_NF2x757A_6x1_405.289lm@100mA_P=3.58939W_I=100.1mA

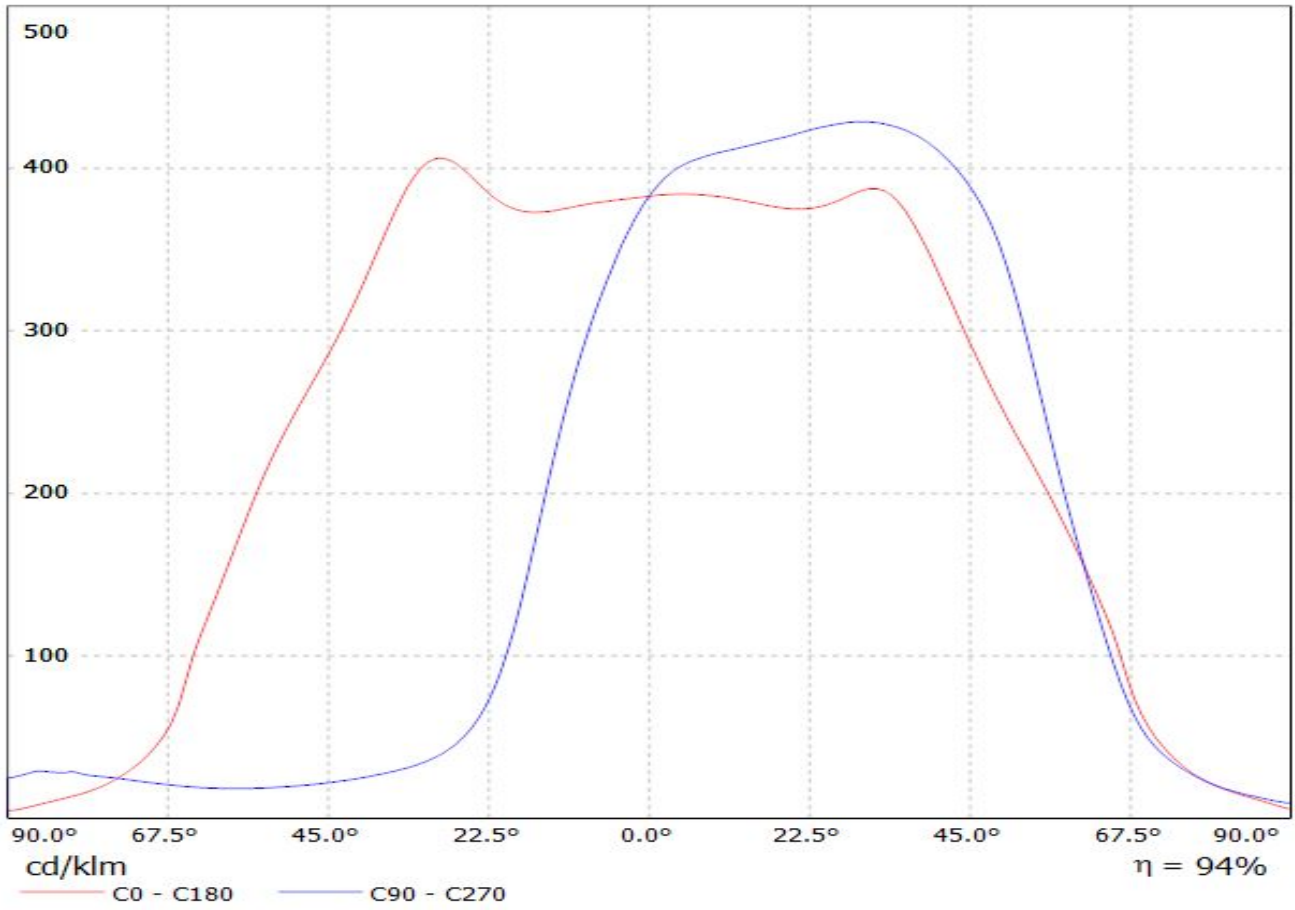

Luminaire: Ledil C14275_SHELLY-T-6X1-N_(XQ-E)

Lamps: 1 x Cree_XQ-E_(XQEAWT-0-7B1-Q40-0H-00001)_497.31lm@250mA_P=4.5957W_I=0.250A

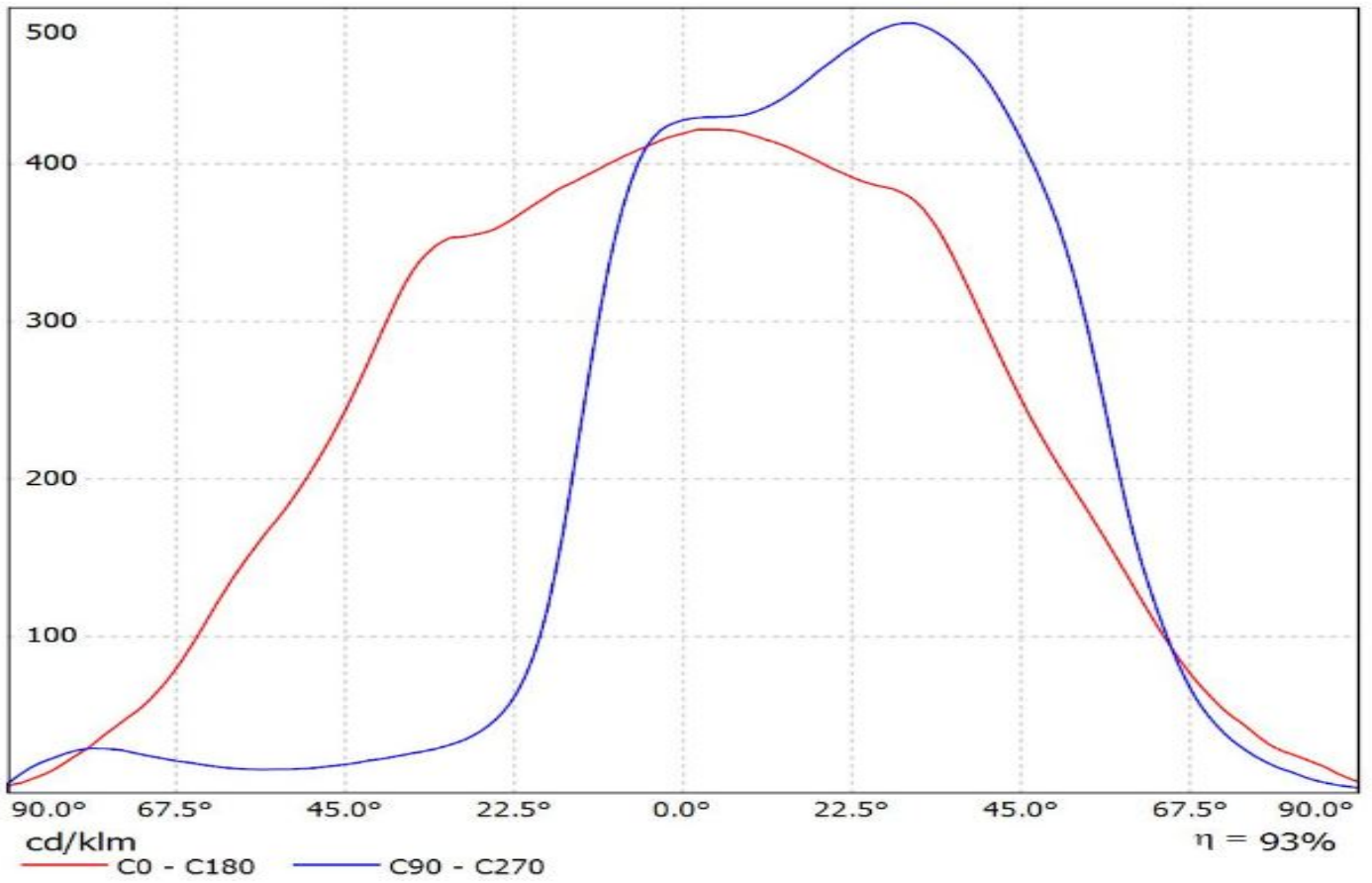

Luminaire: LEDiL Oy C14275_SHELLY-T-6X1-N_(Luxeon_TX)

Lamps: 1 x Luxeon_TX_6x1_(L1T2-5770)_652.342lm@250mA_CCT=5700K_P=4.18365W_I=249.8mA

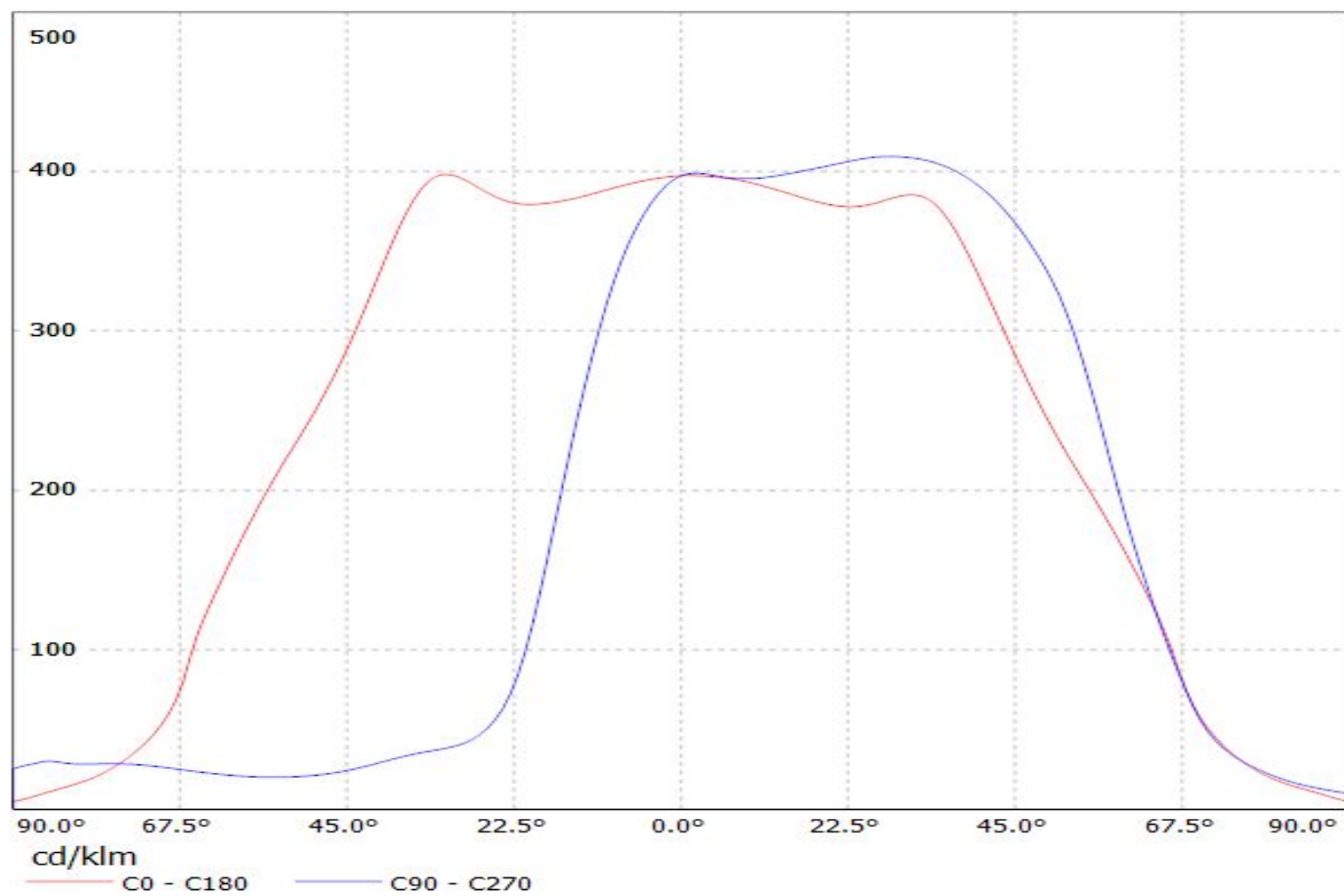

Luminaire: Ledil C14274_SHELLY-T-6X1-WAS (Duris_S5_(2_chip))
Lamps: 1 x Osram_Duris_S5_(2_chip)_(PSLRS1EC-LQLS-5H7I-1)
_756.726lm@150mA_P=5.6W_I=0.150A

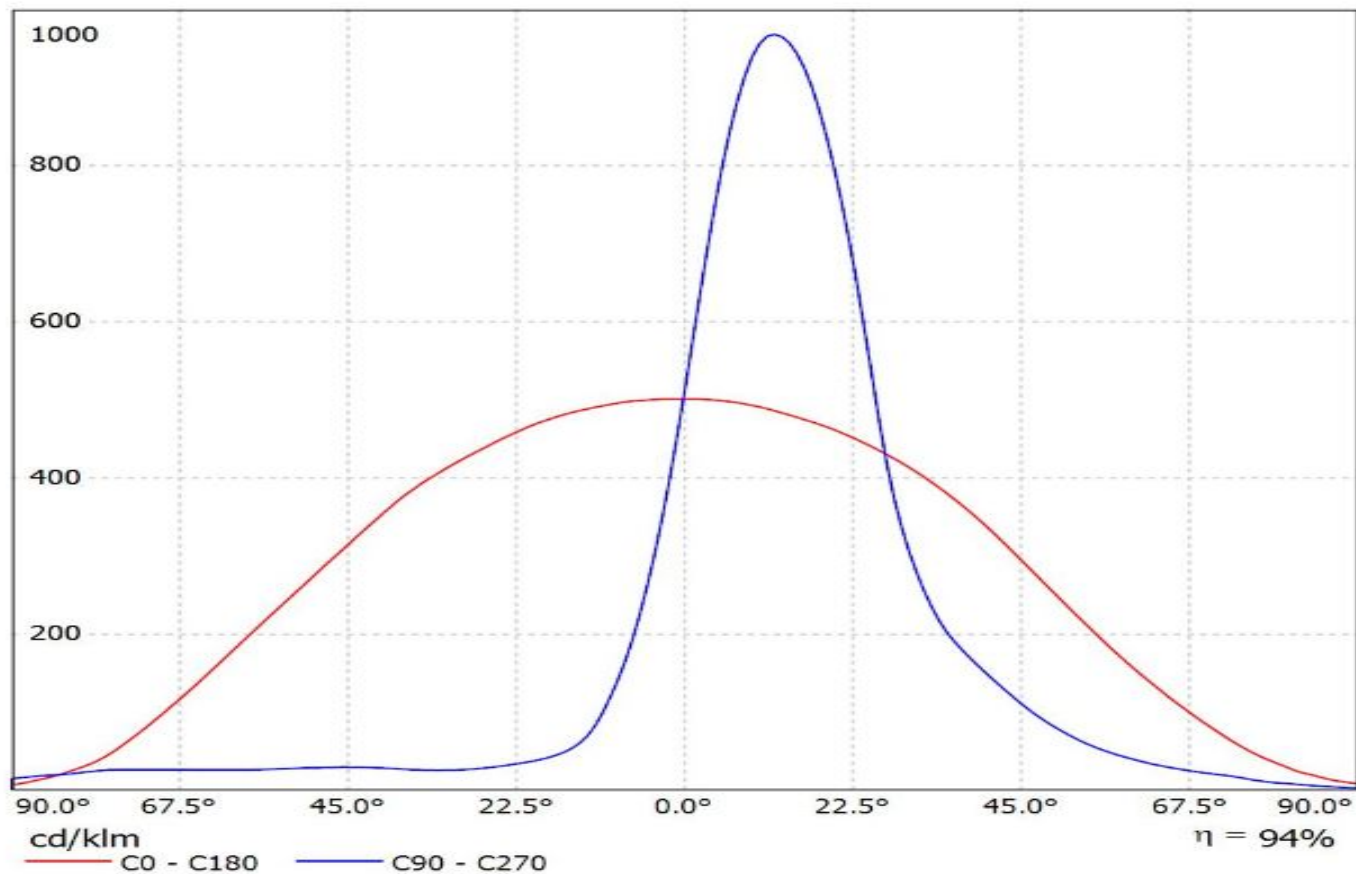

Luminaire: LEDiL Oy C14275_SHELLY-T-6X1-N_(NCSxx19B) Eff.94.3%
Lamps: 1 x NCSxx19B_1x6_623.272lm@250mA_P=4.18008W_I=249.9mA

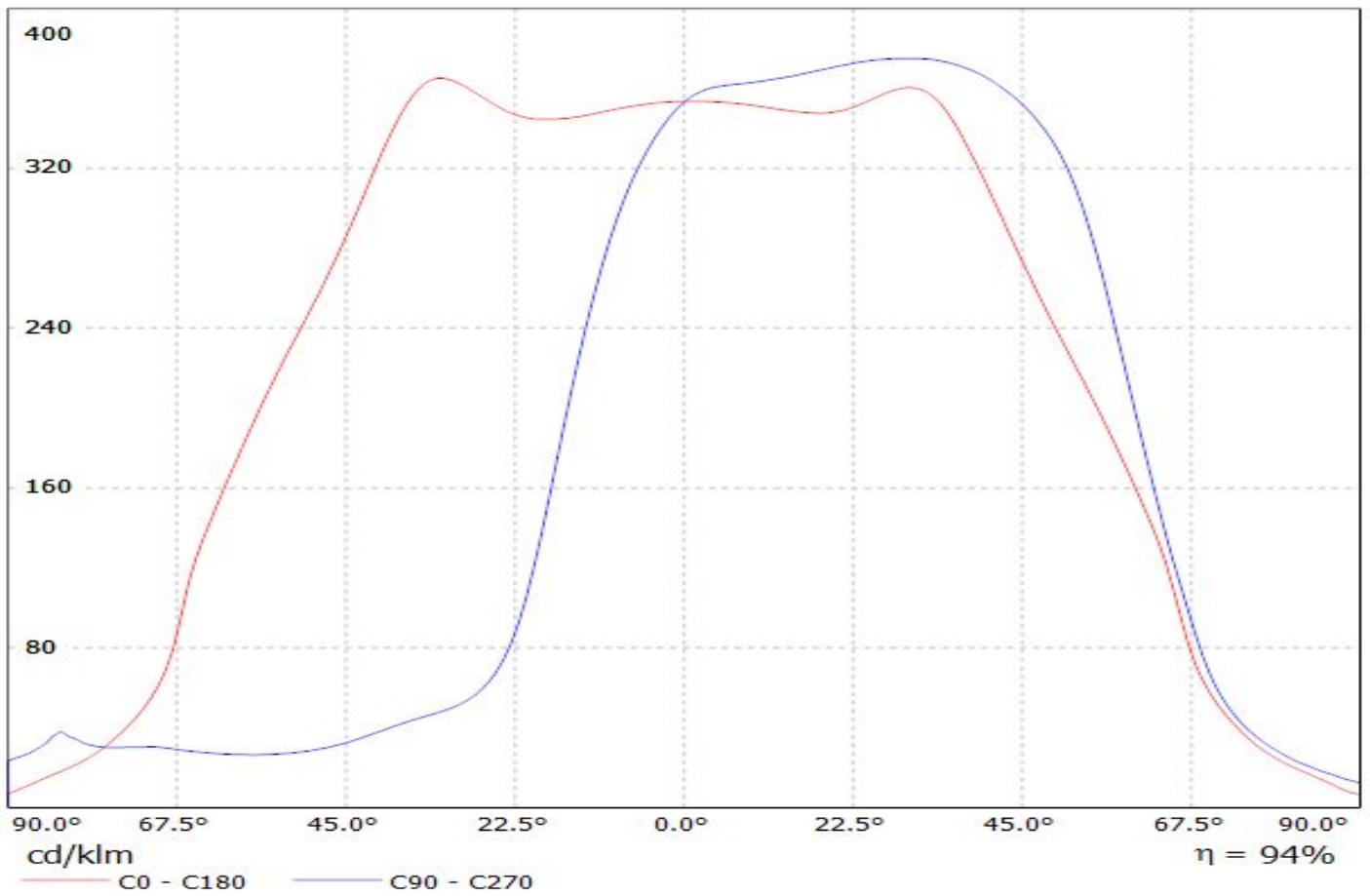

Luminaire: LEDiL Oy C14275_SHELLY-T-6X1-N_(NVSxx19A) Eff.94.5%
Lamps: 1 x NVSxx19A_1x6_578.655lm@250mA_P=4.379W_I=249.9mA

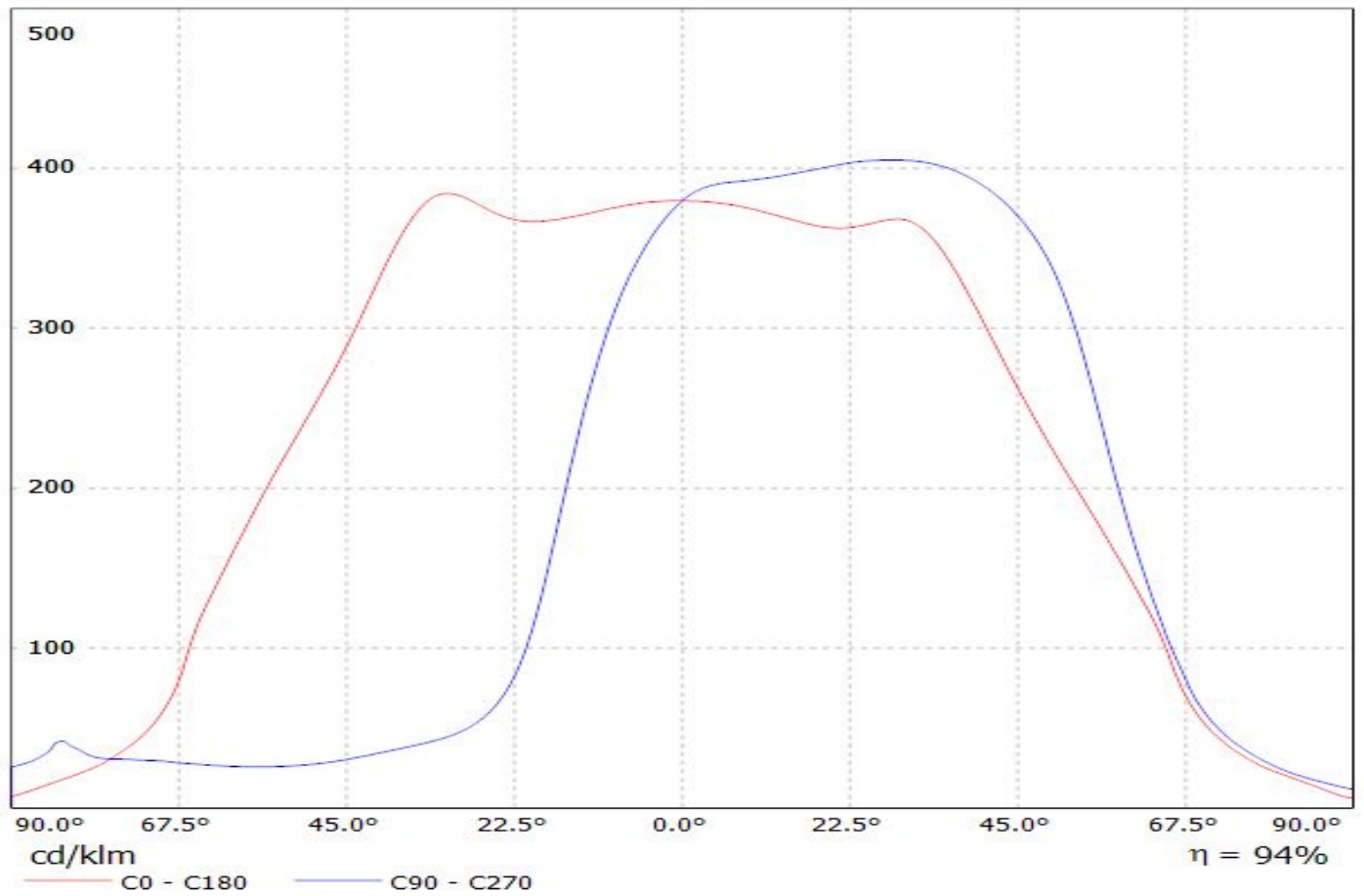

Luminaire: LEDiL Oy C14275_SHELLY-T-6X1-N_(NVSxx19B)
Lamps: 1 x NVSxx19B_1x6_459.756lm@250mA_P=4.21581W_I=249.9mA

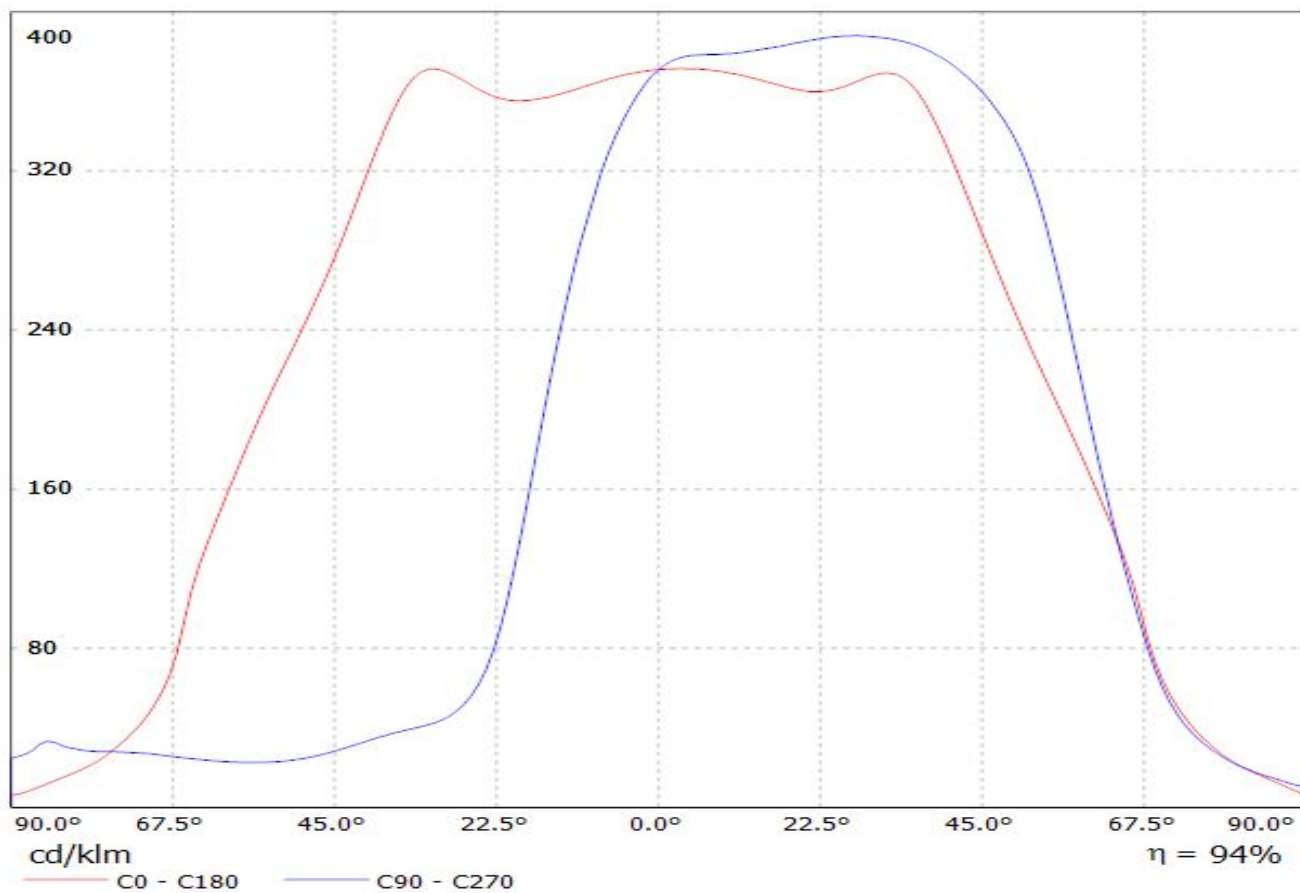

Luminaire: Ledil C14275_SHELLY-T-6X1-N (Luxeon_Z_ES)

Lamps: 1 x Luxeon_Z_ES_(LXZ2-4080-3)_534.9462lm@250mA_P=4.3941W_I=0.250A

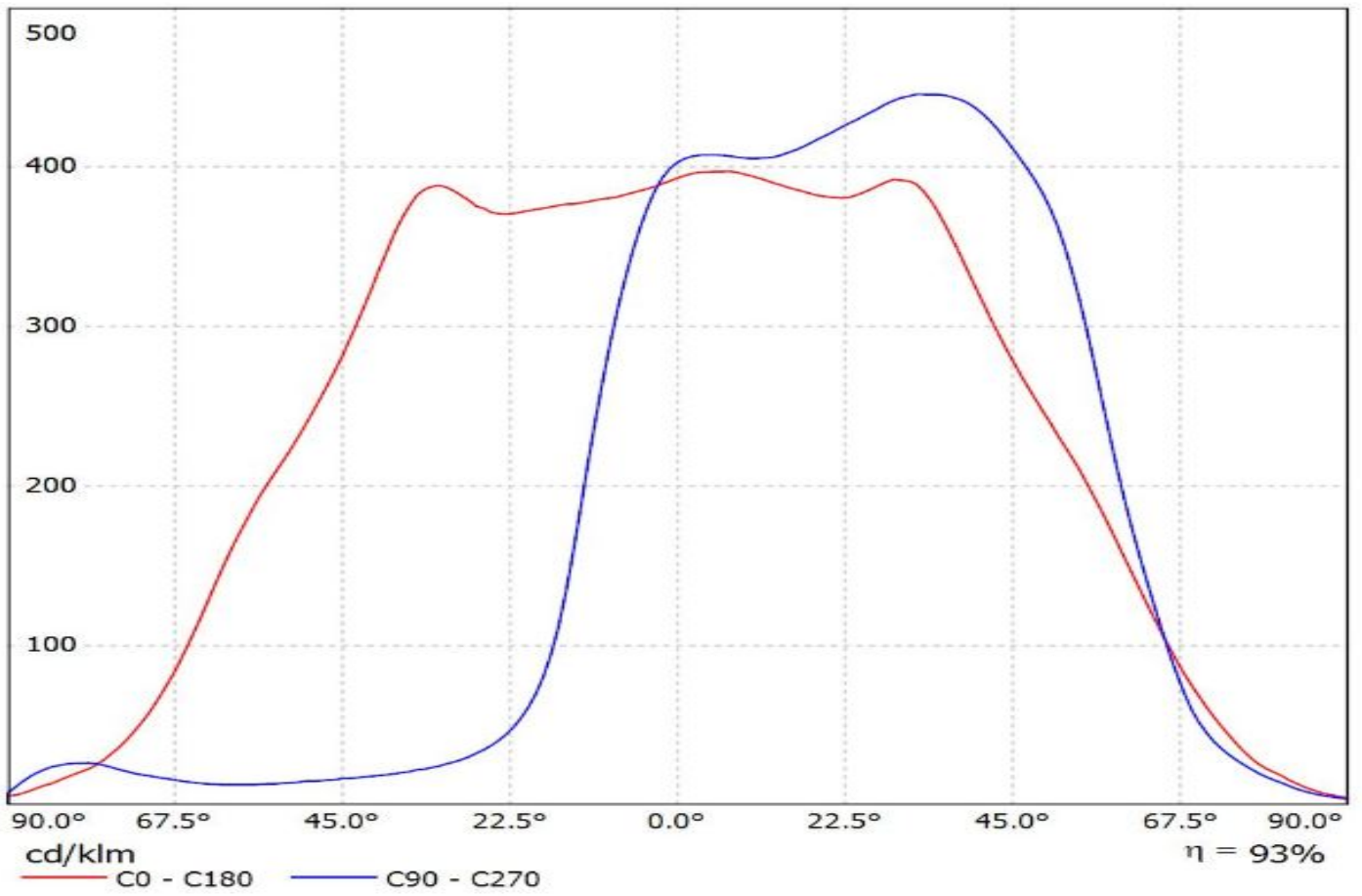

Luminaire: LEDiL Oy C14275_SHELLY-T-6X1-N_(LUXEON_T)

Lamps: 1 x LUXEON_T_1x6_(LXH8-FW30-3)_433.852lm@250mA_P=4.17608W_I=249.9mA

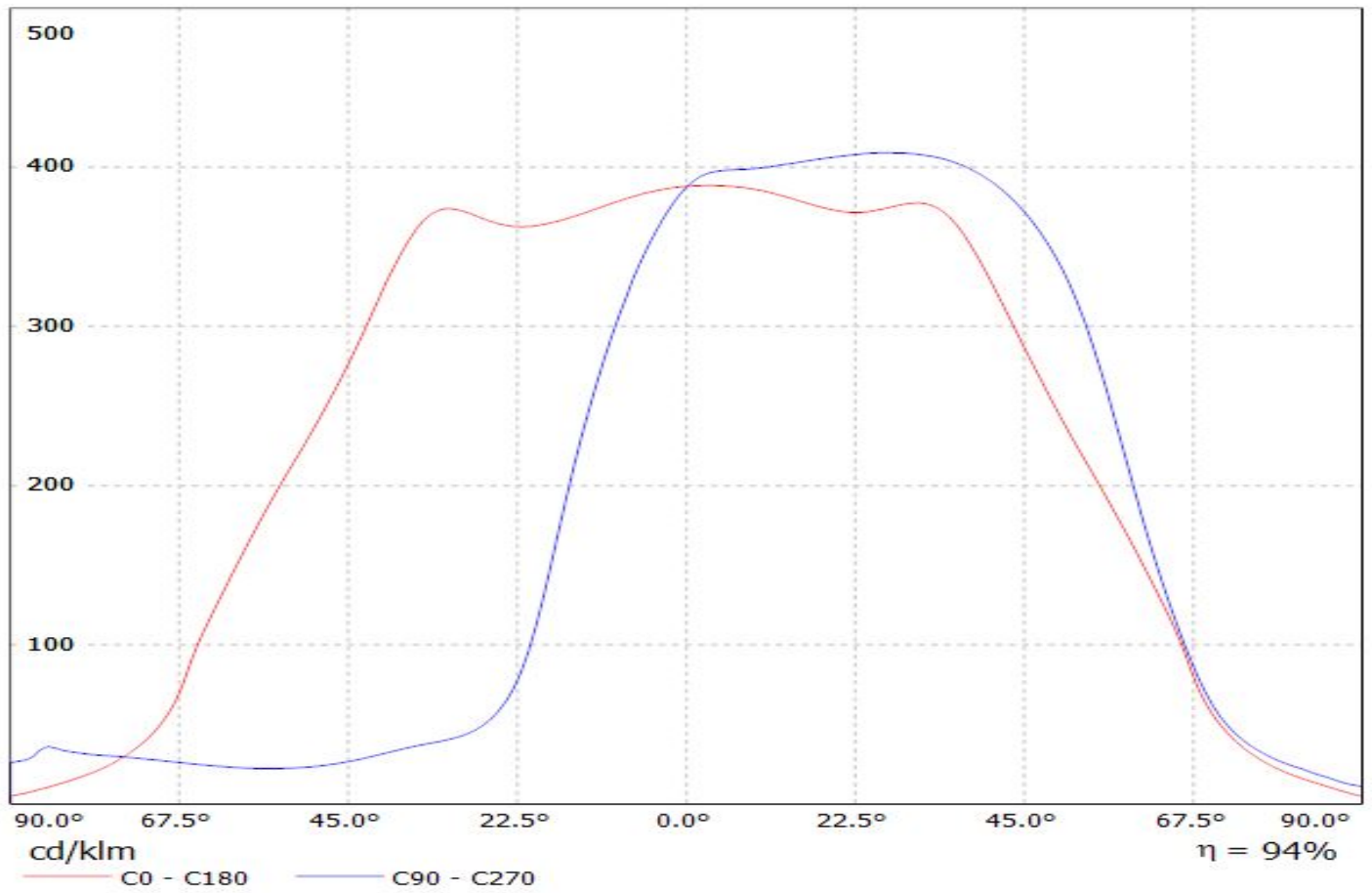

Luminaire: LEDiL Oy C14275_SHELLY-T-6X1-N_(REBEL_ES)

Lamps: 1 x LUXEON_REBEL_ES_1x6_512.943lm@250mA_P=4.33102W_I=249.9mA

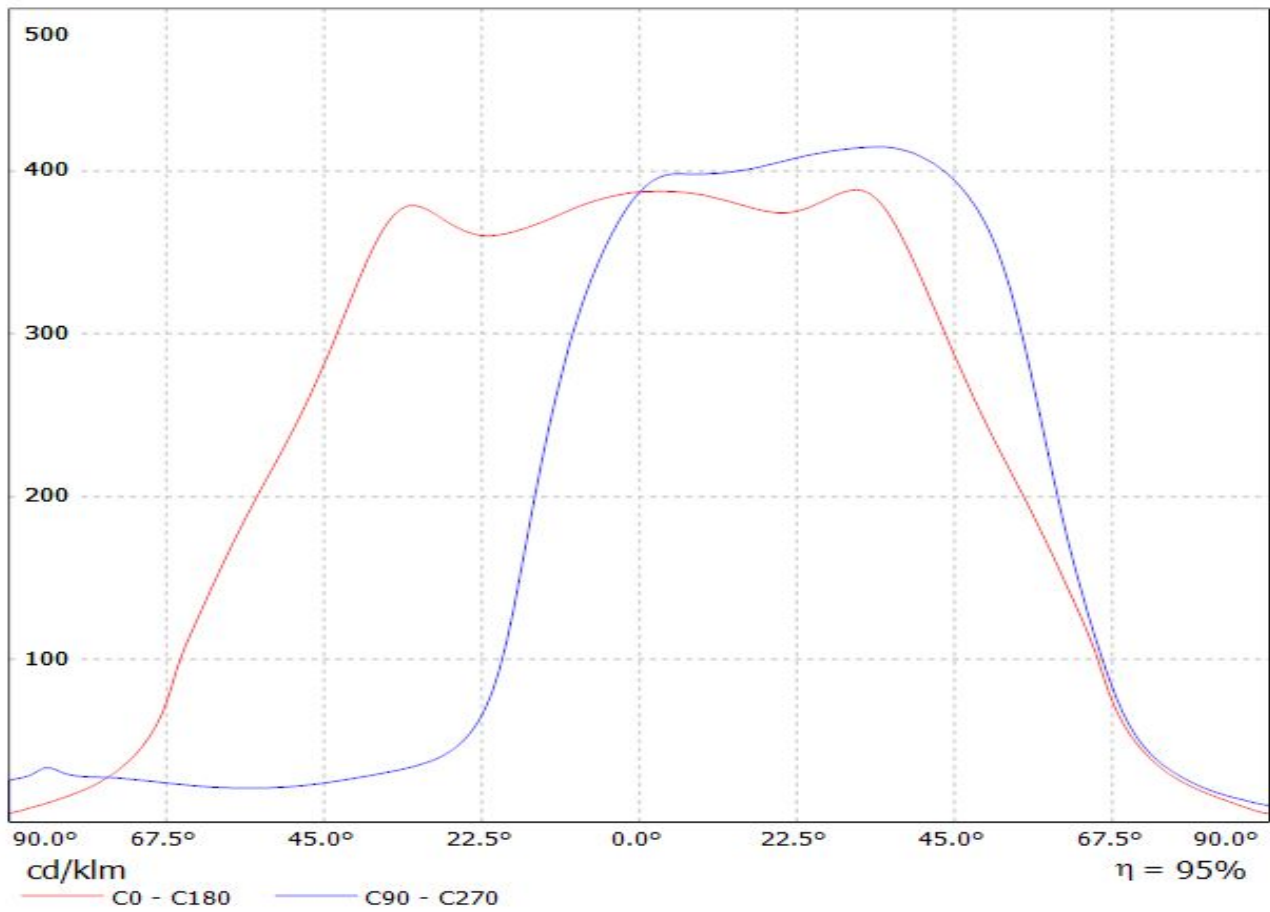

Luminaire: LEDiL Oy C14275_SHELLY-T-6X1-N_(REBEL)
Lamps: 1 x LUXEON_REBEL_1x6_477.529lm@250mA_P=4.23231W_I=249.9mA

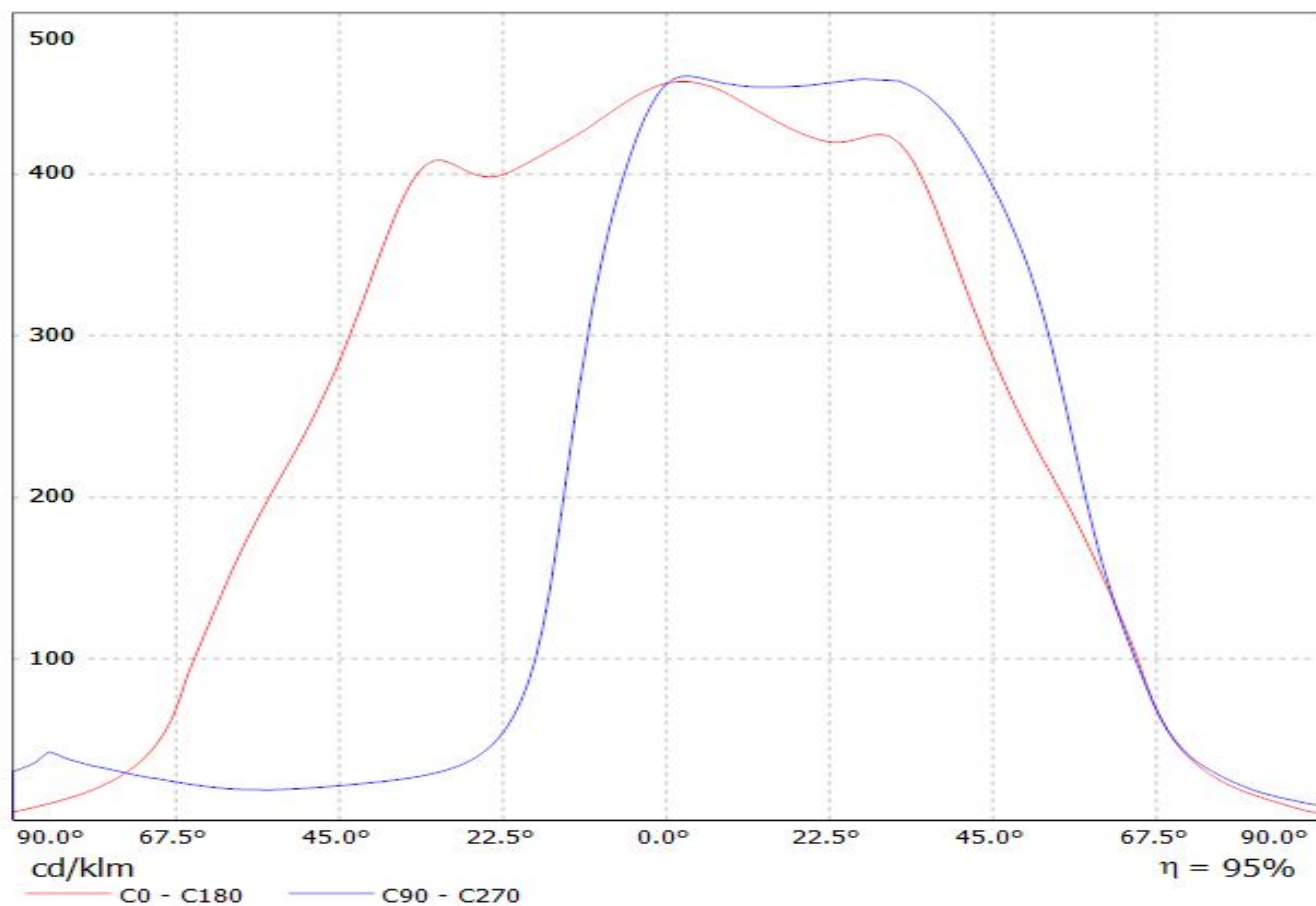

Luminaire: LEDiL Oy C14275_SHELLY-T-6X1-N_(NCS19A) Eff.94.7%
Lamps: 1 x NICHIA_NCS19A_1x6_531.294lm@250mA_P=4.61215W_I=249.9mA

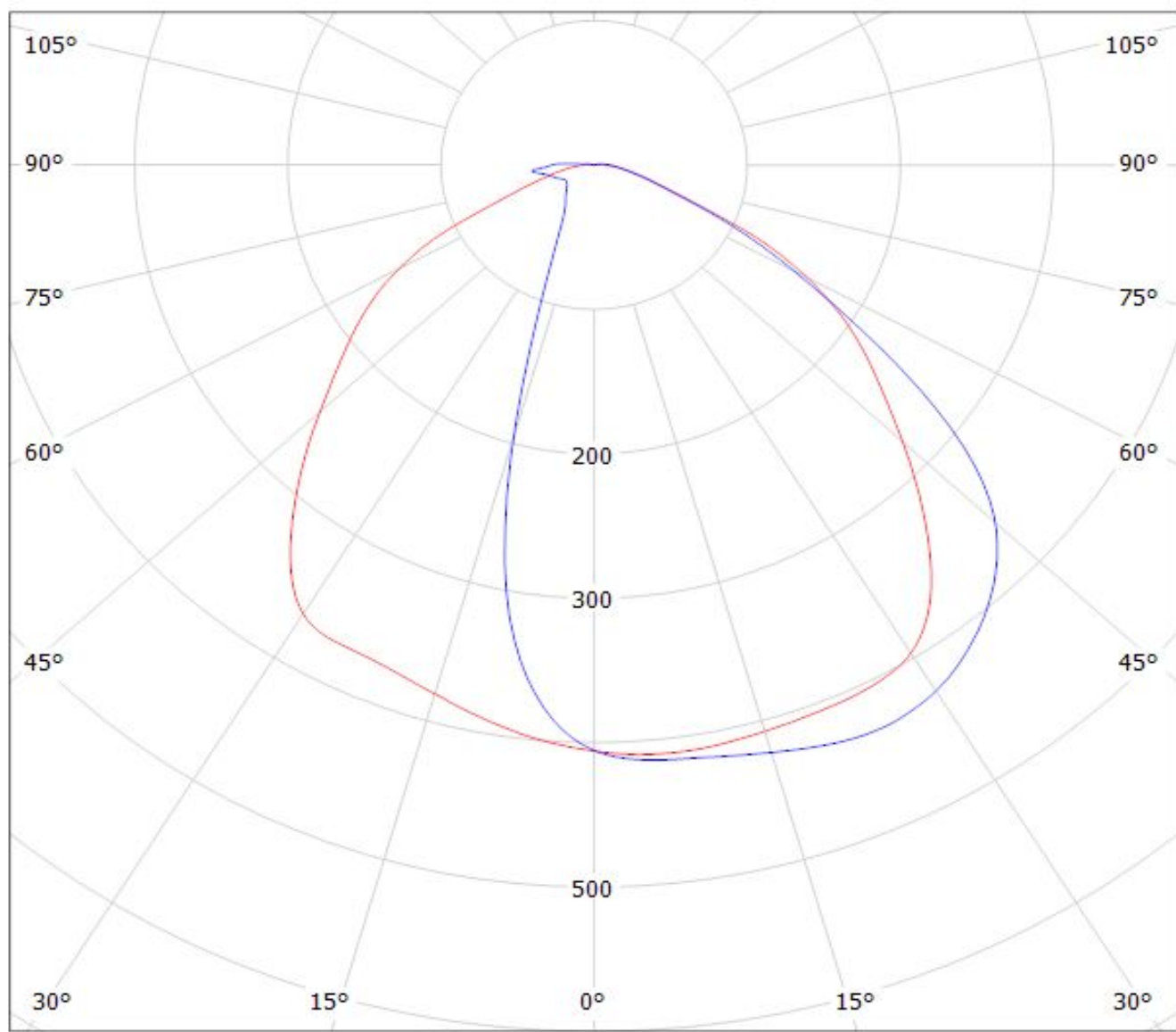

cd/klm
— C0 - C180 — C90 - C270

$\eta = 95\%$

Luminaire: LEDiL Oy C14275_SHELLY-T-6X1-N_(NF2x757A)

Lamps: 1 x Nichia_NF2x757A_6x1_405.289lm@100mA_P=3.58939W_I=100.1mA

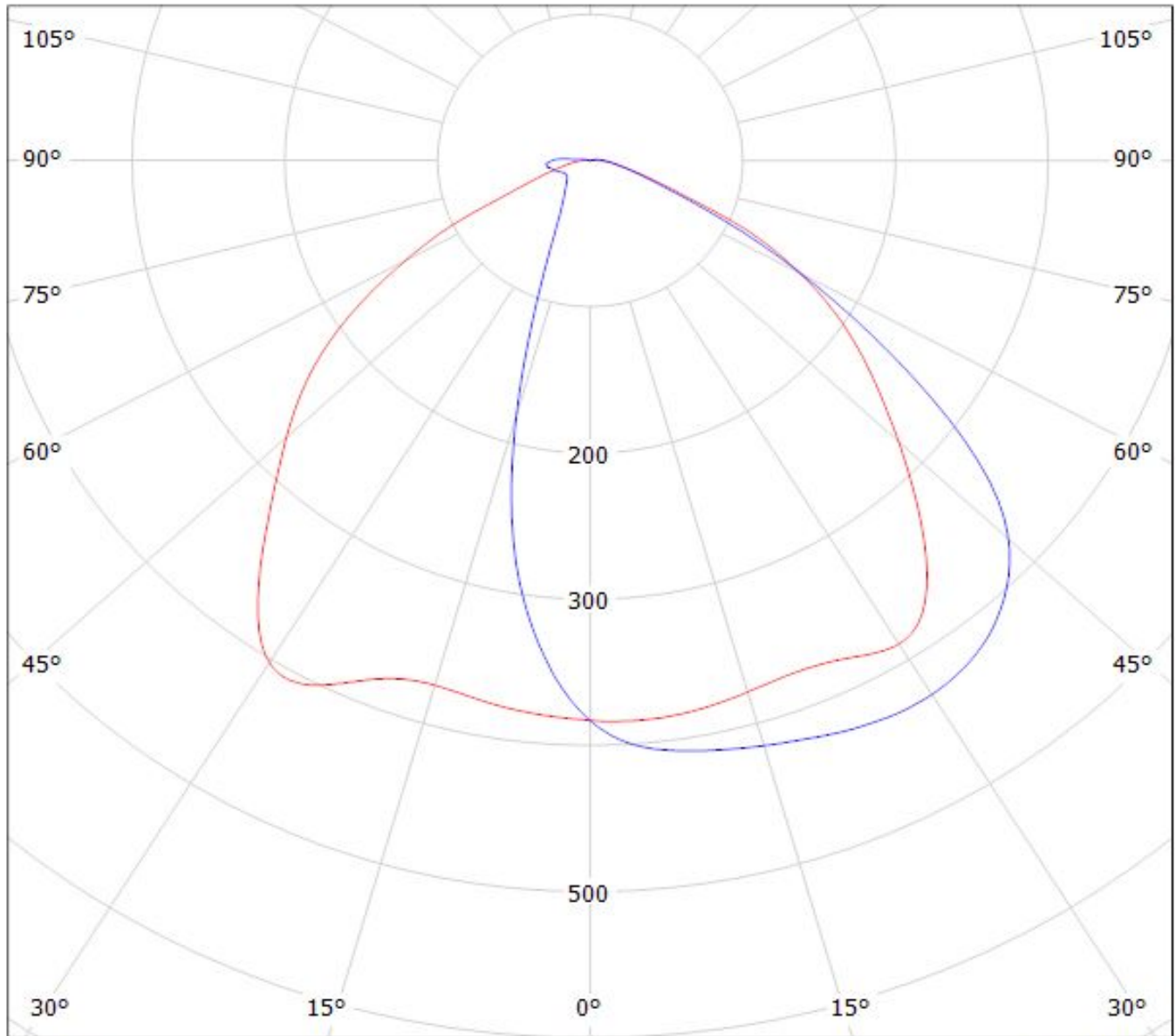

cd/klm

— C0 - C180

— C90 - C270

$\eta = 94\%$

Luminaire: Ledil C14275_SHELLY-T-6X1-N_(XQ-E)

Lamps: 1 x Cree_XQ-E_(XQEAWT-0-7B1-Q40-0H-00001)_497.31lm@250mA_P=4.5957W_I=0.250A

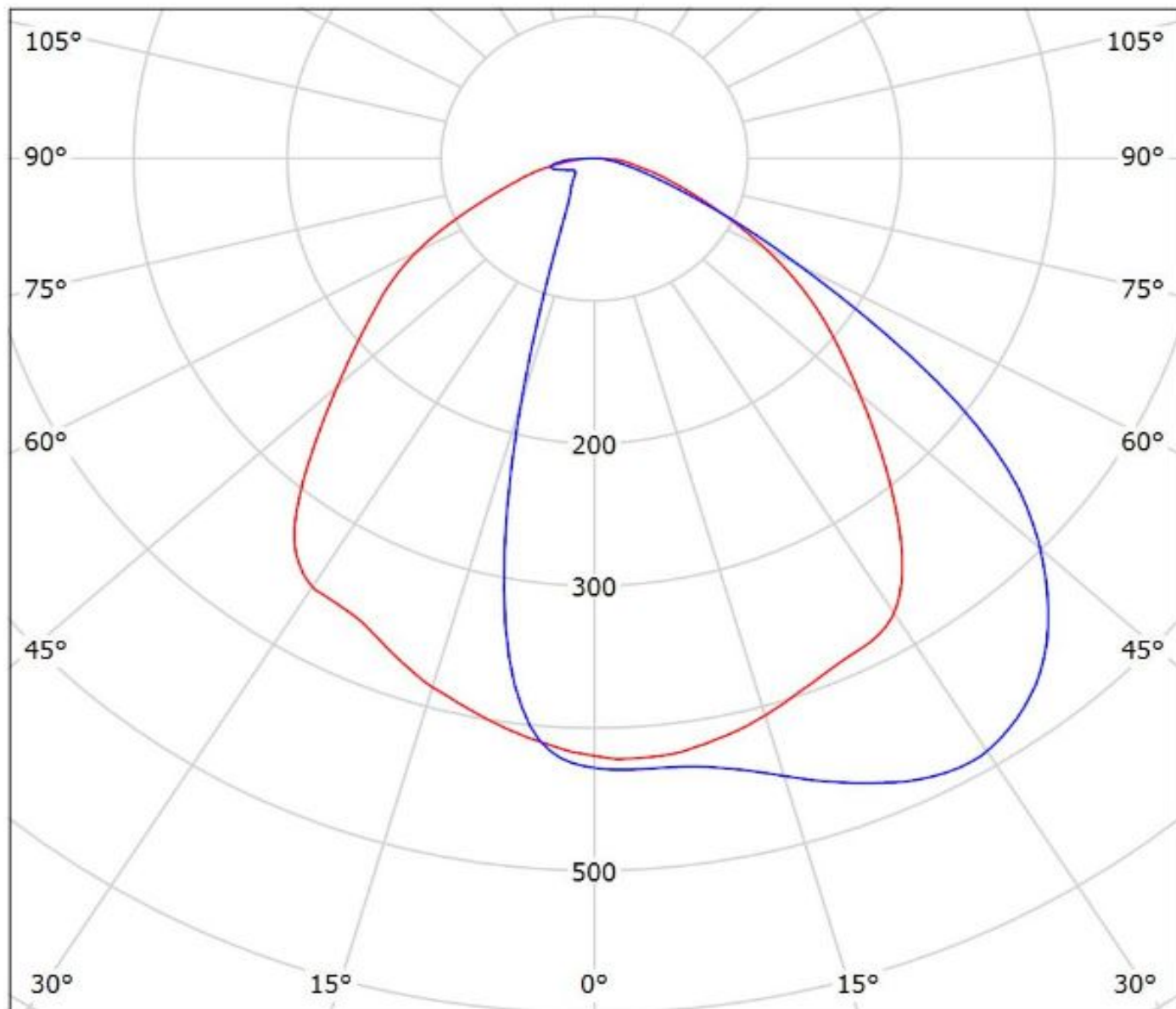

cd/klm

— C0 - C180 — C90 - C270

$\eta = 93\%$

Luminaire: LEDiL Oy C14275_SHELLY-T-6X1-N_(Luxeon_TX)

Lamps: 1 x Luxeon_TX_6x1_(L1T2-5770)_652.342lm@250mA_CCT=5700K_P=4.18365W_I=249.8mA

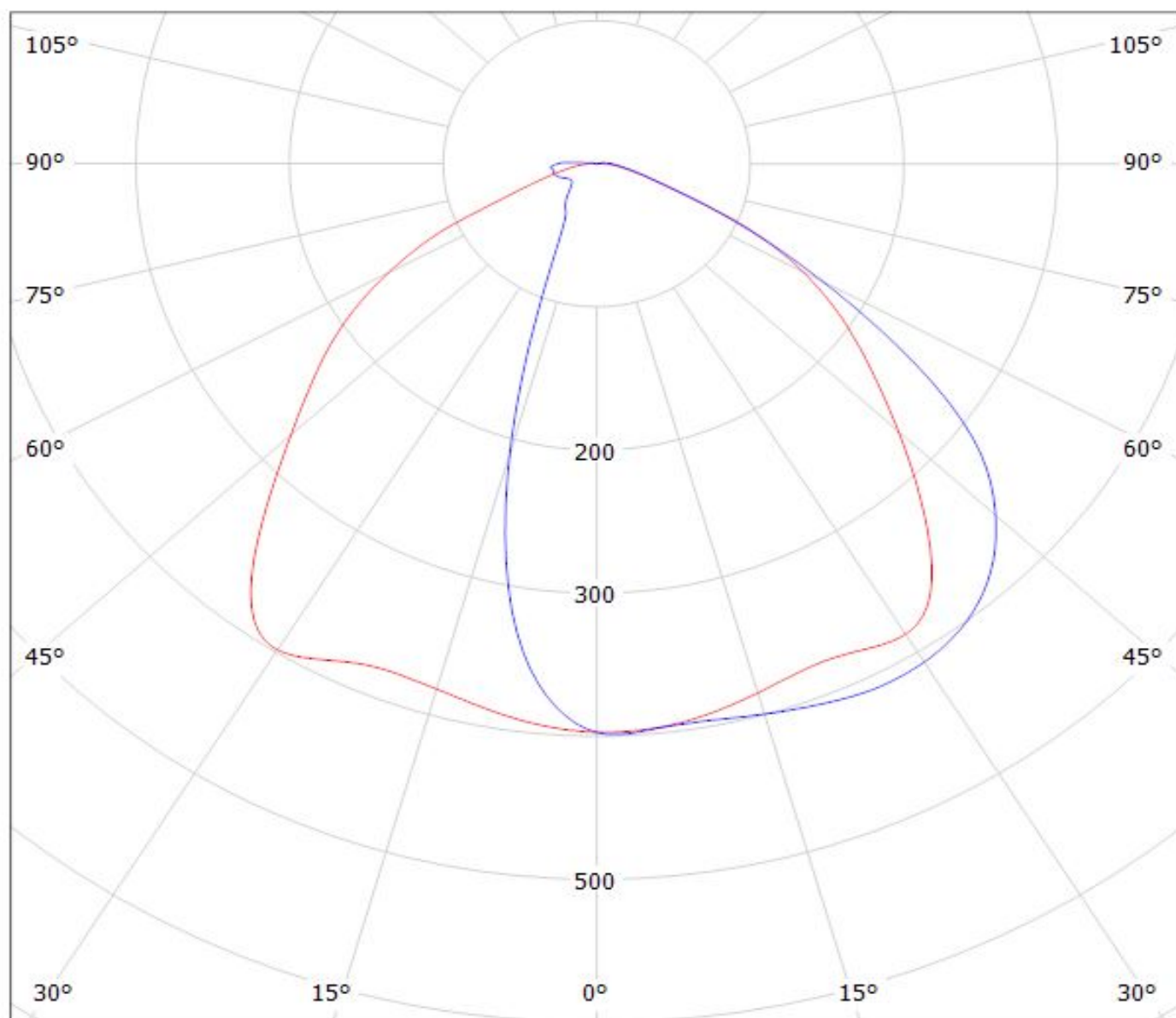

cd/klm

— C0 - C180

— C90 - C270

Luminaire: Ledil C14274_SHELLY-T-6X1-WAS_(Duris_S5_(2_chip))
Lamps: 1 x Osram_Duris_S5_(2_chip)_(PSLRS1EC-LQLS-5H7I-1)
_756.726lm@150mA_P=5.6W_I=0.150A

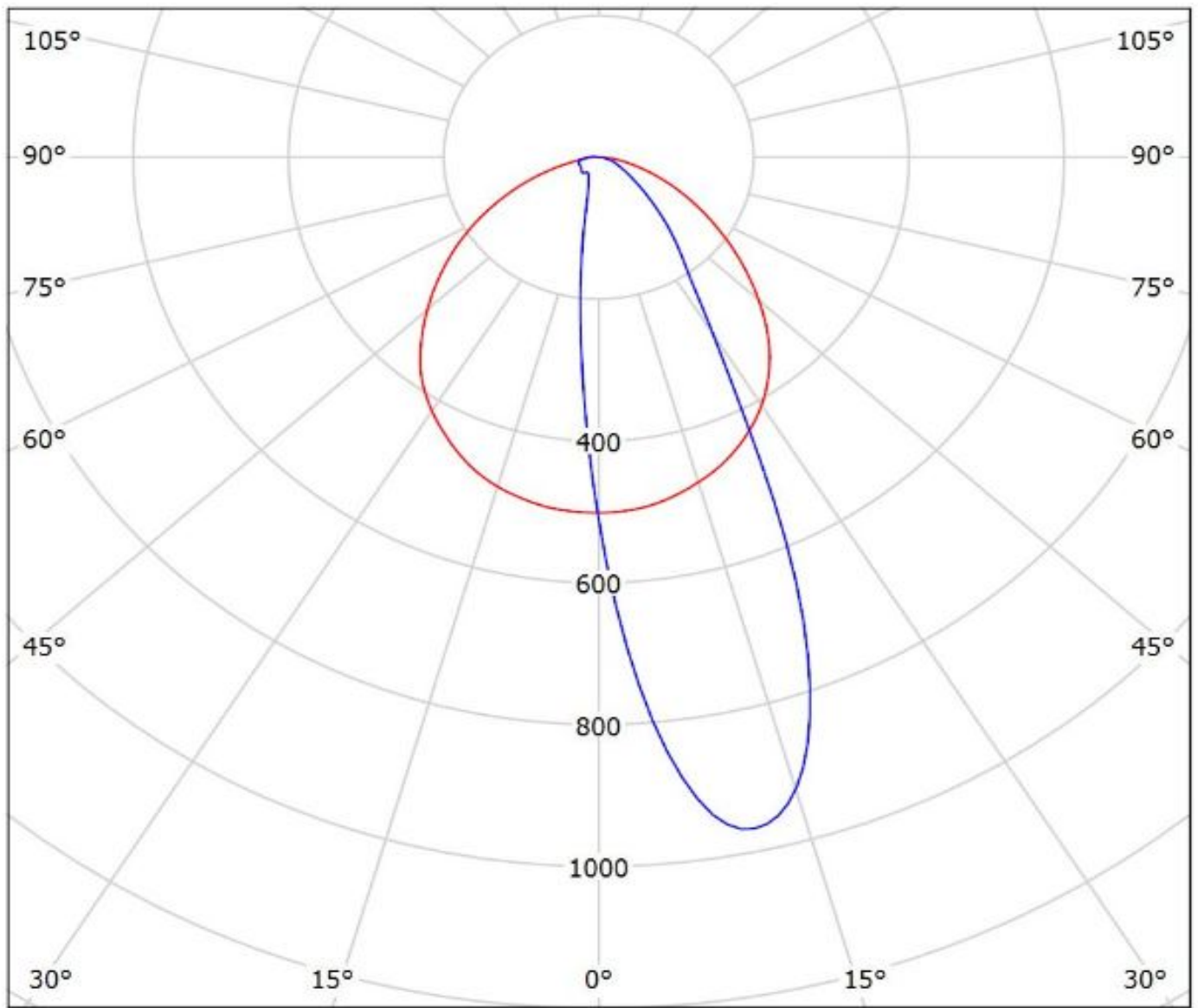

cd/klm

— C0 - C180 — C90 - C270

$\eta = 94\%$

Luminaire: LEDiL Oy C14275_SHELLY-T-6X1-N_(NCSxx19B) Eff.94.3%

Lamps: 1 x NCSxx19B_1x6_623.272lm@250mA_P=4.18008W_I=249.9mA

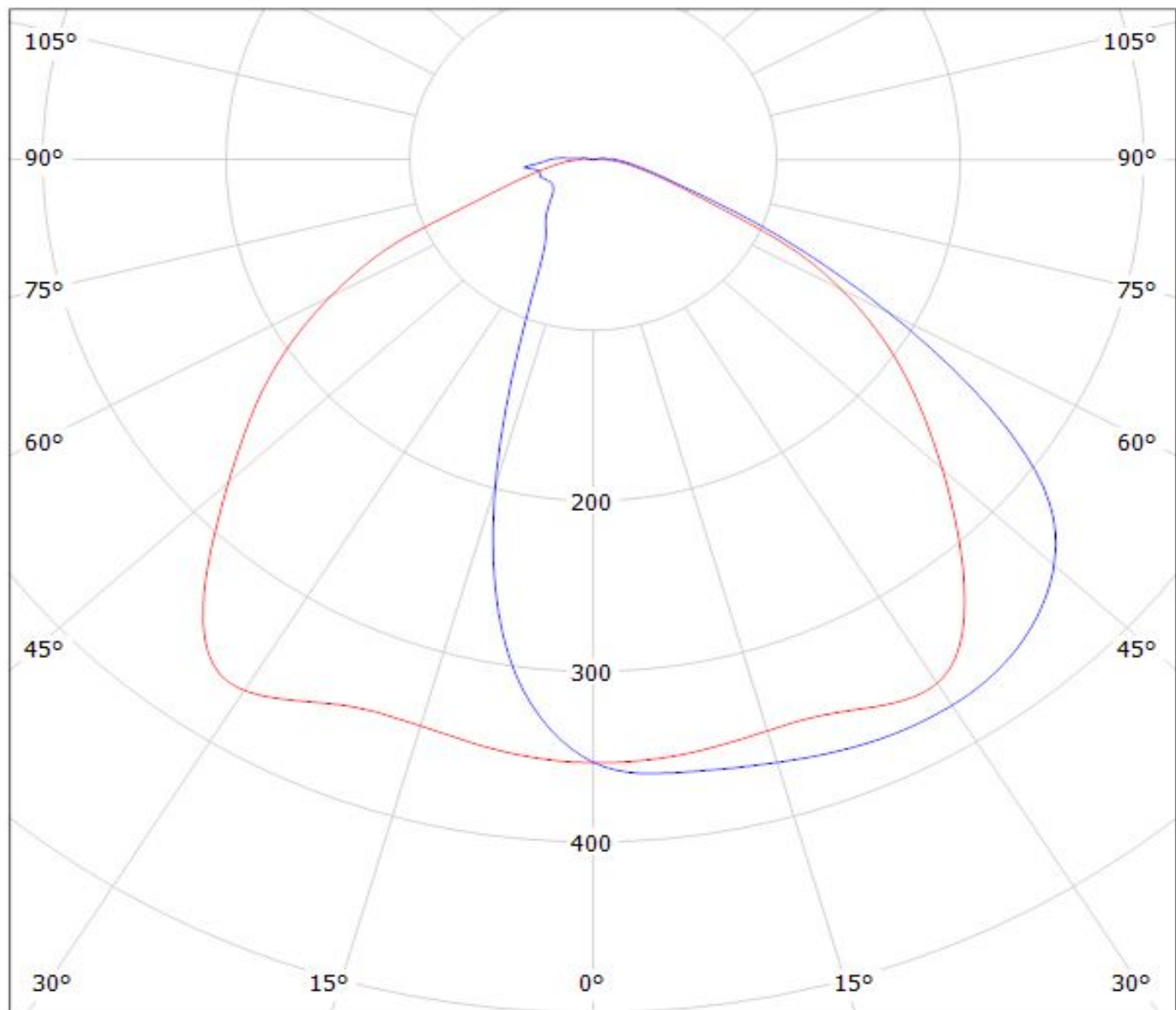

cd/klm

— C0 - C180

— C90 - C270

$\eta = 94\%$

Luminaire: LEDiL Oy C14275_SHELLY-T-6X1-N_(NVSxx19A) Eff.94.5%
Lamps: 1 x NVSxx19A_1x6_578.655lm@250mA_P=4.379W_I=249.9mA

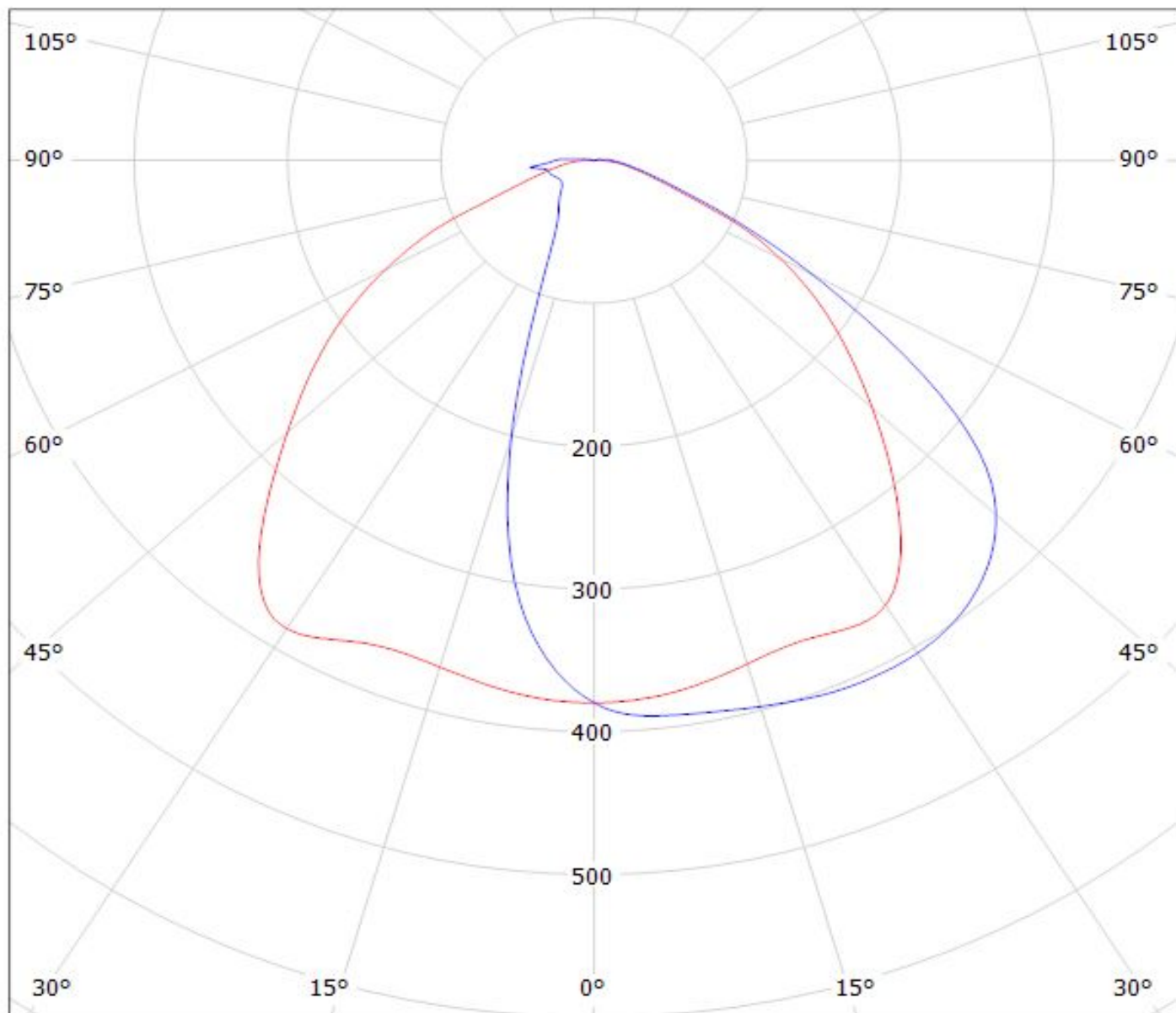

cd/klm

— C0 - C180 — C90 - C270

$\eta = 94\%$

Luminaire: LEDiL Oy C14275_SHELLY-T-6X1-N_(NVSxx19B)
Lamps: 1 x NVSxx19B_1x6_459.756lm@250mA_P=4.21581W_I=249.9mA

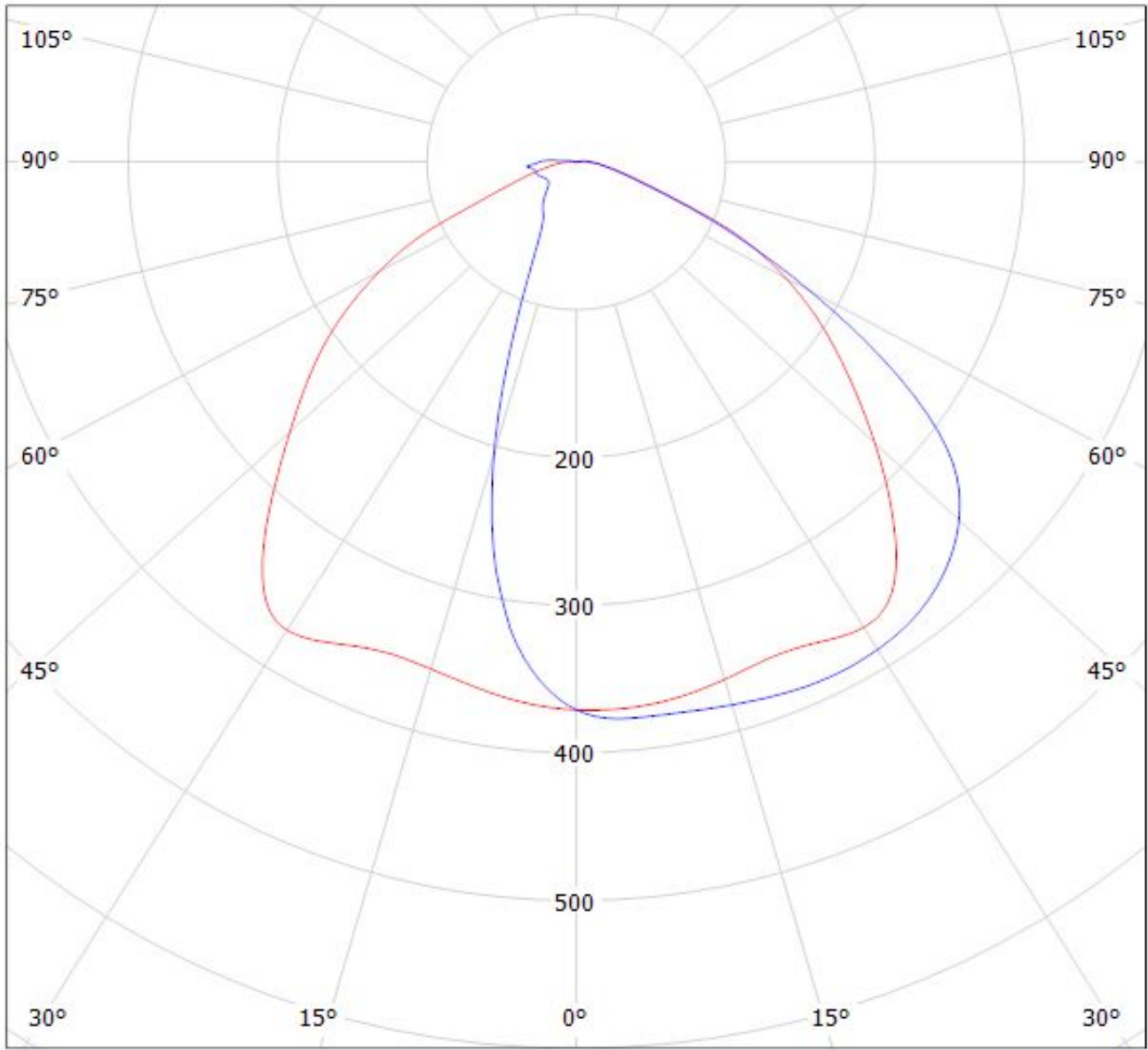

cd/klm

— C0 - C180 — C90 - C270

$\eta = 94\%$

Luminaire: Ledil C14275_SHELLY-T-6X1-N_(Luxeon_Z_ES)

Lamps: 1 x Luxeon_Z_ES_(LXZ2-4080-3)_534.9462lm@250mA_P=4.3941W_I=0.250A

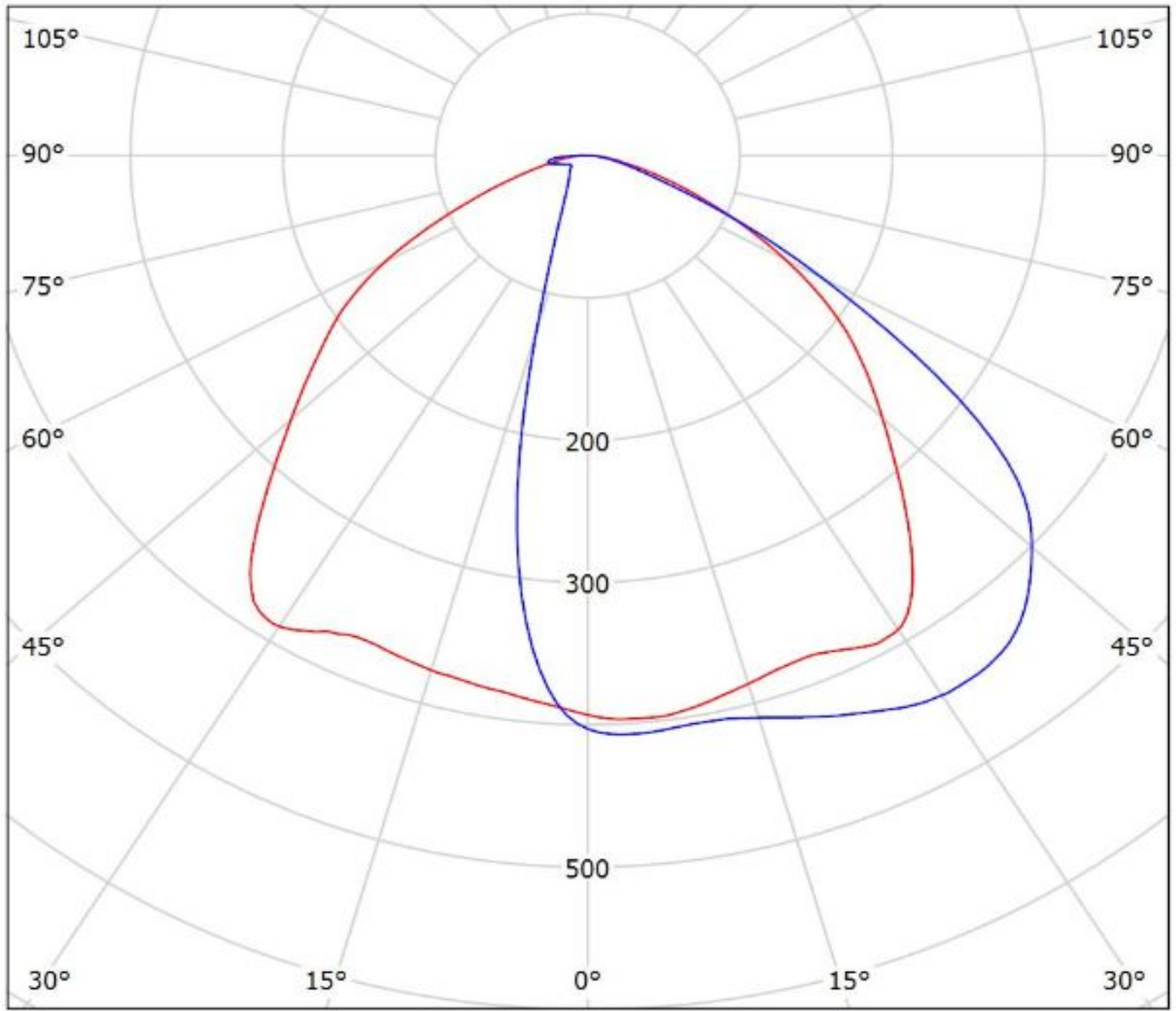

cd/klm

— C0 - C180 — C90 - C270

$\eta = 93\%$

Luminaire: LEDiL Oy C14275_SHELLY-T-6X1-N_(LUXEON_T)

Lamps: 1 x LUXEON_T_1x6_(LXH8-FW30-3)_433.852lm@250mA_P=4.17608W_I=249.9mA

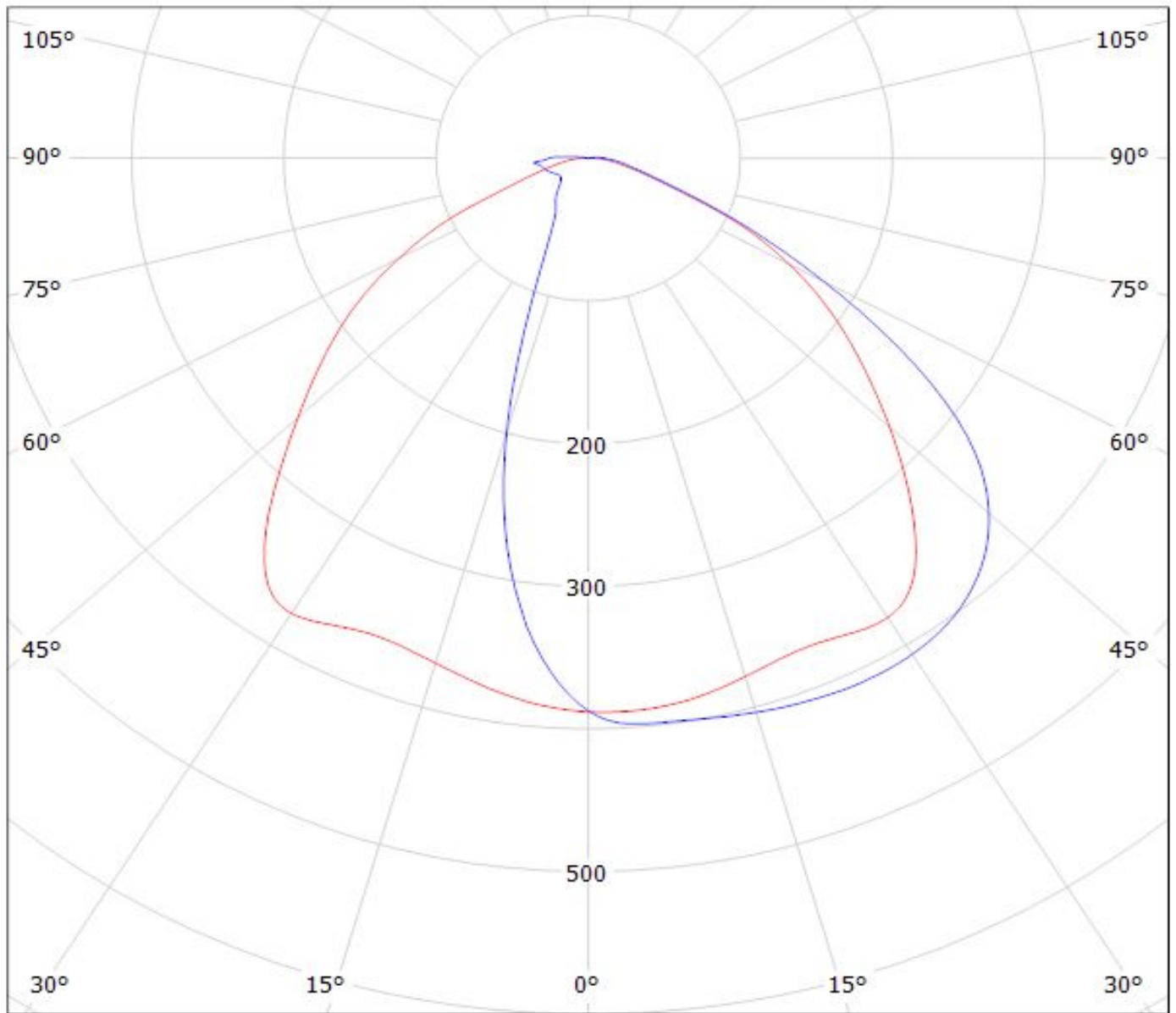

cd/klm

— C0 - C180

— C90 - C270

$\eta = 94\%$

Luminaire: LEDiL Oy C14275_SHELLY-T-6X1-N_(REBEL_ES)

Lamps: 1 x LUXEON_REBEL_ES_1x6_512.943lm@250mA_P=4.33102W_I=249.9mA

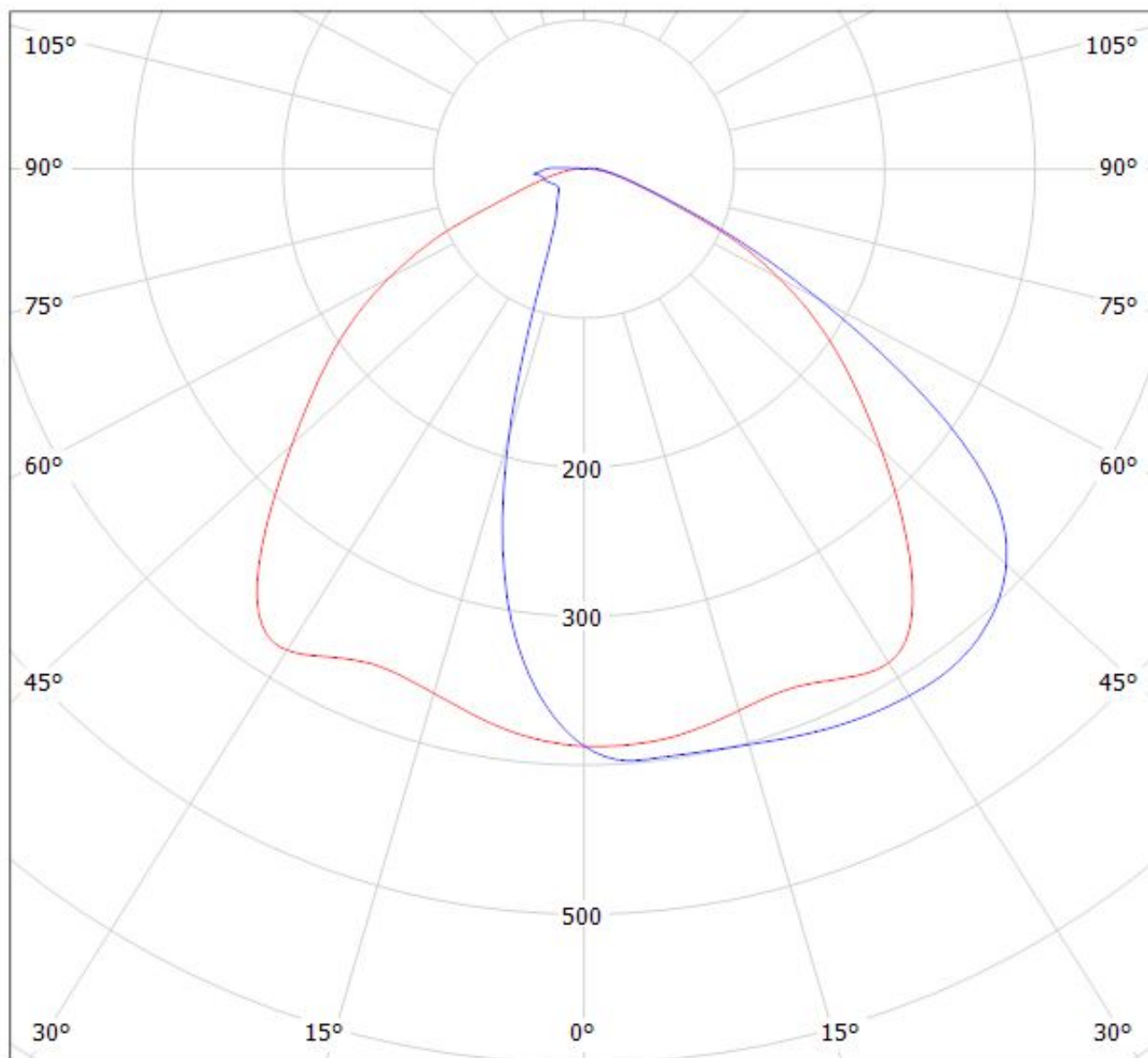

cd/klm

$\eta = 95\%$

— C0 - C180

— C90 - C270

Luminaire: LEDiL Oy C14275_SHELLY-T-6X1-N_(XB-D)

Lamps: 1 x CREE_XB-D_1x6_(XBDAAWT-00-0000_000_F51)_583.237lm@250mA_P=4.53544W_I=249.9mA

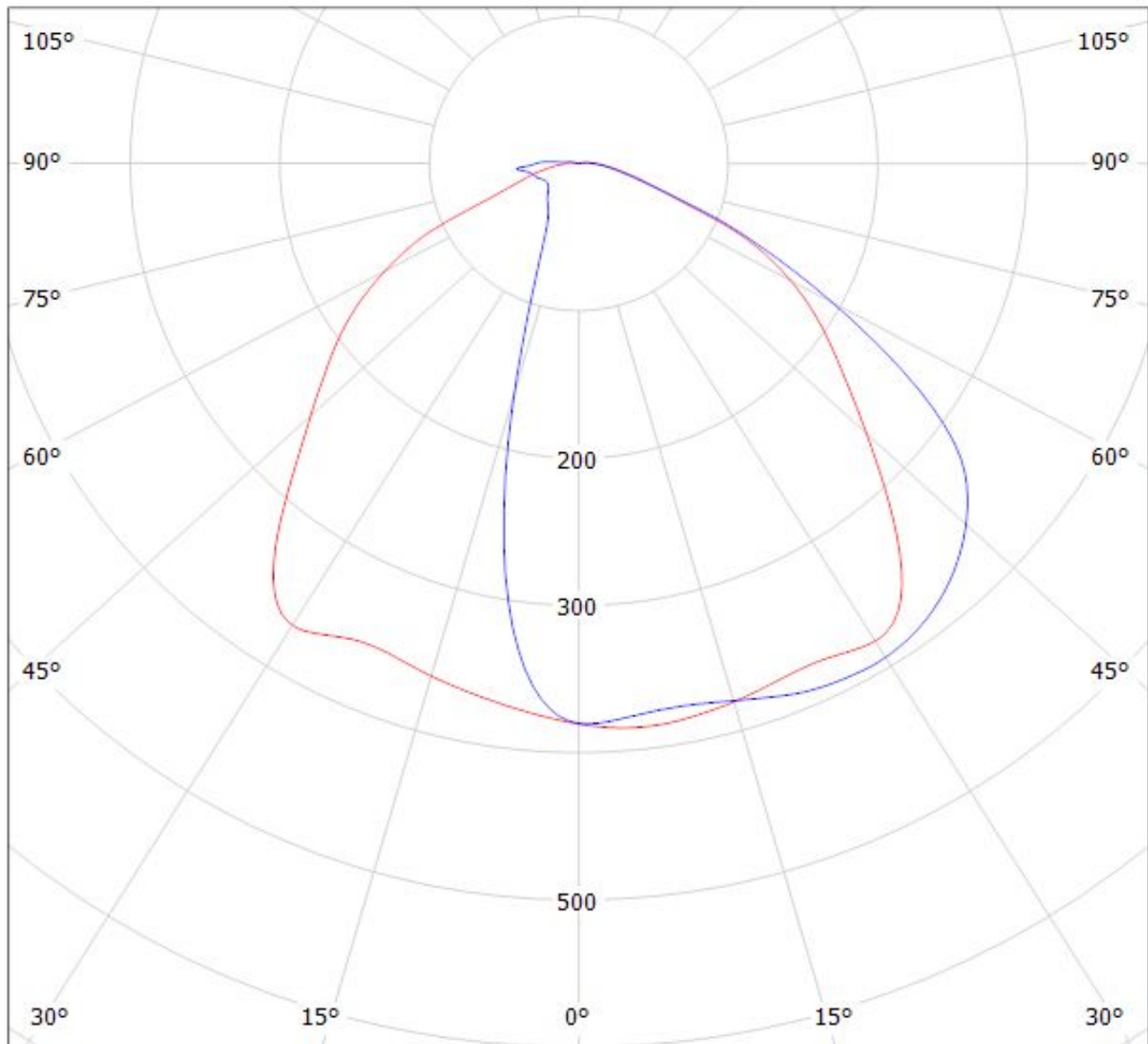

cd/klm

— C0 - C180

— C90 - C270

$\eta = 95\%$

Luminaire: LEDiL Oy C14275_SHELLY-T-6X1-N_(REBEL)

Lamps: 1 x LUXEON_REBEL_1x6_477.529lm@250mA_P=4.23231W_I=249.9mA

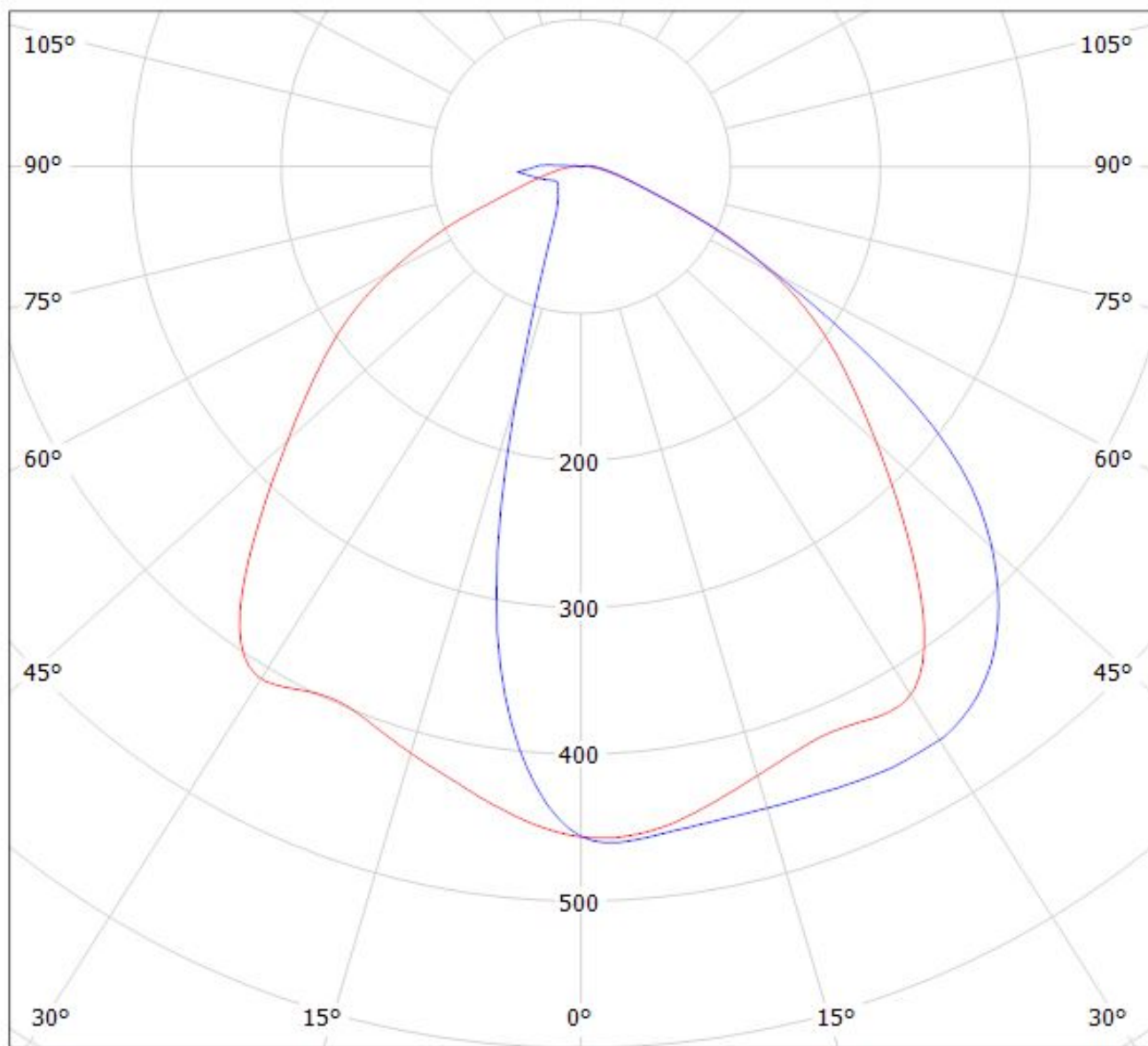

cd/klm

— C0 - C180

— C90 - C270

$\eta = 95\%$

NOTE: The typical divergence will be changed by different color, chip size and chip position tolerance. The typical total divergence is the full angle measured where the luminous intensity is half of the peak value.