

R82, Film, Metallized Polyester Stacked, Automotive Grade, 6800 pF, 10%, 400 VDC, 85°C, Lead Spacing = 5mm

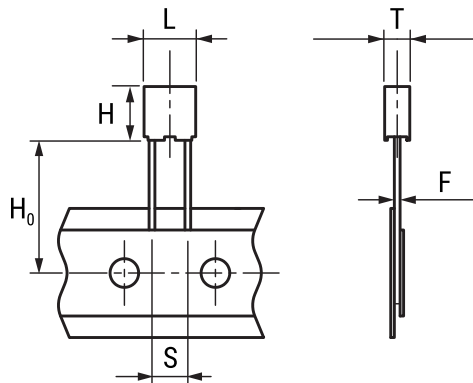

Dimensions	
L	7.2mm +0.2mm
H	7.5mm +0.1mm
T	3.5mm +0.1mm
S	5mm +0.6/-0.1mm
H0	18.5mm +/-0.5mm
F	0.5mm +/-0.05mm

Packaging Specifications	
Packaging:	Ammo, 360x340x59mm, Box
Packaging Quantity:	2500

General Information	
Supplier:	KEMET
Series:	R82
Dielectric:	Metallized Polyester Stacked
Style:	Radial
Features:	Automotive Grade, DC Multipurpose Applications
RoHS:	Yes
Lead:	Wire Leads
Qualifications:	AEC-Q200
AEC-Q200:	Yes
Miscellaneous:	Above 85C DC And AC Voltage Derating Is 1.25%/C

Specifications	
Capacitance:	6800 pF
Capacitance Tolerance:	10%
Voltage AC:	200 VAC
Voltage DC:	400 VDC
Temperature Range:	-55/+105C
Rated Temperature:	85°C
Dissipation Factor:	0.80% 1kHz, 1.20% 10kHz, 2.50% 100kHz
Insulation Resistance:	30 GOhms
Max dV/dt:	400 V/us
Inductance:	7 nH