

ADJUSTABLE HIGH PRECISION SHUNT REGULATOR

■GENERAL DESCRIPTION

The **NJM1431A** is a precision shunt regulator. Compared to the conventional 431, The **NJM1431A** offers higher voltage accuracy and small package availability to support a wide range of applications.

■PACKAGE OUTLINE

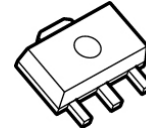

NJM1431AU

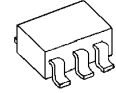

NJM1431AF



NJM1431AKF1

■FEATURES

- Operating Voltage V_{REF} to 36V
- Precision Voltage Reference $2.465V \pm 1\%$
- 1.6mm × 1.2mm to ESON4 package
- Adjustable Output Voltage
- Bipolar Technology
- Package Outline

NJM1431AU	: SOT89 (3pin)
NJM1431AF	: SOT-23-5 (MTP5)
NJM1431AKF1	: ESON4-F1

■BLOCK DIAGRAM

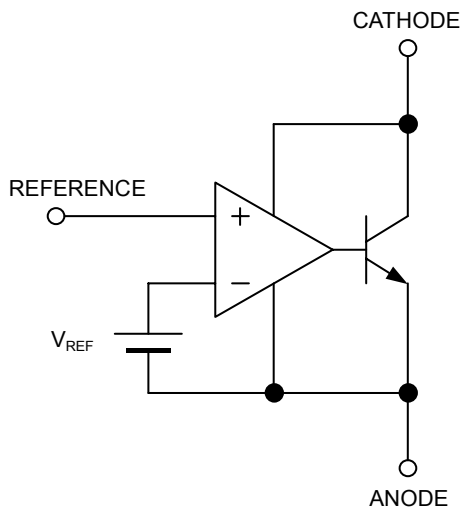

■PIN CONFIGURATION

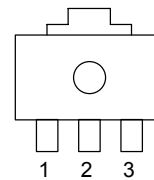

1. REFERENCE
2. ANODE
3. CATHODE

NJM1431AU

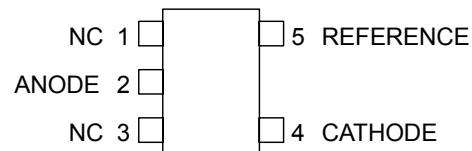

NJM1431AF

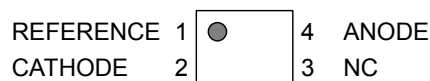

(Top View)

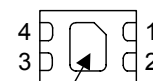

(Bottom View)

Exposed PAD on backside connect to ANODE.

NJM1431AKF1

NJM1431A

■ABSOLUTE MAXIMUM RATINGS (Ta=25°C)

PARAMETER	SYMBOL	MAXIMUM RATINGS	UNIT
Cathode Voltage	V_{KA}	+37	V
Continuous Cathode Current	I_K	-100 ~ 150	mA
Reference Input Current	I_{REF}	-0.05 ~ 10	mA
Power Dissipation	P_D	SOT89 (3pin) 350 SOT-23-5 200 ESON4-F1 412 (*1) 1,150 (*2)	mW
Operating Temperature Range	T_{OPR}	-40 ~ +85	°C
Storage Temperature Range	T_{STG}	-40 ~ +150	°C

(*1): Mounted on glass epoxy board based on EIA/JEDEC. (101.5 × 114.57 × 1.6mm: 2Layers)

(*2): Mounted on glass epoxy board based on EIA/JEDEC.

(101.5 × 114.57 × 1.6mm: 4Layers Internal foil area: 99.5 × 99.5mm)

■RECOMMENDED OPERATING CONDITIONS (Ta=25°C)

PARAMETER	SYMBOL	MIN.	TYP.	MAX.	UNIT
Cathode Voltage	V_{KA}	V_{REF}	—	36	V
Cathode Current	I_K	1	—	100	mA

■ELECTRICAL CHARACTERISTICS ($I_K=10mA$, Ta=25°C)

PARAMETER	SYMBOL	TEST CONDITION	MIN.	TYP.	MAX.	UNIT
Reference Voltage	V_{REF}	$V_{KA}=V_{REF}$ (*3)	2.440	2.465	2.490	V
Reference Voltage Change vs. Cathode Voltage Change	$\Delta V_{REF}/\Delta V_{KA}$	$ V_{REF} \leq V_{KA} \leq 10V$ (*4)	—	±1.4	±2.7	mV/V
		$10V \leq V_{KA} \leq 36V$ (*4)	—	±1.0	±2.0	mV/V
Reference Input Current	I_{REF}	$R1=10k\Omega$, $R2=\infty$ (*4)	—	2	4	uA
Minimum Input Current	I_{MIN}	$V_{KA}=V_{REF}$, $\Delta V_{REF}=1\%$ (*3)	—	0.4	1.0	mA
Cathode Current (Off Cond.)	I_{OFF}	$V_{KA}=36V$, $V_{REF}=0V$ (*5)	—	0.1	1.0	uA
Dynamic Impedance	$ Z_{KA} $	$V_{KA}=V_{REF}$, $f \leq 1kHz$ $1mA \leq I_K \leq 100mA$ (*3)	—	0.2	0.5	Ω

■TEMPERATURE CHARACTERISTICS ($I_K=10mA$, Ta= -40°C ~ 85°C)

PARAMETER	SYMBOL	TEST CONDITION	MIN.	TYP.	MAX.	UNIT
Reference Voltage Change	ΔV_{REF}	$V_{KA}=V_{REF}$ (*3)	—	8	17	mV
Reference Input Current Change	ΔI_{REF}	$R1=10k\Omega$, $R2=\infty$ (*4)	—	0.4	1.2	uA

The maximum value of “Dynamic Impedance”, “Reference Voltage Change” and “Reference Input Current Change” are determined based on sampling evaluation from the 5 initial production lots, and thus not tested in the production test.

Therefore, these values are for the reference design purpose only.

$|V_{REF}|$...Reference voltage includes error.

(*3): Test Circuit (Fig.1)

(*4): Test Circuit (Fig.2)

(*5): Test Circuit (Fig.3)

■TEST CIRCUIT

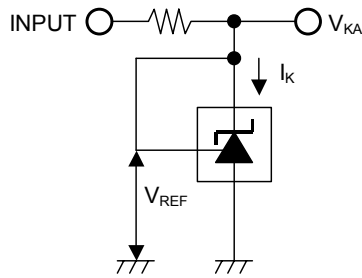

Fig.1 $V_{KA}=V_{REF}$ to test circuit

$$V_O = V_{KA} = V_{REF}$$

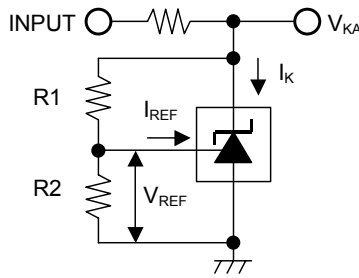

Fig.2 $V_{KA} > V_{REF}$ to test circuit

$$V_O = V_{KA} = V_{REF} \left(1 + \frac{R1}{R2} \right) + I_{REF} \times R1$$

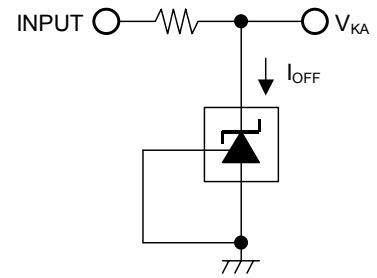
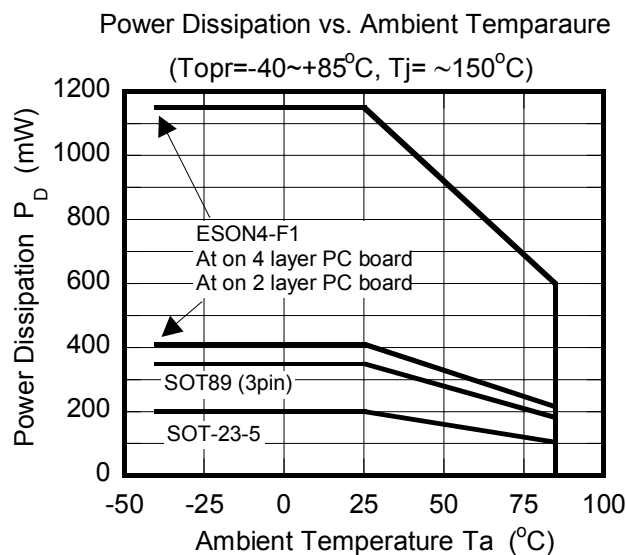

Fig.3 I_{OFF} to test circuit

■POWER DISSIPATION VS. AMBIENT TEMPERATURE



NJM1431A

■ TYPICAL CHARACTERISTICS

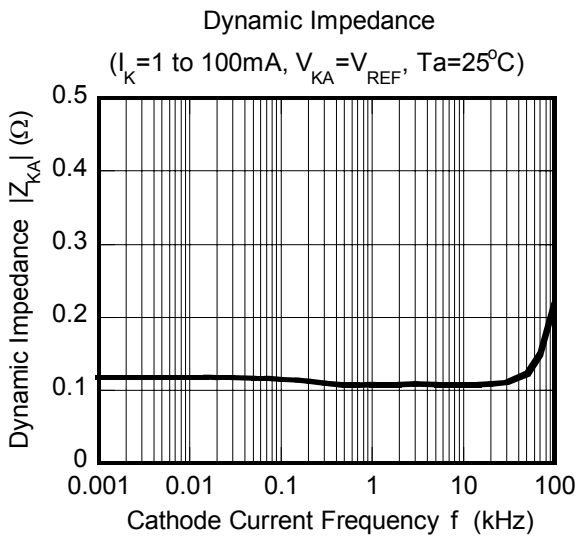
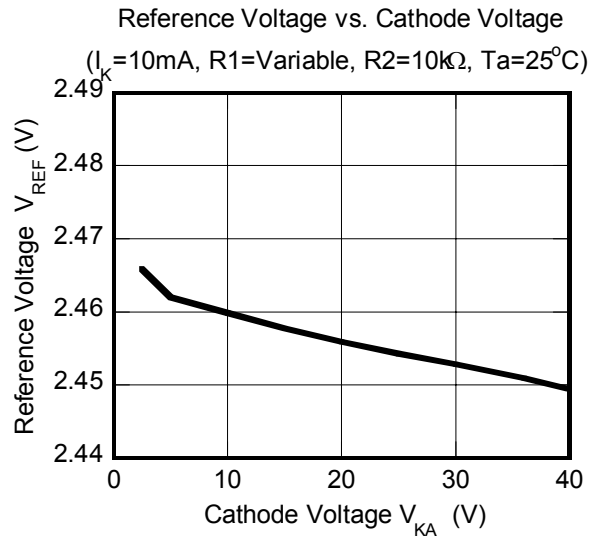
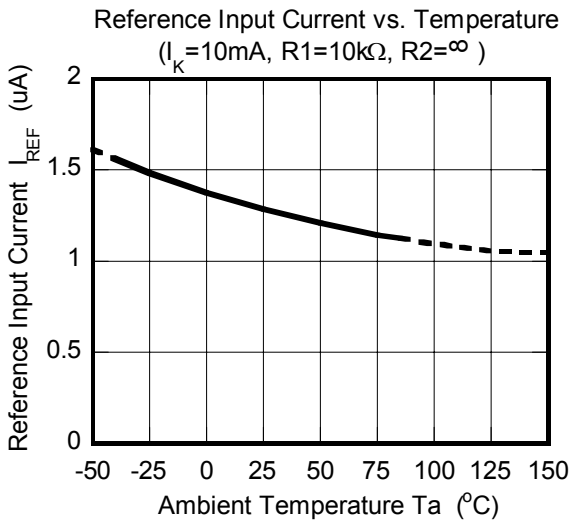
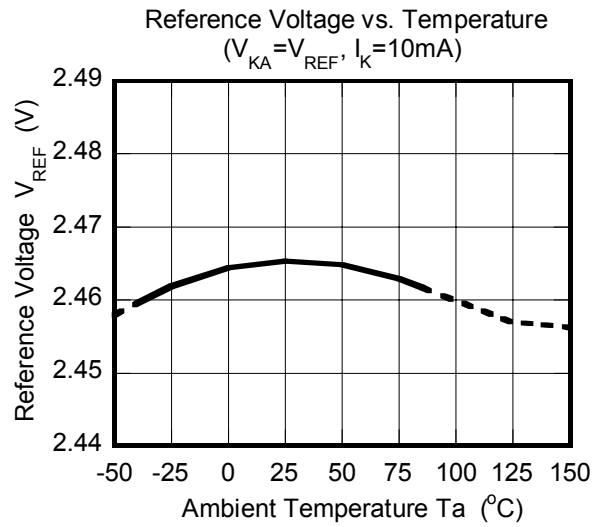
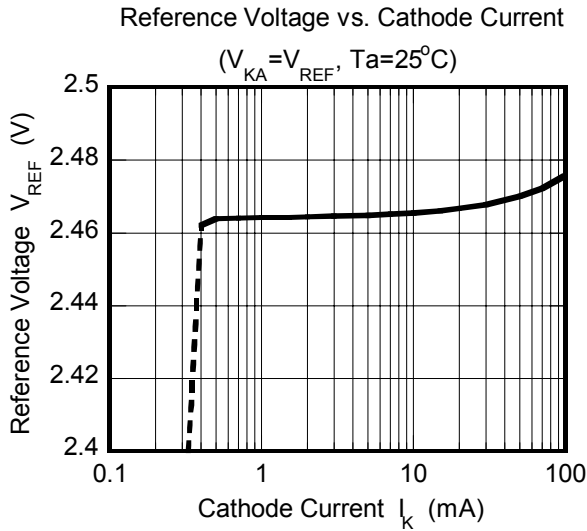

■ TYPICAL CHARACTERISTICS

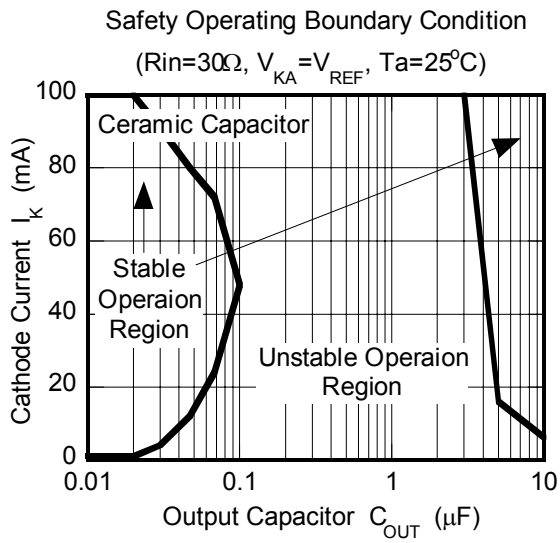

Safety Operating Boundary Condition
Test Circuit

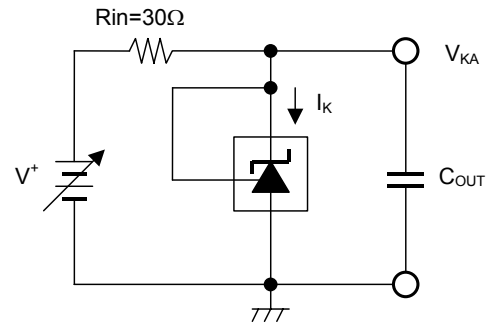

Note) Oscillation might occur while operating within the range of safety curve.

So that, it is necessary to make ample margins by taking considerations of fluctuation of the device.

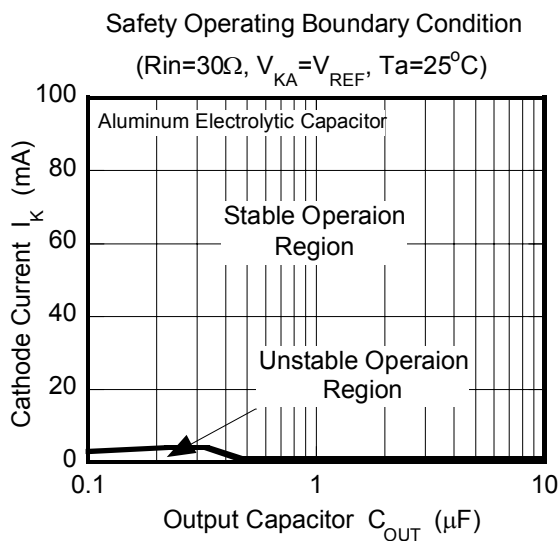

MEMO

[CAUTION]

The specifications on this databook are only given for information, without any guarantee as regards either mistakes or omissions. The application circuits in this databook are described only to show representative usages of the product and not intended for the guarantee or permission of any right including the industrial rights.