

ZB5AA56

yellow recessed pushbutton head Ø22 spring return unmarked



Main

| | |
|---------------------------------|--------------------------------------|
| Range of product | Harmony XB5 |
| Product or component type | Head for non-illuminated push-button |
| Device short name | ZB5 |
| Bezel material | Plastic |
| Mounting diameter | 22 mm |
| Sale per indivisible quantity | 1 |
| Shape of signaling unit head | Round |
| Type of operator | Spring return |
| Operator profile | Yellow recessed unmarked |
| Operator additional information | High guard |

Complementary

| | |
|-----------------------------|---|
| CAD overall width | 29 mm |
| CAD overall height | 29 mm |
| CAD overall depth | 31 mm |
| Product weight | 0.02 kg |
| Mechanical durability | 10000000 cycles |
| Station name | XALD 1...5 cut-outs XALK 2...5 cut-outs |
| Electrical composition code | C1 for <= 9 contacts using single blocks in front mounting C2 for <= 9 contacts using single and double blocks in front mounting C11 for <= 3 contacts using single blocks in front mounting C15 for 1 contacts using single blocks in front mounting SF1 for <= 3 contacts using single blocks in front mounting SR1 for <= 3 contacts using single blocks in rear mounting |

Environment

| | |
|---------------------------------------|---|
| protective treatment | TH |
| ambient air temperature for storage | -40...70 °C |
| ambient air temperature for operation | -40...70 °C |
| overvoltage category | Class II conforming to IEC 60536 |
| IP degree of protection | IP67 IP66 conforming to IEC 60529 IP69K IP69 |
| NEMA degree of protection | NEMA 13 NEMA 4X |
| resistance to high pressure washer | 7000000 Pa at 55 °C, distance: 0.1 m |
| IK degree of protection | IK03 conforming to IEC 50102 |
| standards | EN/IEC 60947-1 EN/IEC 60947-5-1 EN/IEC 60947-5-4 JIS C 4520 UL 508 CSA C22.2 No 14 |
| product certifications | BV CSA DNV GL LROS (Lloyds register of shipping) RINA UL listed |
| shock resistance | 30 gn (duration = 18 ms) for half sine wave acceleration conforming to IEC 60068-2- |

The information provided in this documentation contains general descriptions and/or technical characteristics of the products contained herein. This documentation is not intended as a substitute for and is not to be used for determining suitability or reliability of these products for specific user applications. It is the duty of any such user or integrator to perform the appropriate and complete risk analysis, evaluation and testing of the products with respect to the relevant specific application or use thereof. Neither Schneider Electric Industries SAS nor any of its affiliates or subsidiaries shall be responsible or liable for misuse of the information contained herein.

27
 50 gn (duration = 11 ms) for half sine wave acceleration conforming to IEC 60068-2-27

vibration resistance 5 gn (f = 2...500 Hz) conforming to IEC 60068-2-6

Contractual warranty

Warranty period 18 months

Dimensions

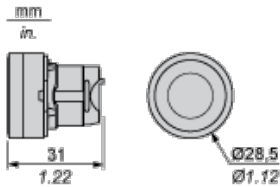

Panel Cut-out for Pushbuttons, Switches and Pilot Lights (Finished Holes, Ready for Installation)

Connection by Screw Clamp Terminals or Plug-in Connectors or on Printed Circuit Board

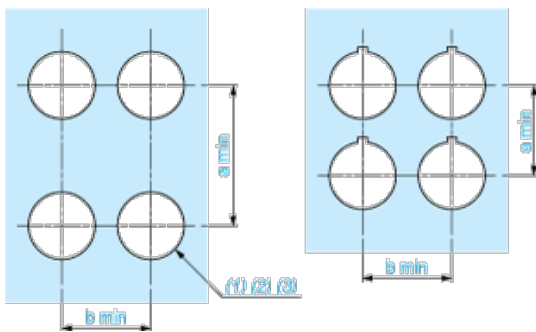

- (1) Diameter on finished panel or support
- (2) For selector switches and Emergency stop buttons, use of an anti-rotation plate type ZB5AZ902 is recommended.
- (3) $\varnothing 22.5$ mm recommended ($\varnothing 22.3_{0}^{+0.4}$) / $\varnothing 0.89$ in. recommended ($\varnothing 0.88$ in. $_{0}^{+0.016}$)

| Connections | a in mm | a in in. | b in mm | b in in. |
|---|---------|----------|---------|----------|
| By screw clamp terminals or plug-in connector | 40 | 1.57 | 30 | 1.18 |
| By Faston connectors | 45 | 1.77 | 32 | 1.26 |
| On printed circuit board | 30 | 1.18 | 30 | 1.18 |

Detail of Lug Recess

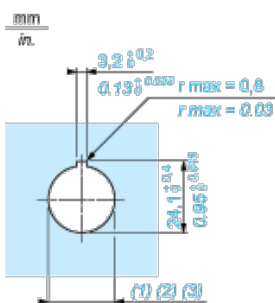

- (1) Diameter on finished panel or support
- (2) For selector switches and Emergency stop buttons, use of an anti-rotation plate type ZB5AZ902 is recommended.
- (3) $\varnothing 22.5$ mm recommended ($\varnothing 22.3_{0}^{+0.4}$) / $\varnothing 0.89$ in. recommended ($\varnothing 0.88$ in. $_{0}^{+0.016}$)

Pushbuttons, Switches and Pilot Lights for Printed Circuit Board Connection

Panel Cut-outs (Viewed from Installer's Side)

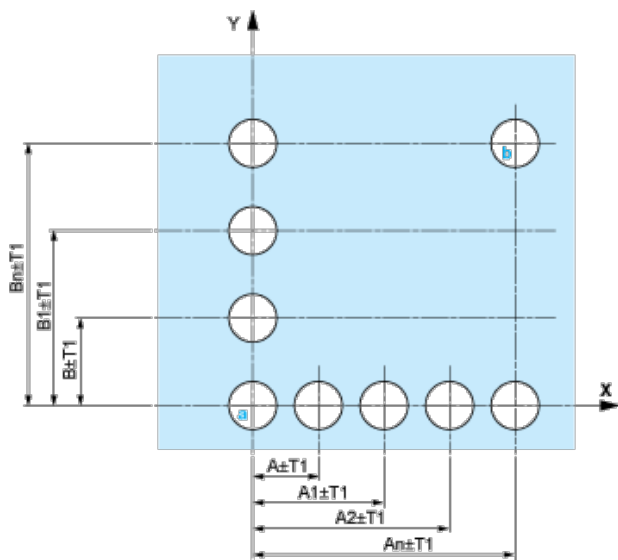

A: 30 mm min. / 1.18 in. min.

B: 40 mm min. / 1.57 in. min.

Printed Circuit Board Cut-outs (Viewed from Electrical Block Side)

Dimensions in mm

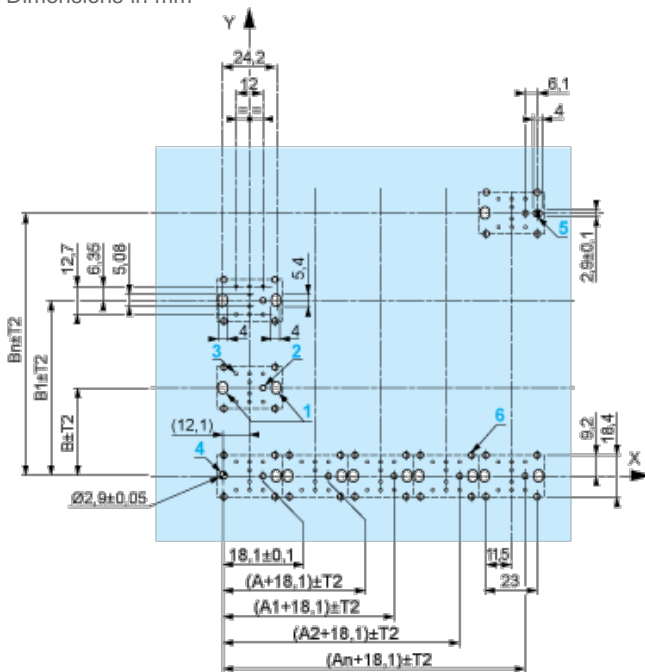

A: 30 mm min.

B: 40 mm min.

Dimensions in in.

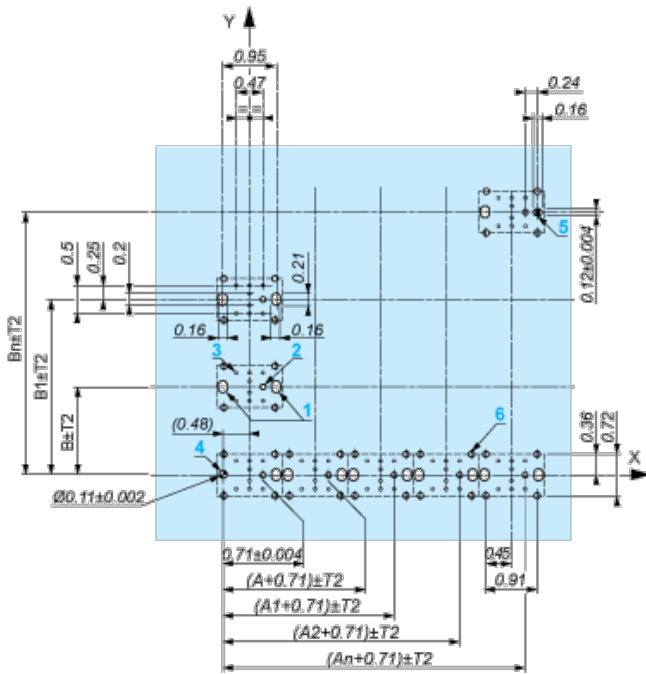

A: 1.18 in. min.

B: 1.57 in. min.

General Tolerances of the Panel and Printed Circuit Board

The cumulative tolerance must not exceed 0.3 mm / 0.012 in.: $T1 + T2 = 0.3 \text{ mm max.}$

Installation Precautions

- | Minimum thickness of circuit board: 1.6 mm / 0.06 in.
- | Cut-out diameter: 22.4 mm \pm 0.1 / 0.88 in. \pm 0.004
- | Orientation of body/fixing collar ZB5AZ009: \pm 2°30' (excluding cut-outs marked **a** and **b**).
- | Tightening torque of screws ZBZ006: 0.6 N.m (5.3 lbf.in) max.
- | Allow for one ZB5AZ079 fixing collar/pillar and its fixing screws:
 - | every 90 mm / 3.54 in. horizontally (X), and 120 mm / 4.72 in. vertically (Y).
 - | with each selector switch head (ZB5AD•, ZB5AJ•, ZB5AG•).

The fixing centers marked **a** and **b** are diagonally opposed and must align with those marked **4** and **5**.



- (1) Head ZB5AD•
- (2) Panel
- (3) Nut
- (4) Printed circuit board

Mounting of Adapter (Socket) ZBZ01•

- | 1 2 elongated holes for ZBZ006 screw access
- | 2 1 hole \varnothing 2.4 mm \pm 0.05 / 0.09 in. \pm 0.002 for centring adapter ZBZ01•
- | 3 8 \times \varnothing 1.2 mm / 0.05 in. holes
- | 4 1 hole \varnothing 2.9 mm \pm 0.05 / 0.11 in. \pm 0.002, for aligning the printed circuit board (with cut-out marked **a**)

- | 5 1 elongated hole for aligning the printed circuit board (with cut-out marked **b**)
- | 6 4 holes \varnothing 2.4 mm / 0.09 in. for clipping in adapter ZBZ01•

Dimensions An + 18.1 relate to the \varnothing 2.4 mm \pm 0.05 / 0.09 in. \pm 0.002 holes for centring adapter ZBZ01•.

Electrical Composition Corresponding to Code C1



Electrical Composition Corresponding to Code C2



Electrical Composition Corresponding to Codes C9, C11, SF1 and SR1



Electrical Composition Corresponding to Code C15

1 N/O



1 N/C



1 N/O + N/C or 1 N/O + N/O or 1 N/C + N/C

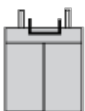

Legend

Single contact



Double contact



Light block



Possible location

