

3 Way PCB  
 Connection Module

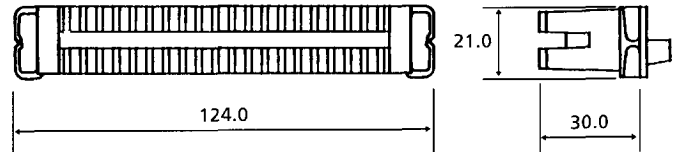

10 Pair Module

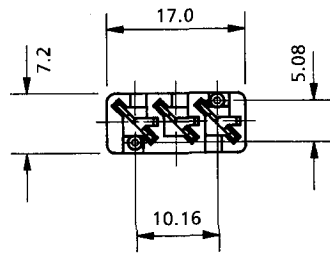
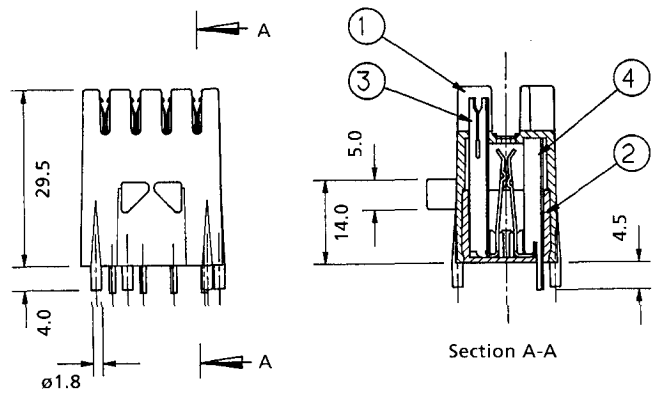

2 Pair Disconnection Module

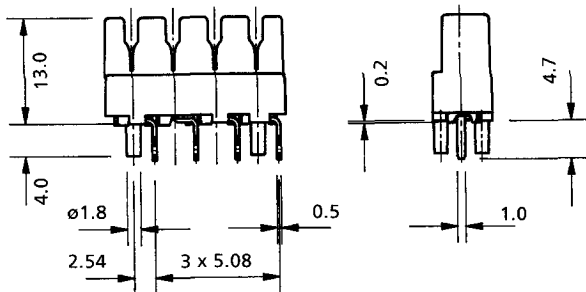

4 Way PCB  
 Connection Module

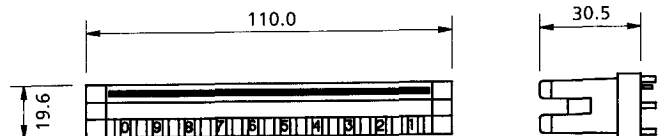
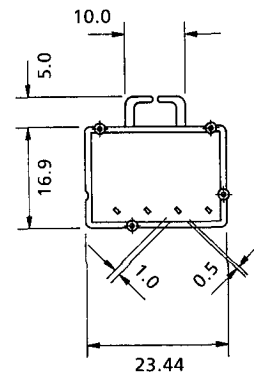
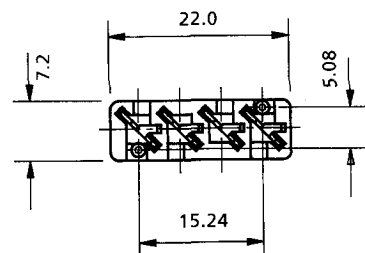

6426/2/056/01



6426/2/056/00

10 Pair PCB  
 Disconnection  
 Module

Description KRONE No

**Disconnection Module**

- 10 pair disconnection contacts, cream (*pictured*).

**BT Ref.:** Strips Connexion 237A

6089/1/810/00

- 10 pair disconnection contacts, green.
- 10 pair disconnection contacts, blue.

6089/1/811/00

6089/1/812/00  
Pack Qty **10**

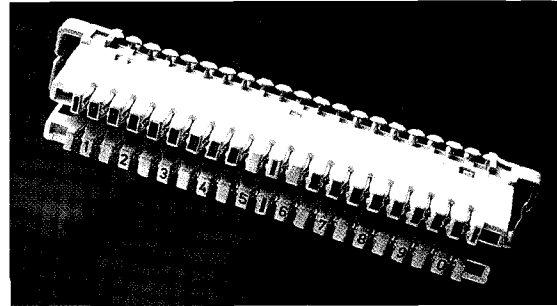
**Connection Module**

- 10 pair connection contacts

**BT Ref.:** Strips Connexion 237B

6089/1/820/00

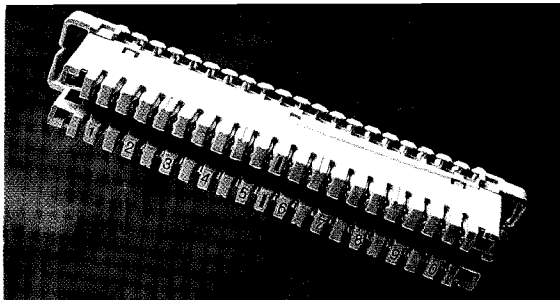

- 20 pair isolated disconnection contacts, no test access.

**BT Ref.:** Strips Connexion 237C

6089/1/830/00  
Pack Qty **10**

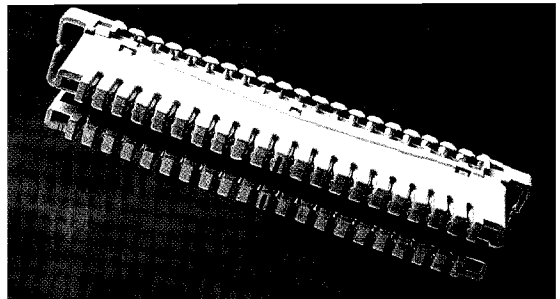
**Earth Module (red)**

- 76 way, earth lead and terminal ring, red

**BT Ref.:** Strips Connexion 237D

6089/1/840/00

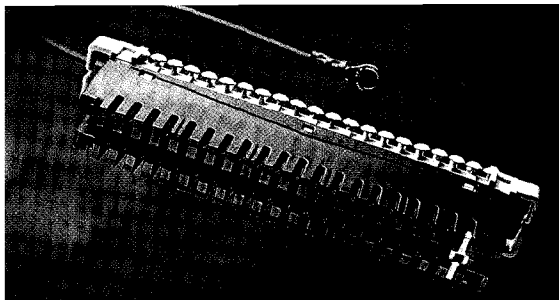

- 20 way, earth lead and terminal ring, red

**BT Ref.:** Strips Connexion 237E

6089/1/841/00  
Pack Qty **10**

