

ITP160x50-Ø20 flat

EAN 4031582070323

Wheel centre made of Aluminium, Tread:
Polyurethane, casted, precision ball bearing

Technical Data	
Wheel diameter	160 mm
Width of Tread	50 mm
Axle Hole-Ø	20 mm
Hub length	60 mm
Temperature	- 20 / + 60 °C
Standard	EN 12532
Weight	1.1 kg
Hardness of tread	A 92 Shore
Load capacity	800 kg
Load capacity (static)	1600 kg



Roll performance	+	+	+	+	+
Movement noise	+	+	+	+	+
Attrition	+	+	+	+	+
Corrosion resistance	+	+	+	+	+

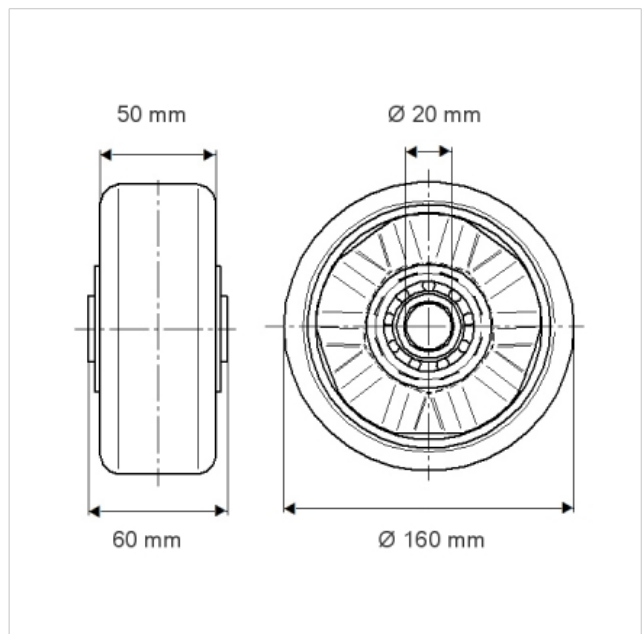



ITP160x50-Ø20 flat

EAN 4031582070323

