

T110, Tantalum, MnO2 Tantalum, Commercial Grade, 10 uF, 10%, 35 VDC, 2 Ohms

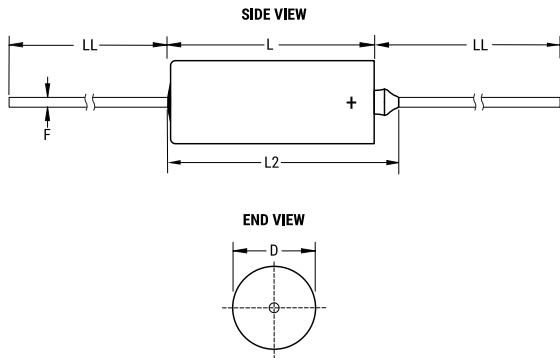

Dimensions	
D	7.34mm +/-0.25mm
L	17.42mm +/-0.79mm
L2	20.88mm
LL	38.1mm +/-6.35mm
F	0.64mm +/-0.05mm

Packaging Specifications	
Packaging:	Bulk, Tray
Packaging Quantity:	20

General Information	
Supplier:	KEMET
Series:	T110
Dielectric:	MnO2 Tantalum
Style:	Axial Hermetic
Description:	Axial, Solid Tantalum, Hermetically Sealed, Military (Non-ER), Polar
Features:	Polar
RoHS:	Yes
Termination:	Tin
Lead:	Wire Leads
Construction:	Hermetic
Notes:	Dimensions Include Insulation Sleeve. When Supplied On T&R Or Ammo, Lead Length Is Determined By Taping Specification

Specifications	
Capacitance:	10 uF
Capacitance Tolerance:	10%
Voltage DC:	35 VDC (85C), 28 VDC (125C Surge), 0.35 VDC (125C Reverse)
Temperature Range:	-55/+125C
Rated Temperature:	85°C
Resistance:	2 Ohms (100kHz)
Leakage Current:	3 uA (25C)