



ENGLISH

Datasheet

DC Axial Fan, 80 x 80 x 25mm, 48m/h, 0.96W, 24 V dc (OD8025 Series)

RS Stock number [541-5283](#)



Frame and Impeller

PBT, UL94V-0 Thermoplastic

Available Options

Tachometer

Locked Rotor Alarm

Finger Guard: G80-18

Plastic Guard: G80P

Wire Mesh Guard: WMG80M

Filter Kit: GRM80-30, GRM80-45

RS Part Number	Orion Part Number	Speed (RPM)	Airflow (CFM)	Noise (db)	Volts (DC)	Voltage Range	Current (Amps)	Lead Type
5415053	OD8025-12HB	3300	40	33	12	6~13.8	0.25	Wire
5415047	OD8025-12MB	2800	33	28	12	6~13.8	0.15	Wire
5415031	OD8025-12LB	2000	28	21	12	6~13.8	0.12	Wire
5415306	OD8025-24HB	3300	40	33	24	12~28	0.16	Wire
5415299	OD8025-24MB	2800	33	28	24	12~28	0.1	Wire
5415283	OD8025-24LB	2000	28	21	24	12~28	0.09	Wire

Data Tolerance +/- 10%

Drawing(mm):

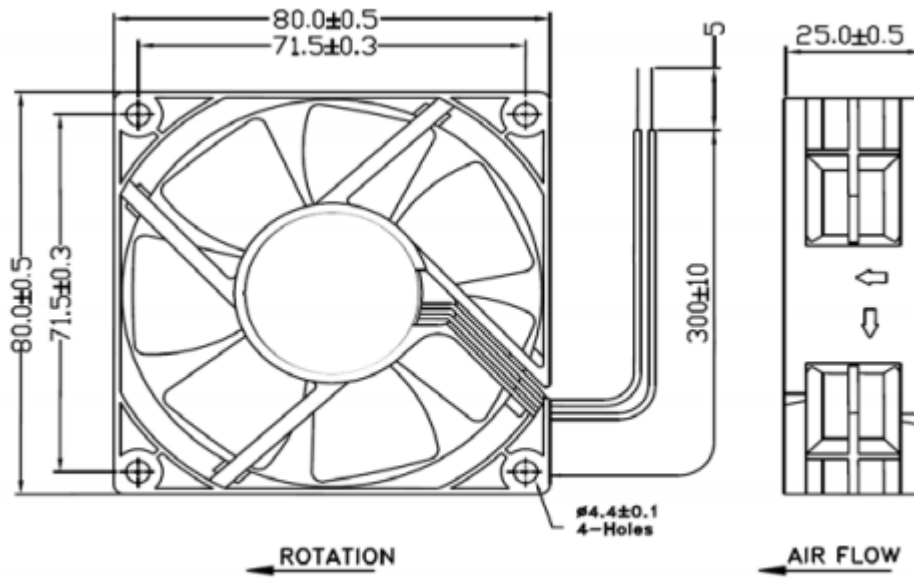

*Drawing for Dimensional Reference Only

MOTOR

Brushless DC, polarity protected, locked rotor protected (current limited), auto restart

INSULATION RESISTANCE

Min. 10 M Ohms at 500VDC

LIFE EXPECTANCY (L10)

Ball Bearing 60,000 Hours

Operating Temperature

-10C ~ +70C

Safety Approvals

UL/CUL, TUV, CE