



Agilent U1253B True RMS OLED Multimeter

User's and Service Guide



Agilent Technologies

Notices

© Agilent Technologies, Inc. , 2009

No part of this manual may be reproduced in any form or by any means (including electronic storage and retrieval or translation into a foreign language) without prior agreement and written consent from Agilent Technologies, Inc. as governed by United States and international copyright laws.

Manual Part Number

U1253-90035

Edition

First Edition, December 1, 2009

Agilent Technologies, Inc.
5301 Stevens Creek Blvd.
Santa Clara, CA 95051 USA

Trademark Acknowledgements

Pentium is a U.S. registered trademark of Intel Corporation.

Microsoft, Visual Studio, Windows, and MS Windows are trademarks of Microsoft Corporation in the United States and/or other countries.

Accessories Warranty

Agilent offers warranty for product's accessories for up to 3 months from the end-user acceptance date.

Standard Calibration Service (optional)

Agilent offers an optional calibration service contract for a period of 3 years from end-user acceptance date.

Warranty

The material contained in this document is provided “as is,” and is subject to being changed, without notice, in future editions. Further, to the maximum extent permitted by applicable law, Agilent disclaims all warranties, either express or implied, with regard to this manual and any information contained herein, including but not limited to the implied warranties of merchantability and fitness for a particular purpose. Agilent shall not be liable for errors or for incidental or consequential damages in connection with the furnishing, use, or performance of this document or of any information contained herein. Should Agilent and the user have a separate written agreement with warranty terms covering the material in this document that conflict with these terms, the warranty terms in the separate agreement shall control.

Technology Licenses

The hardware and/or software described in this document are furnished under a license and may be used or copied only in accordance with the terms of such license.

Restricted Rights Legend

U.S. Government Restricted Rights. Software and technical data rights granted to the federal government include only those rights customarily provided to end user customers. Agilent provides this customary commercial license in Software and technical data pursuant to FAR 12.211 (Technical Data) and 12.212 (Computer Software) and, for the Department of Defense, DFARS 252.227-7015 (Technical Data - Commercial Items) and DFARS 227.7202-3 (Rights in Commercial Computer Software or Computer Software Documentation).

Safety Notices

CAUTION

















A **CAUTION** notice denotes a hazard. It calls attention to an operating procedure, practice, or the like that, if not correctly performed or adhered to, could result in damage to the product or loss of important data. Do not proceed beyond a **CAUTION** notice until the indicated conditions are fully understood and met.

WARNING

A **WARNING** notice denotes a hazard. It calls attention to an operating procedure, practice, or the like that, if not correctly performed or adhered to, could result in personal injury or death. Do not proceed beyond a **WARNING** notice until the indicated conditions are fully understood and met.

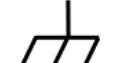
Safety Symbols

The following symbols on the instrument and in the documentation indicate precautions which must be taken to maintain safe operation of the instrument.

	Direct current (DC)		Off (supply)
	Alternating current (AC)		On (supply)
	Both direct and alternating current		Caution, risk of electric shock
	Three-phase alternating current		Caution, risk of danger (refer to this manual for specific Warning or Caution information)
	Earth (ground) terminal		Caution, hot surface
	Protective conductor terminal		Out position of a bi-stable push control
	Frame or chassis terminal		In position of a bi-stable push control
	Equipotentiality	CAT III 1000 V	Category III 1000 V overvoltage protection
	Equipment protected throughout by double insulation or reinforced insulation	CAT IV 600 V	Category IV 600 V overvoltage protection

General Safety Information

The following general safety precautions must be observed during all phases of operation, service, and repair of this instrument. Failure to comply with these precautions or with specific warnings elsewhere in this manual violates safety standards of design, manufacture, and intended use of the instrument. Agilent Technologies assumes no liability for the customer's failure to comply with these requirements.

WARNING

- When working above 60 V DC, 30 V AC rms, or 42.4 V AC peak, exercise caution – such range poses a shock hazard.
 - Do not measure more than the rated voltage (as marked on the multimeter) between terminals, or between terminal and earth ground.
 - Double-check the meters operation by measuring a known voltage.
 - For current measurement, turn off circuit power before connecting the multimeter to the circuit. Always place the multimeter in series with the circuit.
 - When connecting probes, always connect the common test probe first. When disconnecting probes, always disconnect the live test probe first.
 - Detach test probes from the multimeter before you open the battery cover.
 - Do not use the multimeter with the battery cover or part of the cover removed or loose.
 - Replace the battery as soon as the low battery indicator flashes on screen. This is to avoid false readings, which may lead to possible electric shock or personal injury.
 - Do not operate the product in an explosive atmosphere or in the presence of flammable gases or fumes.
 - Inspect the case for cracks or missing plastic. Pay extra attention to the insulation surrounding the connectors. Do not use the multimeter if it is damaged.
 - Inspect the test probes for damaged insulation or exposed metal, and check for continuity. Do not use the test probe if it is damaged.
 - Do not use any other AC charger adapter apart from the one certified by Agilent with this product.
 - Do not use repaired fuses or short-circuited fuse-holders. For continued protection against fire, replace the line fuses only with fuses of the same voltage and current rating and recommended type.
 - Do not service or perform adjustments alone. Under certain condition, hazardous voltages may exist, even with the equipment switched off. To avoid dangerous electric shock, service personnel must not attempt internal service or adjustment unless another person, capable of rendering resuscitation or first aid, is present.
 - Do not substitute parts or modify equipment to avoid the danger of introducing additional hazards. Return the product to the nearest Agilent Technologies Sales and Service office for service and repair to ensure the safety features are maintained.
 - Do not operate damaged equipment as the safety protection features built into this product may have been impaired, either through physical damage, excessive moisture, or any other reason. Remove power and do not use the product until safe operation can be verified by service-trained personnel. If necessary, return the product to the nearest Agilent Technologies Sales and Service office for service and repair to ensure the safety features are maintained.
-

CAUTION

- Turn off circuit power and discharge all high-voltage capacitors in the circuit before you perform resistance and capacitance measurements or continuity and diodes tests.
 - Use the correct terminals, function, and range for your measurements.
 - Never measure voltage when current measurement is selected.
 - Use only the recommended rechargeable battery. Ensure proper insertion of battery in the multimeter, and follow the correct polarity.
 - Disconnect test leads from all the terminals during battery charging.
-

Environmental Conditions

This instrument is designed for indoor use and in areas with low condensation. The table below shows the general environmental requirements for this instrument.





Environmental conditions	Requirements
Operating temperature	Full accuracy from $-20\text{ }^{\circ}\text{C}$ to $55\text{ }^{\circ}\text{C}$
Operating humidity	Full accuracy up to 80% R.H. (relative humidity) for temperature up to $35\text{ }^{\circ}\text{C}$, decreasing linearly to 50% R.H. at $55\text{ }^{\circ}\text{C}$
Storage temperature	$-40\text{ }^{\circ}\text{C}$ to $70\text{ }^{\circ}\text{C}$ (with battery removed)
Altitude	Up to 2000 m
Pollution degree	Pollution Degree 2

CAUTION

The U1253B True RMS OLED Multimeter complies with the following safety and EMC requirements.

- IEC 61010-1:2001/EN61010-1:2001 (2nd Edition)
- Canada: CAN/CSA-C22.2 No. 61010-1-04
- USA: ANSI/UL 61010-1:2004
- IEC61326-1:2005 / EN61326-1:2006
- Canada: ICES/NMB-001:2004
- Australia/New Zealand: AS/NZS CISPR11:2004

Regulatory Markings

 <p>ISM 1-A</p>	<p>The CE mark is a registered trademark of the European Community. This CE mark shows that the product complies with all the relevant European Legal Directives.</p>	 <p>N10149</p>	<p>The C-tick mark is a registered trademark of the Spectrum Management Agency of Australia. This signifies compliance with the Australia EMC Framework regulations under the terms of the Radio Communication Act of 1992.</p>
<p>ICES/NMB-001</p>	<p>ICES/NMB-001 indicates that this ISM device complies with the Canadian ICES-001. Cet appareil ISM est conforme a la norme NMB-001 du Canada.</p>		<p>This instrument complies with the WEEE Directive (2002/96/EC) marking requirement. This affixed product label indicates that you must not discard this electrical/electronic product in domestic household waste.</p>
 <p>C US</p>	<p>The CSA mark is a registered trademark of the Canadian Standards Association.</p>		

Waste Electrical and Electronic Equipment (WEEE) Directive 2002/96/EC

This instrument complies with the WEEE Directive (2002/96/EC) marking requirement. This affixed product label indicates that you must not discard this electrical/electronic product in domestic household waste.

Product Category:

With reference to the equipment types in the WEEE directive Annex 1, this instrument is classified as a "Monitoring and Control Instrument" product.

The affixed product label is as shown below.



Do not dispose in domestic household waste

To return this unwanted instrument, contact your nearest Agilent Technologies, or visit:

www.agilent.com/environment/product

for more information.

In This Guide...

1 Getting Started Tutorial

This chapter contains a brief description of the U1253B true RMS OLED multimeter front panel, rotary switch, keypad, display, terminals, and rear panel.

2 Making Measurements

This chapter contains detailed information on how to take measurements using the U1253B true RMS OLED multimeter.

3 Functions and Features

This chapter contains detailed information on functions and features available in the U1253B true RMS OLED multimeter.

4 Changing the Default Settings

This chapter describes how to change the default factory settings of the U1253B true RMS OLED multimeter and other available setting options.

5 Maintenance

This chapter will help you troubleshoot a malfunctioning U1253B true RMS OLED multimeter.

6 Performance Tests and Calibration

This chapter contains the performance test procedures and adjustment procedures. The performance test procedures allow you to verify that the U1253B true RMS OLED multimeter is operating within its published specifications. If these performance tests reveal any measurement function to be out of specification, you may calibrate the said function by following the relevant adjustment procedures.

7 Specifications

This chapter details the specifications of the U1253B true RMS OLED multimeter.

Declaration of Conformity (DoC)

The Declaration of Conformity (DoC) for this instrument is available on the Web site. You can search the DoC by its product model or description.

<http://regulations.corporate.agilent.com/DoC/search.htm>

NOTE

If you are unable to search for the respective DoC, please contact your local Agilent representative.

Contents

1 Getting Started Tutorial

Introducing the Agilent U1253B True RMS OLED Multimeter	2
Adjusting the tilt-stand	3
The front panel at a glance	6
The rotary switch at a glance	7
The keypad at a glance	8
The display at a glance	11
Selecting display with the Shift button	17
Selecting display with the Dual button	19
Selecting display with the Hz button	22
The terminals at a glance	25
The rear panel at a glance	27

2 Making Measurements

Measuring Voltage	30
Measuring AC voltage	30
Measuring DC voltage	32
Measuring Current	33
μ A and mA measurement	33
Percentage scale of 4 mA to 20 mA	35
A (ampere) measurement	37
Frequency Counter	38
Measuring Resistance, Conductance, and Testing Continuity	40
Testing Diodes	47
Measuring Capacitance	50
Measuring Temperature	51

Alerts and Warning During Measurement	54
Voltage alert	54
Input warning	55
Charge terminal alert	56

3 Functions and Features

Dynamic Recording	58
Data Hold (Trigger Hold)	60
Refresh Hold	62
Null (Relative)	64
Decibel Display	66
1 ms Peak Hold	69
Data Logging	71
Manual logging	71
Interval logging	73
Reviewing logged data	75
Square wave Output	77
Remote Communication	81

4 Changing the Default Settings

Selecting Setup Mode	84
Default Factory Settings and Available Setting Options	85
Setting Data Hold/Refresh Hold mode	89
Setting data logging mode	90
Setting dB measurement	92
Setting reference impedance for dBm measurement	93
Setting thermocouple types	94
Setting temperature unit	94
Setting percentage scale readout	96

Sound setting for continuity test	97
Setting minimum measurable frequency	98
Setting beep frequency	99
Setting Auto Power Off mode	100
Setting power-on backlight brightness level	102
Setting the power-on melody	103
Setting the power-on greeting screen	104
Setting baud rate	105
Setting parity check	106
Setting data bits	107
Setting echo mode	108
Setting print mode	109
Revision	110
Serial number	110
Voltage alert	111
M-initial	112
Smooth refresh rate	116
Returning to default factory settings	117
Setting the battery type	118
Setting the DC filter	119

5 Maintenance

Introduction	122
General maintenance	122
Battery replacement	123
Charging battery	125
Fuse replacement	132
Troubleshooting	134

6 Performance Tests and Calibration

Calibration Overview	136
Closed-case electronic calibration	136

Agilent Technologies' calibration services	136
Calibration interval	136
Other recommendations for calibration	137
Recommended Test Equipment	138
Basic Operating Tests	139
Testing the display	139
Current terminals test	140
Charge terminals alert test	141
Test Considerations	142
Input Connections	143
Performance Verification Tests	144
Calibration Security	151
Unsecuring the instrument for calibration	151
Changing Calibration Security Code	154
Resetting the security code to factory default	156
Adjustment Considerations	158
Valid adjustment reference input values	159
Calibration from Front Panel	163
Calibration process	163
Calibration procedures	164
Calibration count	171
Calibration error codes	172

7 Specifications

DC Specifications	174
AC Specifications	177
AC+DC Specifications	179
Temperature and Capacitance Specifications	181
Temperature specifications	181

Capacitance specifications	182
Frequency Specifications	183
Frequency sensitivity during voltage measurement	183
Frequency sensitivity during current measurement	184
Duty cycle ^[1] and pulse width ^[2]	185
Frequency counter specifications	186
Peak hold (capturing changes)	187
Square wave output	187
Operating Specifications	188
General Specifications	191
Measurement Category	193
Measurement category definition	193

List of Figures

Figure 1-1	Tilt-stand at 60°	3
Figure 1-2	Tilt-stand at 30°	4
Figure 1-3	Tilt-stand at hanging position	5
Figure 1-4	U1253B keypad	8
Figure 1-5	Connector terminals	25
Figure 1-6	Rear panel of U1253B	27
Figure 2-1	Measuring AC voltage	31
Figure 2-2	Measuring DC voltage	32
Figure 2-3	Measuring μA and mA current	34
Figure 2-4	Measurement scale of 4 mA to 20 mA	36
Figure 2-5	A (ampere) current measurement	37
Figure 2-6	Measuring frequency	39
Figure 2-7	Type of display when Smart Ω is enabled	41
Figure 2-8	Measuring resistance	42
Figure 2-9	Resistance, audible continuity, and conductance tests	43
Figure 2-10	Short continuity and open continuity test	45
Figure 2-11	Conductance measurement	46
Figure 2-12	Measuring the forward bias of a diode	48
Figure 2-13	Measuring the reverse bias of a diode	49
Figure 2-14	Surface temperature measurement	53
Figure 2-15	Input terminal warning	55
Figure 2-16	Charge terminal alert	56
Figure 3-1	Dynamic recording mode operation	59
Figure 3-2	Data hold mode operation	61
Figure 3-3	Refresh hold mode operation	63
Figure 3-4	Null (relative) mode operation	65
Figure 3-5	dBm display mode operation	67
Figure 3-6	dBV display mode operation	68
Figure 3-7	1 ms peak hold mode operation	70
Figure 3-8	Manual (hand) logging mode operation	72
Figure 3-9	Full log	72
Figure 3-10	Interval (time) logging mode operation	74
Figure 3-11	Log review mode operation	76
Figure 3-12	Frequency adjustment for square wave output	78
Figure 3-13	Duty cycle adjustment for square wave output	79

Figure 3-14	Pulse width adjustment for square wave output	80
Figure 3-15	Cable connection for remote communication	81
Figure 4-1	Setup menu screens	88
Figure 4-2	Data Hold/Refresh Hold setup	89
Figure 4-3	Data logging setup	90
Figure 4-4	Log time setup for interval (time) logging	91
Figure 4-5	Decibel measurement setup	92
Figure 4-6	Setting up the reference impedance for dBm unit	93
Figure 4-7	Thermocouple type setup	94
Figure 4-8	Temperature unit setup	95
Figure 4-9	Setting up percentage scale readout	96
Figure 4-10	Choosing the sound used in continuity test	97
Figure 4-11	Minimum frequency setup	98
Figure 4-12	Beep frequency setup	99
Figure 4-13	Automatic power saving setup	101
Figure 4-14	Power-on backlight setup	102
Figure 4-15	Power-on melody setup	103
Figure 4-16	Power-on greeting setup	104
Figure 4-17	Baud rate setup for remote control	105
Figure 4-18	Parity check setup for remote control	106
Figure 4-19	Data bits setup for remote control	107
Figure 4-20	Echo mode setup for remote control	108
Figure 4-21	Print mode setup for remote control	109
Figure 4-22	Revision number	110
Figure 4-23	Serial number	110
Figure 4-24	Voltage alert setup	111
Figure 4-25	Setting initial measurement functions	113
Figure 4-26	Navigating between the initial functions pages	114
Figure 4-27	Editing initial measurement function/range	114
Figure 4-28	Editing initial measurement function/range and initial output values	115
Figure 4-29	Refresh rate for primary display readings	116
Figure 4-30	Resetting to default factory settings	117
Figure 4-31	Battery type selection	118
Figure 4-32	DC filter	119
Figure 5-1	Rear panel of the Agilent U1253B True RMS OLED Multimeter	124
Figure 5-2	Self-testing time display	126

Figure 5-3	Performing self-test	127
Figure 5-4	Charging mode	129
Figure 5-5	Fully charged and in the trickle state	129
Figure 5-6	Battery charging procedures	131
Figure 5-7	Fuse replacement	133
Figure 6-1	Displaying all OLED pixels	139
Figure 6-2	Current terminal error message	140
Figure 6-3	Charge terminal error message	141
Figure 6-4	Unsecuring the instrument for calibration	153
Figure 6-5	Changing the calibration security code	155
Figure 6-6	Resetting security code to factory default	157
Figure 6-7	Typical calibration process flow	166

List of Tables

Table 1-1	Rotary switch description and functions	7
Table 1-2	Keypad descriptions and functions	9
Table 1-3	General display annunciators	11
Table 1-4	Primary display annunciators	12
Table 1-5	Secondary display annunciators	14
Table 1-6	Analog bar range and counts	16
Table 1-7	Selecting display with the Shift button	17
Table 1-8	Selecting display with the Dual button	19
Table 1-9	Selecting display with the Hz button	22
Table 1-10	Terminal connections for different measurement functions	26
Table 2-1	Percentage scale and measurement range	35
Table 2-2	Audible continuity measurement range	44
Table 3-1	Available frequencies for square wave output	77
Table 4-1	Default factory settings and available setting options for each feature	85
Table 4-2	Available settings for M-initial	112
Table 5-1	Battery voltage and corresponding percentage of charges in standby and charging modes	126
Table 5-2	Error messages	128
Table 5-3	Fuse specifications	132
Table 5-4	Basic troubleshooting procedures	134
Table 6-1	Recommended test equipment	138
Table 6-2	Performance verification tests	145
Table 6-3	Valid adjustment reference input values	159
Table 6-4	List of calibration items	167
Table 6-5	Calibration error codes and their respective meanings	172
Table 7-1	DC accuracy \pm (% of reading + number of LSD)	174
Table 7-2	Accuracy specifications \pm (% of reading + number of LSD) for true RMS AC voltage	177
Table 7-3	Accuracy specifications \pm (% of reading + number of LSD) for true RMS AC current	177
Table 7-4	Accuracy specifications \pm (% of reading + number of LSD) for AC+DC voltage	179
Table 7-5	Accuracy specifications \pm (% of reading + number of	

	LSD) for AC+DC current	179
Table 7-6	Temperature specifications	181
Table 7-7	Capacitance specifications	182
Table 7-8	Frequency specifications	183
Table 7-9	Frequency sensitivity and trigger level	183
Table 7-10	Sensitivity for current measurement	184
Table 7-11	Accuracy for duty cycle	185
Table 7-12	Accuracy for pulse width	185
Table 7-13	Frequency counter (divide 1) specifications	186
Table 7-14	Frequency counter (divide 100) specifications	186
Table 7-15	Peak hold specification	187
Table 7-16	Square wave output specifications	187
Table 7-17	Measurement rate	188
Table 7-18	Input Impedance	189

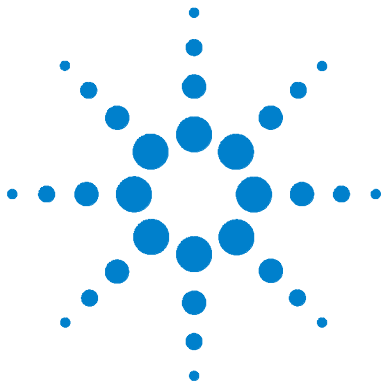

1 Getting Started Tutorial

Introducing the Agilent U1253B True RMS OLED Multimeter	2
Adjusting the tilt-stand	3
The front panel at a glance	6
The rotary switch at a glance	7
The keypad at a glance	8
The display at a glance	11
Selecting display with the Shift button	17
Selecting display with the Dual button	19
Selecting display with the Hz button	22
The terminals at a glance	25
The rear panel at a glance	27

This chapter contains a brief description of the U1253B true RMS OLED multimeter front panel, rotary switch, keypad, display, terminals, and rear panel.



Introducing the Agilent U1253B True RMS OLED Multimeter

The key features of the true RMS OLED multimeter are:

- DC, AC, and AC+DC voltage and current measurements.
- True RMS measurement for both AC voltage and current.
- Rechargeable Ni-MH battery with built-in charging capability.
- Ambient temperature readout that accompanies most measurement readouts (both in single and dual display modes).
- Battery capacity indicator.
- Bright orange OLED (Organic Light Emitting Diode) display.
- Resistance measurement up to 500 M Ω .
- Conductance measurement from 0.01 nS (100 G Ω) to 500 nS.
- Capacitance measurement up to 100 mF.
- Frequency counter up to 20 MHz.
- Percentage scale readout for 4 mA to 20 mA, or 0 mA to 20 mA measurement.
- Measurement of dBm with selectable reference impedance.
- 1 ms peak hold to catch in-rush voltage and current easily.
- Temperature test with selectable 0 °C compensation (without ambient temperature compensation).
- J-type or K-type probe for temperature measurement.
- Frequency, duty cycle, and pulse width measurements.
- Dynamic recording for minimum, maximum, average, and present readings.
- Data hold with manual or auto trigger and relative modes.
- Diode and audible continuity tests.
- Square wave generator with selectable frequency, pulse width, and duty cycle.

- Agilent GUI Application Software (the IR-USB cable is sold separately).
- Closed case calibration.
- 50,000-count precision true RMS digital multimeter, designed to meet EN/IEC 61010-1:2001 Category III 1000 V/ Category IV 600 V, Pollution Degree 2 standards.

Adjusting the tilt-stand

To adjust the multimeter to a 60° standing position, pull the tilt-stand outward to its maximum reach.

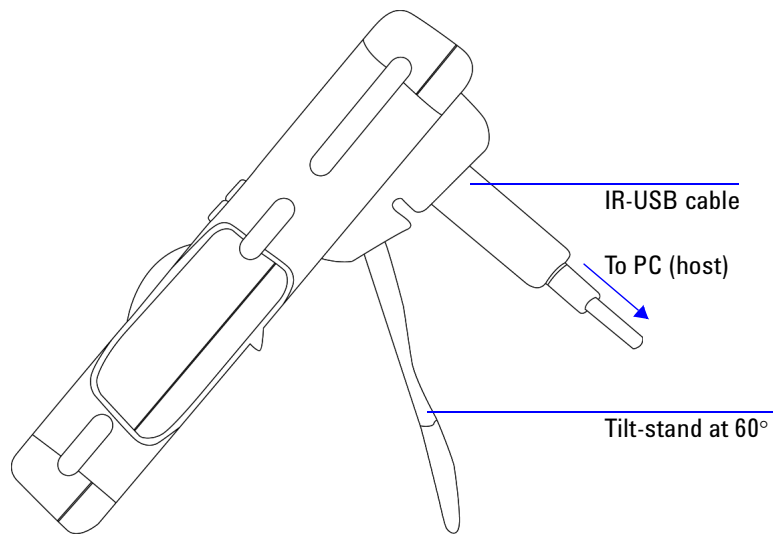

Figure 1-1 Tilt-stand at 60°

To adjust the multimeter to a 30° standing position, bend the tip of the stand so that it is parallel to ground, then pull the stand outward to its maximum reach.

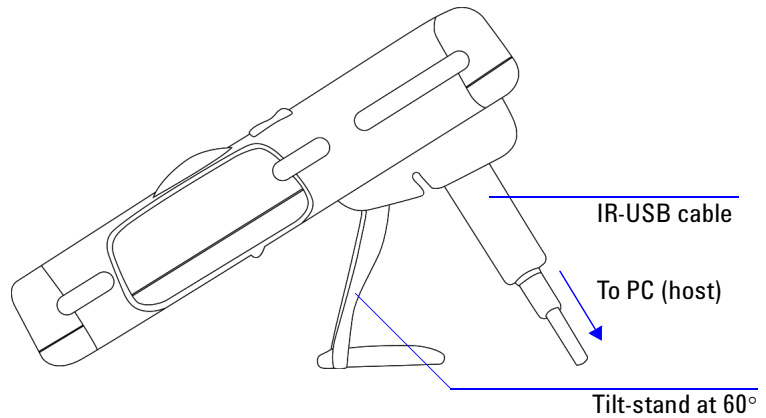

Figure 1-2 Tilt-stand at 30°

To adjust the multimeter to a hanging position, flip the stand upward and over its maximum reach until it is detached from its hinge. Then flip the stand over so that its inner surface is facing the rear. Now, press the stand down into its hinge. Follow the step-by-step pictorial instructions below.



Figure 1-3 Tilt-stand at hanging position

The front panel at a glance

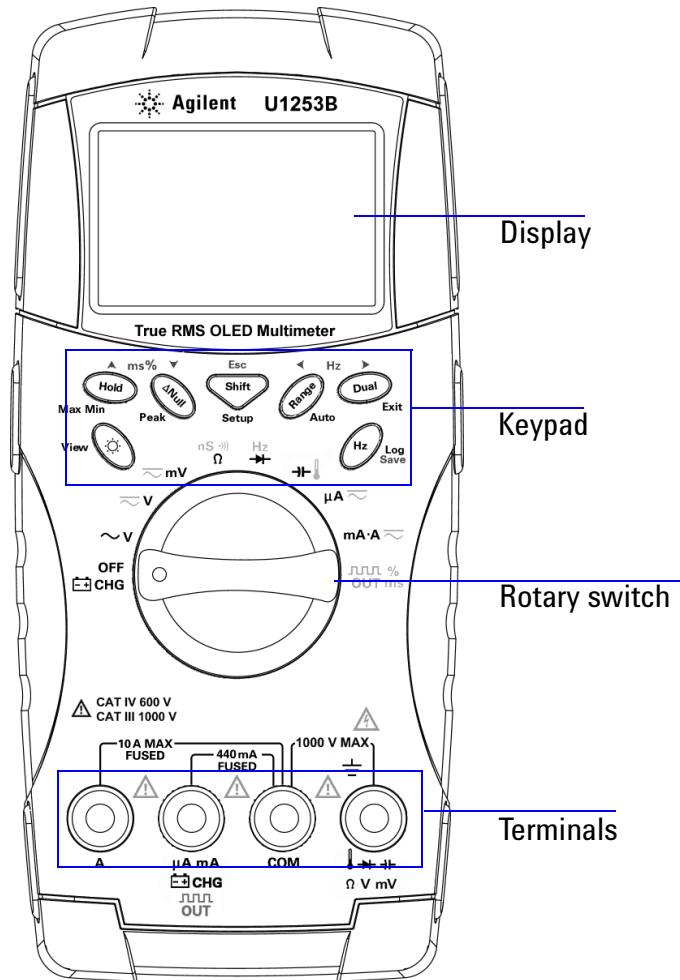

The rotary switch at a glance

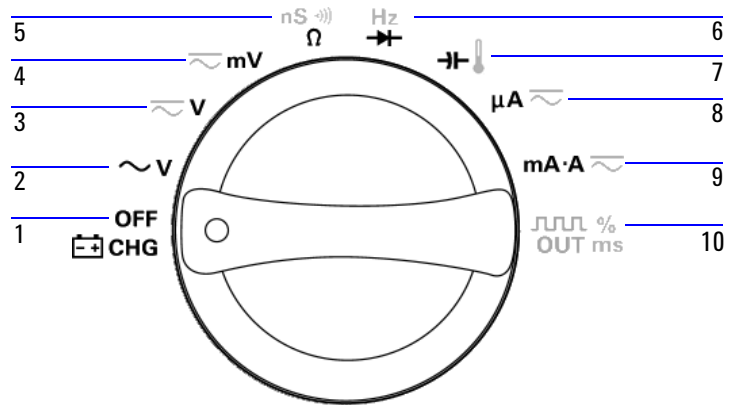

Table 1-1 Rotary switch description and functions

	Description/Function
1	Charge mode or OFF
2	AC V
3	DC V, AC V, or AC+DC V
4	DC mV, AC mV, or AC+DC mV
5	Resistance (Ω), continuity, or conductance (nS)
6	Frequency counter or diode
7	Capacitance or temperature
8	DC μ A, AC μ A, or AC+DC μ A
9	DC mA, DC A, AC mA, AC A, AC+DC mA, or AC+DC A
10	Square wave output, duty cycle, or pulse width output

The keypad at a glance

The operation of each key is explained in [Table 1-2](#) below. Pressing a key displays a related symbol and emits a sound on the beeper. Turning the rotary switch to another position resets the current operation of the key. [Figure 1-4](#) shows the keypad of the U1253B.

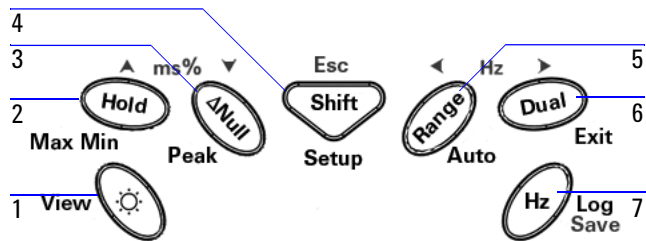

























































Figure 1-4 U1253B keypad

Table 1-2 Keypad descriptions and functions





	Function when pressed for less than 1 second	Function when pressed for more than 1 second
1	 cycles through OLED display brightness levels.	<ul style="list-style-type: none">  enters Log Review mode. Press  to switch between manual or interval logging data. Press  or  to view first or last logged data respectively. Press  or  to scroll through the logged data. Press  for more than 1 second to exit this mode.
2	<ul style="list-style-type: none">  holds the current measured value. In Data Hold mode () , press  again to trigger the holding of the next measured value. Press  for more than 1 second to exit this mode. In Refresh Hold mode () , the reading is updated automatically once the reading is stable and the count setting is exceeded^[1]. Press  again to exit this mode. 	<ul style="list-style-type: none">  enters the Dynamic Recording mode. Press  again to scroll through maximum, minimum, average, or present readings (indicated by , , , or  on the display). Press  for more than 1 second to exit this mode.
3	<ul style="list-style-type: none">  saves the displayed value as a reference to be subtracted from subsequent measurements. While in null mode, press  to view the relative value (0BASE) that has been saved. The saved relative value will be displayed for 3 seconds. Press  while the relative value (0BASE) is being displayed to cancel the Null function. 	<ul style="list-style-type: none">  enters the 1 ms Peak Hold mode. Press  to scroll through maximum () and minimum () peak readings. Press  for more than 1 second to exit this mode.
4	 scrolls through the measurement function(s) of the present rotary switch selection.	<ul style="list-style-type: none">  enters the Setup mode. In the Setup mode, press  or  to navigate through the menu pages. Press  or  to scroll through the available settings. Press  to edit the specified value. Press  again to save the new settings and exit the editing mode, or press  to exit without saving. Press  for more than 1 second to exit this mode.
5	 scrolls through the available measurement ranges (except when the rotary switch is at the  or  position) ^[2] .	 enters the Auto Range mode.





1 Getting Started Tutorial

Table 1-2 Keypad descriptions and functions (continued)

	Function when pressed for less than 1 second	Function when pressed for more than 1 second
6	 scrolls through the available dual-combination displays (except when the rotary switch is at the  or  $\frac{FULL}{OUT} \%$ position, or when the multimeter is in 1 ms Peak Hold or Dynamic Recording mode) ^[3] .	 exits Hold, Null, Dynamic Recording, 1 ms Peak Hold, and dual display modes.
7	 <ul style="list-style-type: none"> enters the Frequency Test mode for current or voltage measurements. Press  to scroll through frequency (Hz), pulse width (ms), and duty cycle (%) functions. In duty cycle (%) and pulse width (ms) tests, press  to switch between positive and negative edge trigger. When the rotary switch is at the  position, and the Frequency Counter function is selected, pressing  will cycle through the frequency, pulse width, and duty cycle measurements. 	<ul style="list-style-type: none"> If data logging is set as HAND (manual data logging), pressing  for more than 1 second will log the present reading into the memory. The display will return to normal after 3 seconds. To manually log another reading, press  again for more than 1 second. If data logging is set as TIME (automatic data logging), pressing  for more than 1 second will enter the automatic data logging mode, and data is logged at the interval defined in Setup mode^[1]. Press  for more than 1 second to exit data logging mode.

^[1] See [Table 4-1](#) on page 85 for details of available options.











^[2] When the rotary switch is at  and the temperature measurement function is selected, pressing  will not affect any setting. When the rotary switch is at  and the frequency counter function is selected, press  to switch between dividing the signal frequency by 1 or 100.

^[3] When the rotary switch is at  and the temperature measurement function is selected, ETC (Environment Temperature Compensation) is ON by default. Press  to disable ETC;  will appear on the display. For pulse width and duty cycle measurements, press  to switch between positive and negative edge trigger. When the multimeter is in Peak or Dynamic Recording mode, press  to restart the 1 ms Peak Hold or Dynamic Recording mode.

The display at a glance









The display annunciators are described in the following pages.

Table 1-3 General display annunciators

OLED Annunciator	Description
	Remote control
K, J	Type of thermocouple: K (K-type); J (J-type)
ΔNULL	Null math function
O'BASE	Relative value for Null mode
	Diode
	Audible continuity:  (SINGLE) or  (TONE) depending on Setup configuration
	View mode for checking logged data
	Data logging indication
A: 1000, H: 100, A: Full, A: Void	Index for logging data
	<ul style="list-style-type: none"> • Positive slope for pulse width (ms) and duty cycle (%) measurements • Capacitor is charging (during capacitance measurement)
	<ul style="list-style-type: none"> • Negative slope for pulse width (ms) and duty cycle (%) measurements • Capacitor is discharging (during capacitance measurement)
	Low battery indication (alternating between these two symbols)
	Auto Power-Off enabled
R-HOLD	Refresh (auto) Hold

1 Getting Started Tutorial

Table 1-3 General display annunciators

OLED Annunciator	Description
T- 	Trigger (manual) Hold
	Dynamic Recording mode: Present value on primary display
	Dynamic Recording mode: Maximum value on primary display
	Dynamic Recording mode: Minimum value on primary display
	Dynamic Recording mode: Average value on primary display
P- 	1 ms Peak Hold mode: Positive peak value on primary display
P- 	1 ms Peak Hold mode: Negative peak value on primary display
	Hazardous Voltage annunciator for measuring voltage ≥ 30 V or Overload

The primary display annunciators are described below.

Table 1-4 Primary display annunciators







OLED Annunciator	Description
AUTO	Auto range
	AC+DC
	DC
	AC
	Polarity, digits, and decimal points for primary display

Table 1-4 Primary display annunciators

OLED Annunciator	Description
dBm	Decibel unit relative to 1 mW
dBV	Decibel unit relative to 1 V
Hz, kHz, MHz	Frequency units: Hz, kHz, MHz
Ω , k Ω , M Ω	Resistance units: Ω , k Ω , M Ω
nS	Conductance unit: nS
mV, V	Voltage units: mV, V
μ A, mA, A	Current units: μ A, mA, A
nF, μ F, mF	Capacitance units: nF, μ F, mF
$^{\circ}$ C	Celsius temperature unit
$^{\circ}$ F	Fahrenheit temperature unit
%	Duty cycle measurement
ms	Pulse width unit
% 0-20	Percentage scale readout based on DC 0 mA to 20 mA
% 4-20	Percentage scale readout based on DC 4 mA to 20 mA

1 Getting Started Tutorial

Table 1-4 Primary display annunciators

OLED Annunciator	Description
	Reference impedance for the dBm unit
	Scale of bar graph

The secondary display annunciators are described below.

Table 1-5 Secondary display annunciators















OLED Annunciator	Description
	AC+DC
	DC
	AC
	Polarity, digits, and decimal points for secondary display
	Decibel unit relative to 1 mW
	Decibel unit relative to 1 V
	Frequency units: Hz, kHz, MHz
	Resistance units: Ω , k Ω , M Ω
	Voltage units: mV, V
	Current units: μ A, mA, A
	Conductance unit: nS
	Capacitance units: nF, μ F, mF

Table 1-5 Secondary display annunciators

OLED Annunciator	Description
°C	Celsius ambient temperature unit
°F	Fahrenheit ambient temperature unit
DCB	No ambient temperature compensation; just thermocouple measurement
MS	Pulse width unit
B:AS	Bias display
LEAK	Leak display
0000S	Elapsed time unit: s (second) for Dynamic Recording and 1 ms Peak Hold modes
⚡	Hazardous Voltage annunciator for measuring voltage ≥ 30 V or Overload

The analog bar emulates the needle on an analog multimeter, without displaying the overshoot. When measuring peak or null adjustments and viewing fast-changing inputs, the bar graph provides a useful indication because it has a faster updating rate to cater for fast-response applications.

For frequency, duty cycle, pulse width, 4 mA to 20 mA % scale, 0 mA to 20 mA % scale, dBm, dBV, and temperature measurements, the bar graph does not represent the primary display value.

- For example, when frequency, duty cycle, or pulse width is displayed on the primary display during voltage or current measurement, the bar graph represents the voltage or current value (not the frequency, duty cycle, or pulse width).
- Another example is when 4 mA to 20 mA % scale () or 0 mA to 20 mA % scale () is displayed on the primary display, the bar graph represents the current value and not the percentage value.

1 Getting Started Tutorial

The “+” or “-” sign indicates whether the measured or calculated value is positive or negative. Each segment represents 2000 or 400 counts depending on the range indicated on the peak bar graph. See the following table.









Table 1-6 Analog bar range and counts

Range	Counts/segments	Used for the function
0 1 2 3 4 5V +-----+ AUTO	2000	V, A, Ω , nS, Diode
0 2 4 6 8 1000V +-----+ AUTO	400	V, A, Capacitance

Selecting display with the Shift button



The table below shows the primary display selection, with respect to measurement function (rotary switch position), using the Shift button.

Table 1-7 Selecting display with the Shift button

Rotary switch position (Function)	Primary display
 (AC voltage)	AC V
	dBm or dBV (in dual display mode) ^{[1] [2]}
 (AC+DC voltage)	DC V
	AC V
	AC+DC V
 (AC+DC voltage)	DC mV
	AC mV
	AC+DC mV
 (AC+DC voltage)	DC mV
	AC mV
	AC+DC mV
	Ω
	Ω (Audible)
	AC+DC mV
	Diode
	Hz
	Capacitance
	Temperature
 (AC+DC current)	DC μA
	AC μA
	AC+DC μA

1 Getting Started Tutorial



Table 1-7 Selecting display with the Shift button (continued)

Rotary switch position (Function)	Primary display
 (AC+DC current) (With the positive probe inserted into the $\mu\text{A}.\text{mA}$ terminal)	DC mA
	AC mA
	AC+DC mA
	% (0 mA to 20 mA or 4 mA to 20 mA ^[1]) (Reading in mA or A is shown as secondary display)
 (AC+DC current) (With the positive probe inserted into the A terminal)	DC A
	AC A
	AC+DC A
	Duty cycle (%)
	Pulse width (ms)

^[1] Depends on the relevant setting in the Setup mode.









^[2] Press  for more than 1 second to return to AC V measurement only.

Selecting display with the Dual button

- Press  to select different combinations of the dual display.
- Press and hold  for more than 1 second to return to normal single display.

See the following table.

Table 1-8 Selecting display with the Dual button

Rotary switch position (Function)	Primary display	Secondary display
 (AC voltage)	AC V	Hz (AC coupling)
	dBm or dBV ^[1]	AC V
 (Default is DC voltage)	DC V	Hz (DC coupling)
	dBm or dBV ^[1]	DC V
	DC V	AC V
 (Press  to select AC voltage)	AC V	Hz (AC coupling)
	dBm or dBV ^[1]	AC V
	AC V	DC V
 (Press  twice to select AC+DC voltage)	AC+DC V	Hz (AC coupling)
	dBm or dBV ^[1]	AC+DC V
	AC+DC V	AC V
	AC+DC V	DC V
 (Default is DC voltage)	DC mV	Hz (DC coupling)
	dBm or dBV ^[1]	DC mV
	DC mV	AC mV
 (Press  to select AC voltage)	AC mV	Hz (AC coupling)
	dBm or dBV ^[1]	AC mV
	AC mV	DC mV

1 Getting Started Tutorial

Table 1-8 Selecting display with the Dual button (continued)

















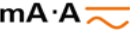
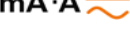

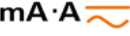
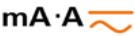

Rotary switch position (Function)	Primary display	Secondary display
 mV (Press  twice to select AC+DC voltage)	AC+DC mV	Hz (AC coupling)
	dBm or dBV ^[1]	AC+DC mV
	AC+DC mV	AC mV
	AC+DC mV	DC mV
 µA (Default is DC current)	DC µA	Hz (DC coupling)
	DC µA	AC µA
 µA (Press  to select AC current)	AC µA	Hz (AC coupling)
	AC µA	DC µA
 µA (Press  twice to select AC+DC current)	AC+DC µA	Hz (AC coupling)
	AC+DC µA	AC µA
	AC+DC µA	DC µA
 mA·A (Default is DC current)	DC mA	Hz (DC coupling)
	DC mA	AC mA
 mA·A (Press  to select AC current)	AC mA	Hz (AC coupling)
	AC mA	DC mA
 mA·A (Press  twice to select AC+DC current)	AC+DC mA	Hz (AC coupling)
	AC+DC mA	AC mA
	AC+DC mA	DC mA
 mA·A (Default is DC current)	DC A	Hz (DC coupling)
	DC A	AC A

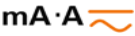
Table 1-8 Selecting display with the Dual button (continued)

Rotary switch position (Function)	Primary display	Secondary display
 (Press  to select AC current)	AC A	Hz (AC coupling)
	AC A	DC A
 (Press  twice to select AC+DC current)	AC+DC A	Hz (AC coupling)
	AC+DC A	AC A
	AC+DC A	DC A
 (Capacitance)/  (Diode)/  (Conductance)	nF / V / nS	No secondary display. Ambient temperature in °C or °F is displayed in upper-right corner.
 (Resistance)	Ω	DC mV Bias, DC A Leak Ambient temperature in °C or °F is displayed in upper-right corner.
 (Temperature)	°C (°F)	If °C/°F or °F/°C dual-display is selected in the Setup, then the secondary display will indicate the temperature in the other unit (as opposed to the primary display). If single-unit display is selected in the Setup, there will be no secondary display. Ambient temperature in °C or °F is displayed in upper-right corner. Select 0 °C compensation by pressing  .

[1] Depends the relevant setting in Setup mode.

Selecting display with the Hz button

The frequency measurement function is able to detect the presence of harmonic currents in neutral conductors and determine whether these neutral currents are the result of unbalanced phases or non-linear loads.



- Press  to enter the Frequency measurement mode for current or voltage measurements – voltage or current on the secondary display, and frequency on the primary display.
- Alternatively, pulse width (ms) or duty cycle (%) can be displayed on the primary display by pressing  again. This allows simultaneous monitoring of real-time voltage or current with frequency, duty cycle, or pulse width.
- Hold  for more than 1 second to resume voltage or current reading on the primary display.

Table 1-9 Selecting display with the Hz button





















Rotary switch position (Function)	Primary display	Secondary display
 V  V (For  V, press  to select AC voltage)	Frequency (Hz)	AC V
	Pulse width (ms)	
	Duty cycle (%)	
 V (Default is DC voltage)	Frequency (Hz)	DC V
	Pulse width (ms)	
	Duty cycle (%)	
 V (Press  twice to select AC+DC voltage)	Frequency (Hz)	AC+DC V
	Pulse width (ms)	
	Duty cycle (%)	
 mV (Default is DC voltage)	Frequency (Hz)	DC mV
	Pulse width (ms)	
	Duty cycle (%)	

Table 1-9 Selecting display with the Hz button (continued)

Rotary switch position (Function)	Primary display	Secondary display
 mV (Press  to select AC voltage)	Frequency (Hz)	AC mV
	Pulse width (ms)	
	Duty cycle (%)	
 mV (Press  twice to select AC+DC voltage)	Frequency (Hz)	AC+DC mV
	Pulse width (ms)	
	Duty cycle (%)	
 µA (Default is DC current)	Frequency (Hz)	DC µA
	Pulse width (ms)	
	Duty cycle (%)	
 µA (Press  to select AC current)	Frequency (Hz)	AC µA
	Pulse width (ms)	
	Duty cycle (%)	
 µA (Press  twice to select AC+DC current)	Frequency (Hz)	AC+DC µA
	Pulse width (ms)	
	Duty cycle (%)	
 mA·A (Default is DC current)	Frequency (Hz)	DC mA or A
	Pulse width (ms)	
	Duty cycle (%)	
 mA·A (Press  to select AC current)	Frequency (Hz)	AC mA or A
	Pulse width (ms)	
	Duty cycle (%)	
 mA·A (Press  twice to select AC+DC current)	Frequency (Hz)	AC+DC mA
	Pulse width (ms)	
	Duty cycle (%)	

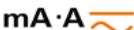
1 Getting Started Tutorial

Table 1-9 Selecting display with the Hz button (continued)

Rotary switch position (Function)	Primary display	Secondary display
Hz (Frequency counter) (Only applicable for Divide-1 input)	Frequency (Hz)	Pulse width (ms)
	Pulse width (ms)	Frequency (Hz)
	Duty cycle (%)	

The terminals at a glance

CAUTION

To avoid damaging this device, do not exceed the rated input limit.

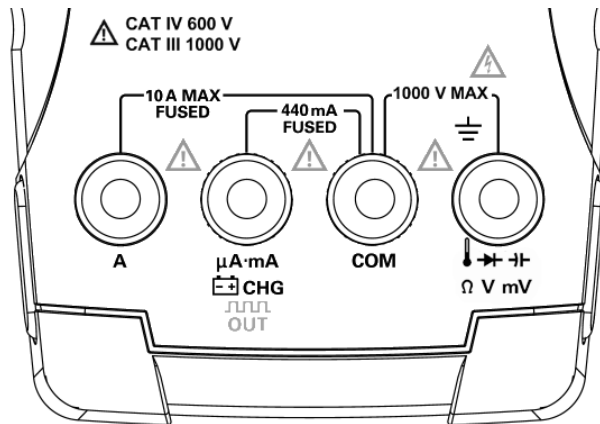













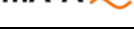

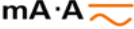







Figure 1-5 Connector terminals

1 Getting Started Tutorial

Table 1-10 Terminal connections for different measurement functions

Rotary switch position	Input terminals		Overload protection
 V	    ·mV	COM	1000 Vrms
 V			
 mV			
 nS  Ω			
 Hz 			
			
 μA   mA·A 	μA·mA	COM	440 mA/1000 V, 30 kA fast-acting fuse
 mA·A 	A	COM	11 A/1000V, 30kA fast-acting fuse
 % OUT ms	 OUT	COM	
OFF  CHG	 CHG	COM	440 mA/1000 V fast-acting fuse

The rear panel at a glance

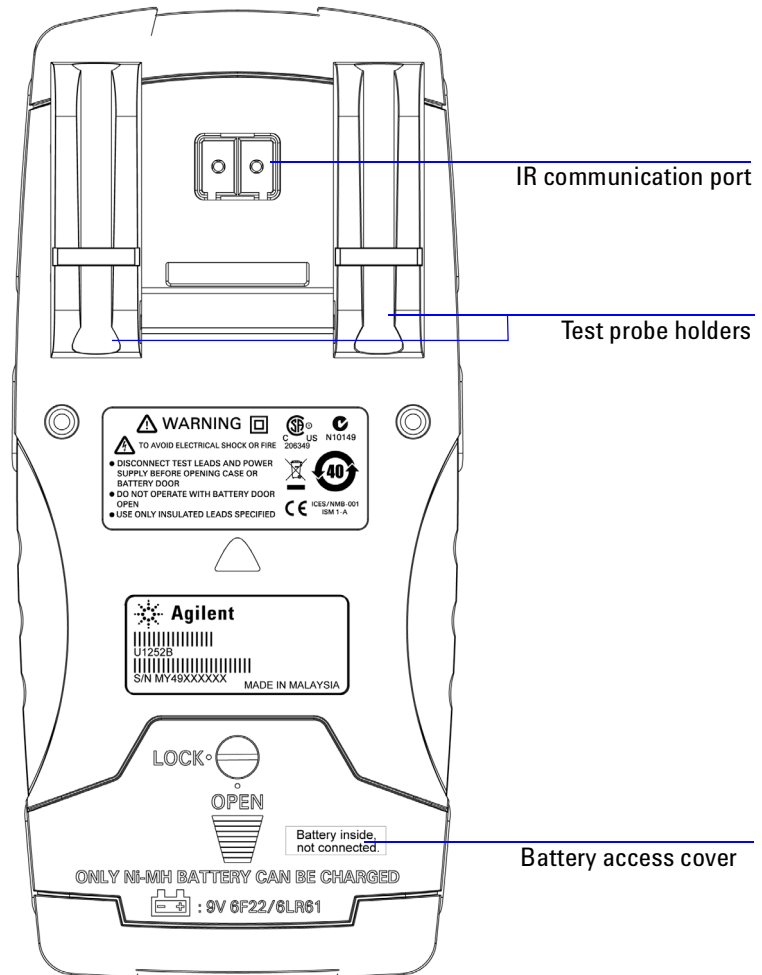
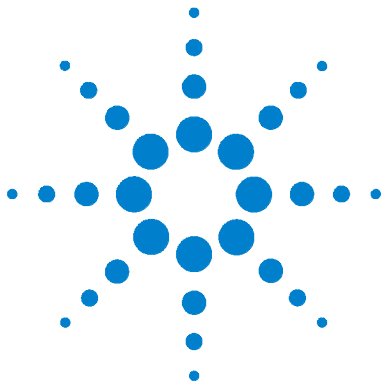

Figure 1-6 Rear panel of U1253B

1 Getting Started Tutorial



2 Making Measurements



Measuring Voltage	30
Measuring AC voltage	30
Measuring DC voltage	32
Measuring Current	33
mA and mA measurement	33
Percentage scale of 4 mA to 20 mA	35
A (ampere) measurement	37
Frequency Counter	38
Measuring Resistance, Conductance, and Testing Continuity	40
Testing Diodes	47
Measuring Capacitance	50
Measuring Temperature	51
Alerts and Warning During Measurement	54
Voltage alert	54
Input warning	55
Charge terminal alert	56

This chapter contains detailed information on how to take measurements using the U1253B true RMS OLED multimeter.



Measuring Voltage







The U1253B true RMS OLED multimeter returns an accurate RMS reading not only for sine waves, but also other AC signals such as square, triangle, and staircase waves.

For AC with DC offset, use AC+DC measurement by selecting  **V** or  **mV** with the rotary switch.

CAUTION

Ensure that terminal connections are correct for that particular measurement before making any measurement. To avoid damaging the device, do not exceed the rated input limit.

Measuring AC voltage

- 1 Set the rotary switch to  **V**,  **V**, or  **mV**.
- 2 Press  if necessary to ensure  is shown on the display.
- 3 Connect the red and black test leads to input terminals **V.mV (red)** and **COM (black)** respectively (refer to [Figure 2-1](#) on page 31).
- 4 Probe the test points and read the display.
- 5 Press  to display dual measurements. See [“Selecting display with the Dual button”](#) on page 19 for a list of dual measurements available. Press and hold  for more than 1 second to exit dual display mode.

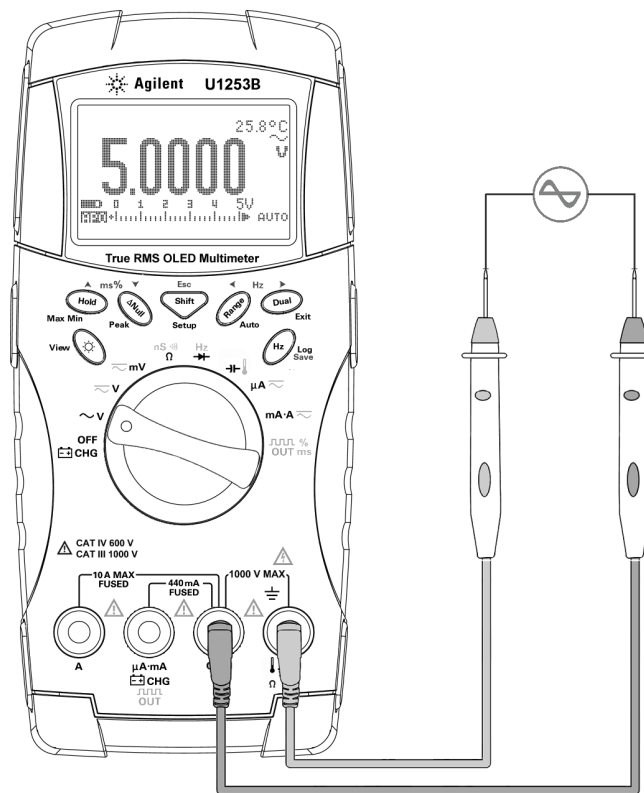

Figure 2-1 Measuring AC voltage

Measuring DC voltage

- 1 Set the rotary switch to \sim V or \sim mV.
- 2 Press **Shift** if necessary to ensure that ----- is shown on the display.
- 3 Connect the red and black test leads to input terminals **V.mV (red)** and **COM (black)** respectively (refer to [Figure 2-2](#)).
- 4 Probe the test points and read the display.
- 5 Press **Dual** to display dual measurements. See [“Selecting display with the Dual button”](#) on page 19 for a list of dual measurements available. Press and hold **Dual** for more than 1 second to exit dual display mode.

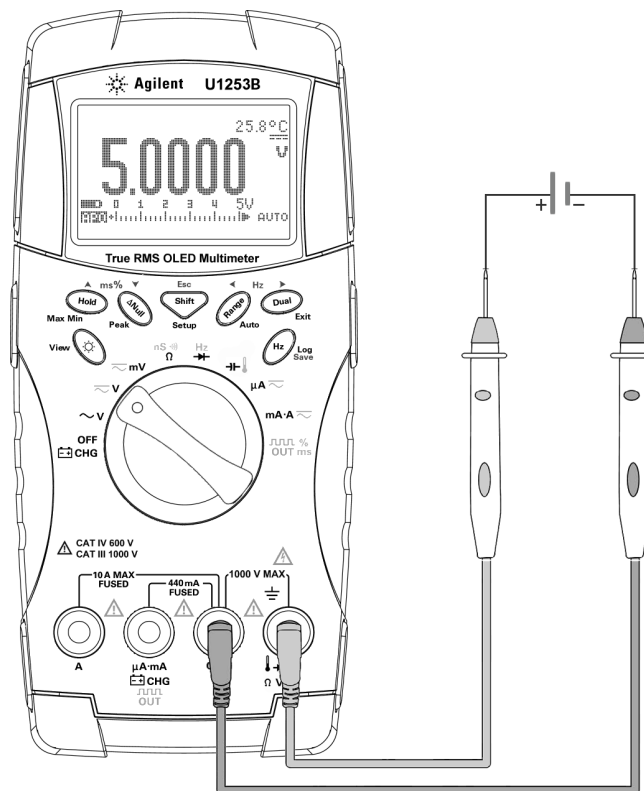









Figure 2-2 Measuring DC voltage

Measuring Current

μA and mA measurement

- 1 Set the rotary switch to μA  or mA·A .
- 2 Press  if necessary to ensure 'AC' is shown on the display.
- 3 Connect the red and black test leads to input terminals $\mu\text{A}\cdot\text{mA}$ (red) and COM (black) respectively (refer to [Figure 2-3](#) on page 34).
- 4 Probe the test points in series with the circuit, and read the display.
- 5 Press  to display dual measurements. See “[Selecting display with the Dual button](#)” on page 19 for a list of dual measurements available. Press and hold  for more than 1 second to exit dual display mode.

NOTE

- for μA measurement, set the rotary switch to μA , and connect the positive test lead to $\mu\text{A}\cdot\text{mA}$.
- for mA measurement, set the rotary switch to mA·A , and connect the positive test lead to $\mu\text{A}\cdot\text{mA}$.
- for A (ampere) measurement, set the rotary switch to mA·A , and connect the positive test lead to A.

2 Making Measurements

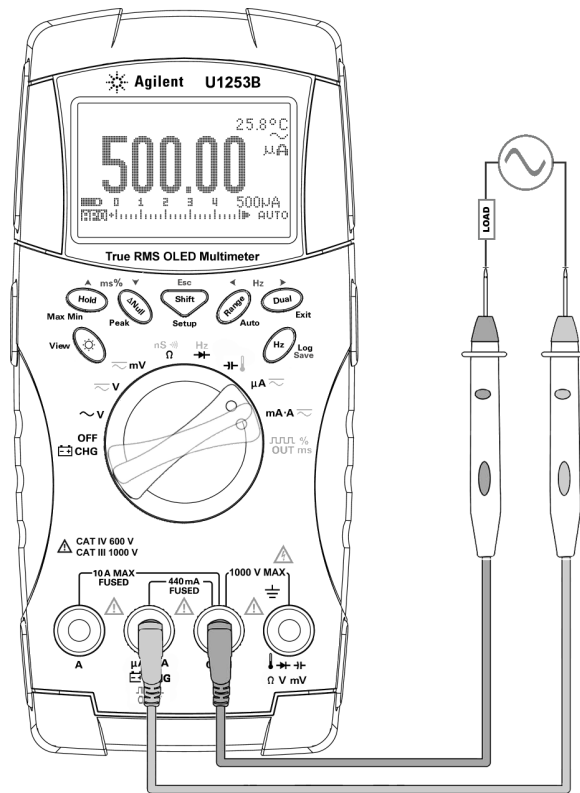







Figure 2-3 Measuring μA and mA current

Percentage scale of 4 mA to 20 mA

- 1 Set the rotary switch to **mA·A** .
- 2 Connect the probes as shown in [Figure 2-3](#) on page 34.
- 3 Press  to select percentage scale display.
Ensure that  or  is shown on the display.

The percentage scale for 4 mA to 20 mA or 0 mA to 20 mA is calculated using its corresponding DC mA measurement. The U1253B will automatically optimize the best resolution according to the table below.

- 4 Press  to change the measurement range.

The percentage scale for 4 mA to 20 mA or 0 mA to 20 mA is set to two ranges as follows:

Table 2-1 Percentage scale and measurement range

Percentage scale (4 mA to 20 or 0 mA to 20 mA) Always auto range	DC mA auto or manual range
999.99%	50 mA, 500 mA
9999.9%	

2 Making Measurements

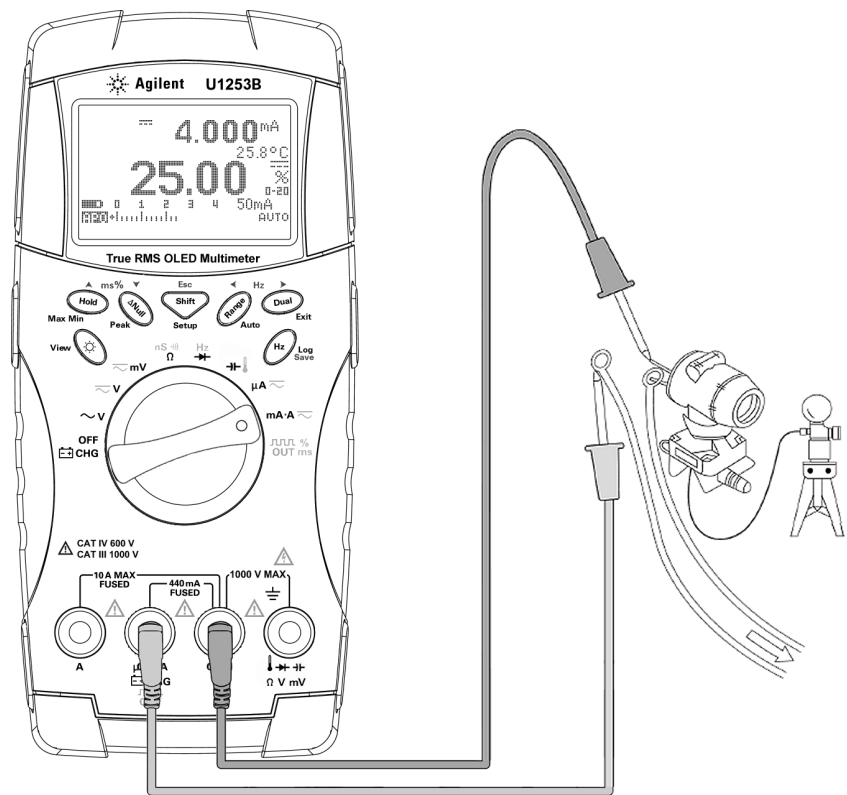



Figure 2-4 Measurement scale of 4 mA to 20 mA

A (ampere) measurement

- 1 Set the rotary switch to **mA·A** .
- 2 Connect the red and black test leads to 10 A input terminals **A (red)** and **COM (black)** respectively (see [Figure 2-5](#)). When the red test lead is plugged into the **A (red)** terminal, the multimeter is automatically set to  measurement.

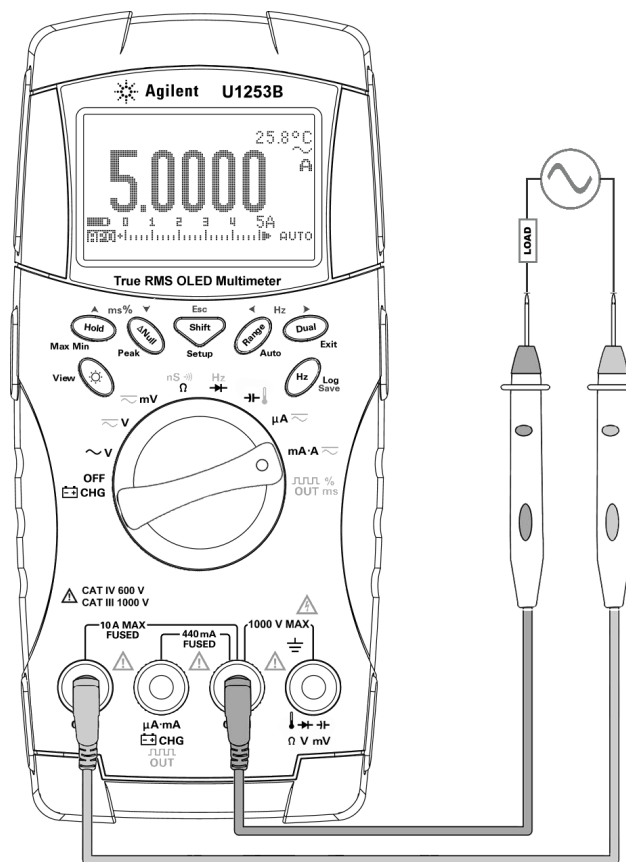





Figure 2-5 A (ampere) current measurement

Frequency Counter

WARNING

- Use the frequency counter only for low voltage applications. Never use the frequency counter on an AC power line system.
- For input more than 30 Vpp, you are required to use frequency measurement mode available under the current or voltage measurement instead of frequency counter.

- 1 Set the rotary switch to **Hz**.
- 2 Press  to select the Frequency Counter () function. The default input signal frequency is divided by 1. This allows signals up to a maximum frequency of 985 kHz to be measured.
- 3 Connect the red and black test leads to input terminals **V (red)** and **COM (black)** respectively (refer to [Figure 2-6](#) on page 39).
- 4 Probe the test points and read the display.
- 5 If the reading is unstable or zero, press  to select division of input signal frequency by 100 ( will be shown on the display). This accommodates a higher frequency range of up to 20 MHz.
- 6 The signal is out of the U1253B frequency measurement range of 20 MHz if the reading is still unstable after [Step 5](#).

NOTE

Press  to scroll through the pulse width (ms), duty cycle (%), and frequency (Hz) measurements.

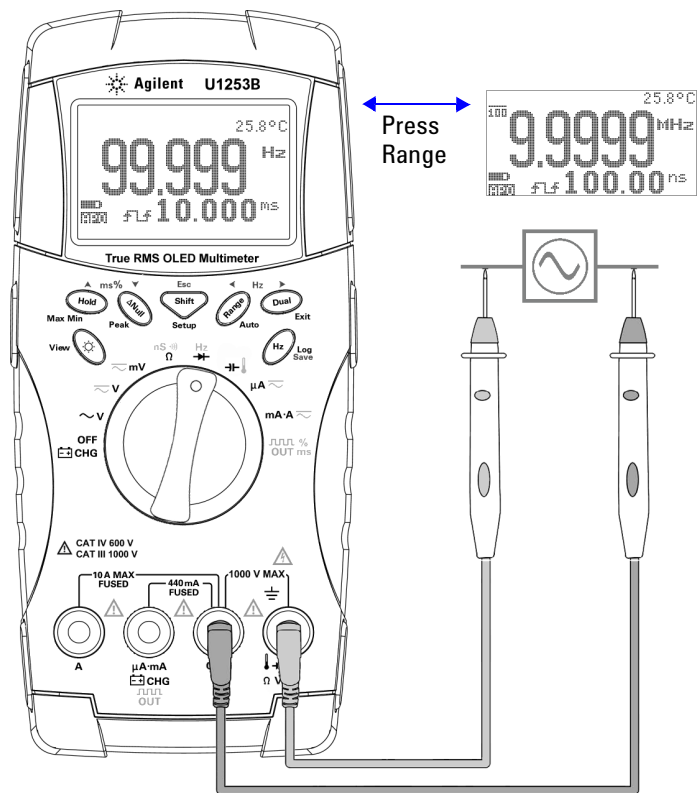









Figure 2-6 Measuring frequency

Measuring Resistance, Conductance, and Testing Continuity

CAUTION

Disconnect circuit power and discharge all high-voltage capacitors before measuring resistance or conductance, or testing circuit continuity, to avoid damaging the multimeter or the device under test.

- 1 Set the rotary switch to . The default function is resistance measurement.
- 2 Connect the red and black test leads to input terminals Ω (red) and COM (black) respectively (see [Figure 2-8](#) on page 42).
- 3 Probe the test points (by shunting the resistor) and read the display.
- 4 Press  to scroll through audible continuity test () or , depending on Setup configuration), conductance measurement () and resistance measurement (, , or ) as shown in [Figure 2-9](#) on page 43.

Smart Ω

Using the offset compensation method, Smart Ω removes unexpected DC voltages within instrument, at the input, or the circuit being measured, which will add error to resistance measurement. Besides, it also displays the bias voltage or leakage current (calculated based on bias voltage and corrected resistance value) on the secondary display. With offset compensation method, the multimeter takes the difference between two resistance measurements when two different test currents are applied to determine any offset voltage in the input circuitry. The resultant displayed measurement corrects this offset, giving a more accurate resistance measurement.

The Smart Ω is applicable for 500 Ω , 5 k Ω , 50 k Ω , and 500 k Ω resistance range only. The maximum correctable offset/bias voltage is ± 1.9 V for 500 Ω range and ± 0.35 V for 5 k Ω , 50 k Ω , and 500 k Ω range.

- Press **Dual** to enable Smart Ω feature. Press **Dual** again to cycle through Bias display or Leak display.
- Press **Dual** for more than one second to disable Smart Ω feature.

NOTE

The measurement time increases when Smart Ω is enabled.

Bias Display

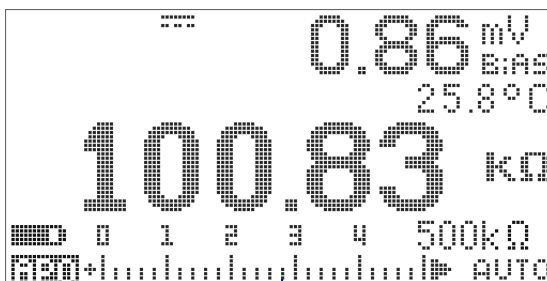

Leak Display

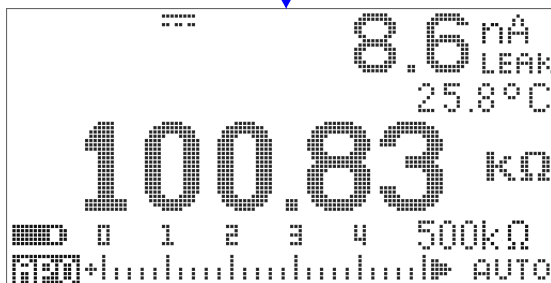

Figure 2-7 Type of display when Smart Ω is enabled

2 Making Measurements

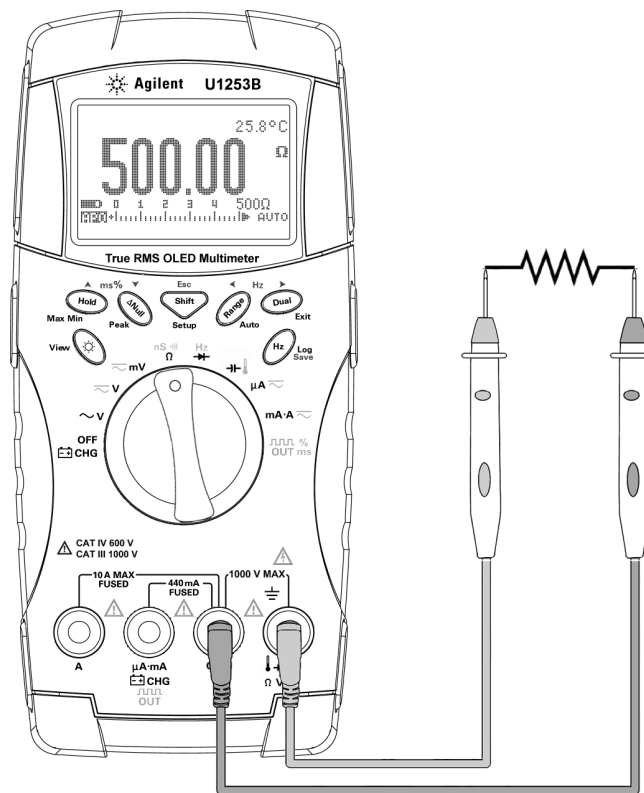

Figure 2-8 Measuring resistance

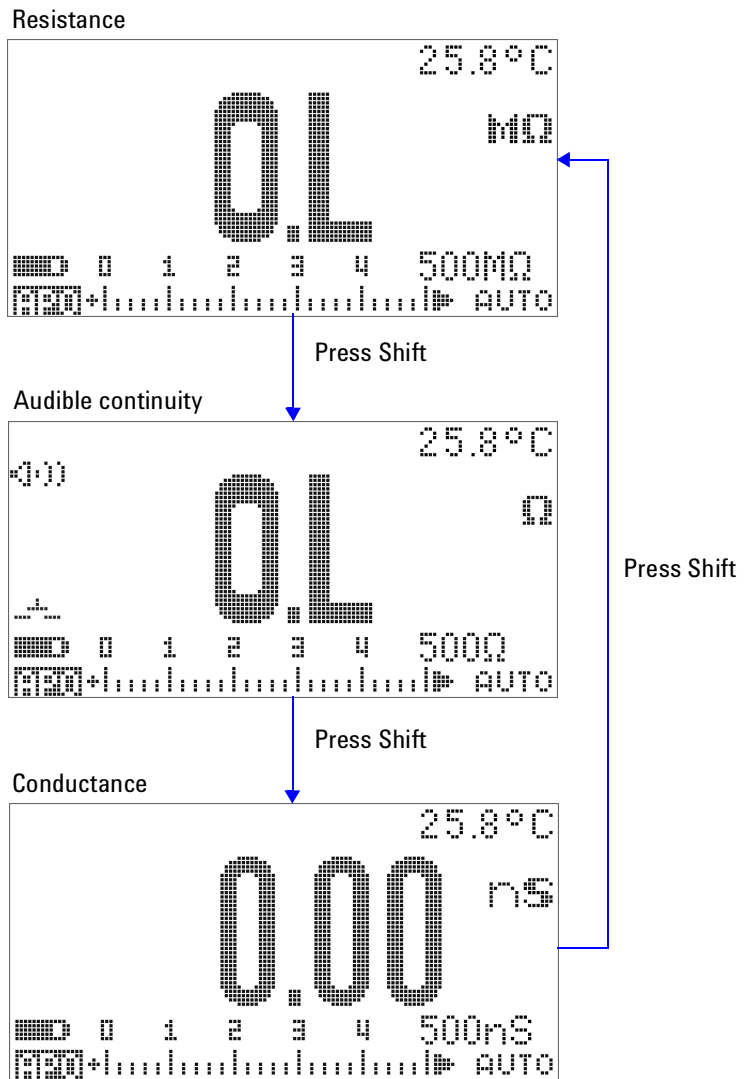

Figure 2-9 Resistance, audible continuity, and conductance tests

Audible Continuity

For the 500 Ω range, the beeper will emit a sound if the resistance value falls below 10 Ω . For other ranges, the beeper will emit a sound if the resistance falls below the typical values listed in the table below.

Table 2-2 Audible continuity measurement range

Measurement range	Beeper sound threshold
500.00 Ω	< 10 Ω
5.0000 k Ω	< 100 Ω
50.000 k Ω	< 1 k Ω
500.00 k Ω	< 10 k Ω
5.0000 M Ω	< 100 k Ω
50.000 M Ω	< 1 M Ω
500.00 M Ω	< 10 M Ω

NOTE

When testing continuity, you can choose to test either short continuity or open continuity.

- By default, the multimeter is set to short continuity.
- Press  to select open continuity.

Short Continuity

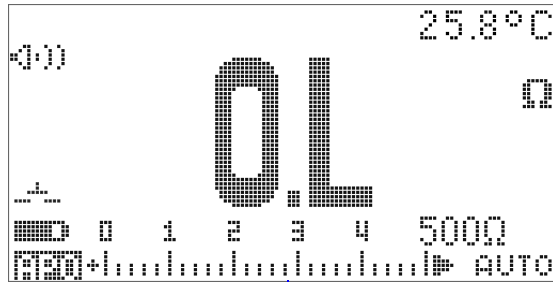

Press 

Open Continuity

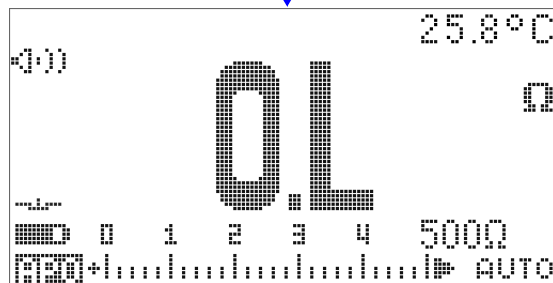

Press 

Figure 2-10 Short continuity and open continuity test

Conductance

The conductance measurement function makes it easier to measure very high resistance of up to 100 GΩ (refer to [Figure 2-11](#) on page 46 for probe connection). As high-resistance readings are susceptible to noise, you can capture average readings using the Dynamic Recording mode. See [Figure 3-1](#) on page 77.

2 Making Measurements

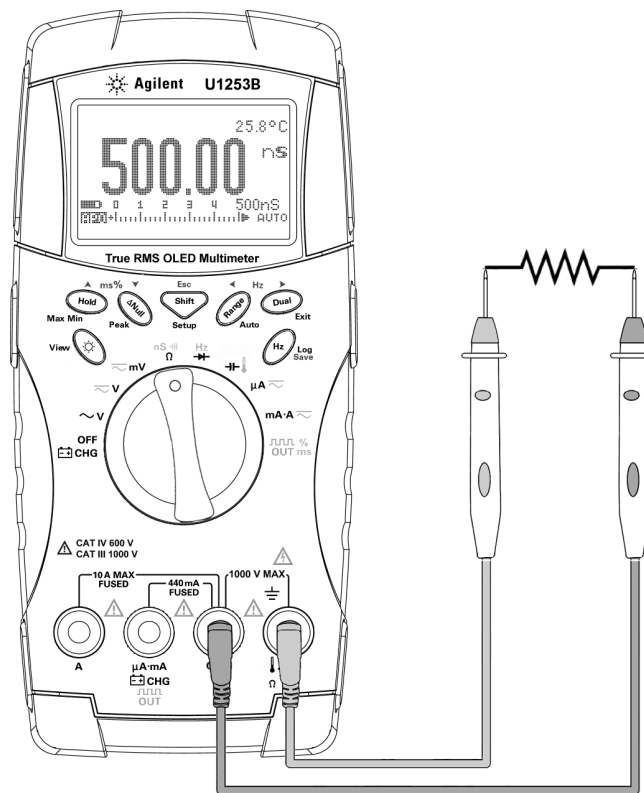



Figure 2-11 Conductance measurement

Testing Diodes

CAUTION

Disconnect circuit power and discharge all high-voltage capacitors before testing diodes to avoid damaging the multimeter.

To test a diode, switch the circuit power off, and remove the diode from the circuit. Then proceed as follows:

- 1 Set the rotary switch to **Hz** . The default function is diode measurement.
- 2 Connect the red and black test leads to input terminals  (**red**) and **COM (black)** respectively.
- 3 Connect the red test lead to the positive terminal (anode) of the diode and the black test lead to the negative terminal (cathode). Refer to [Figure 2-12](#) on page 48.

NOTE

The cathode of a diode is indicated with a band.

- 4 Read the display.

NOTE

This multimeter can display diode forward bias of up to approximately 3.1 V. The forward bias of a typical diode is within the range of 0.3 V to 0.8 V.

- 5 Reverse the probes and measure the voltage across the diode again (refer to [Figure 2-13](#) on page 49). Assess the diode according to the following guidelines:
 - A diode is considered good if the multimeter displays “**OL**” in reverse bias mode.
 - A diode is considered shorted if the multimeter displays approximately 0 V in both forward and reverse bias modes, and the multimeter beeps continuously.
 - A diode is considered open if the multimeter displays “**OL**” in both forward and reverse bias modes.

2 Making Measurements

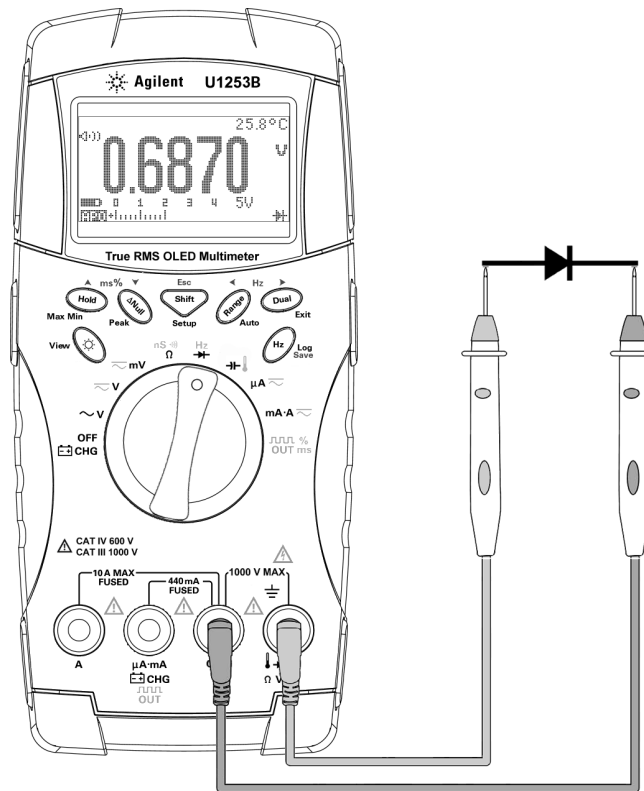

Figure 2-12 Measuring the forward bias of a diode

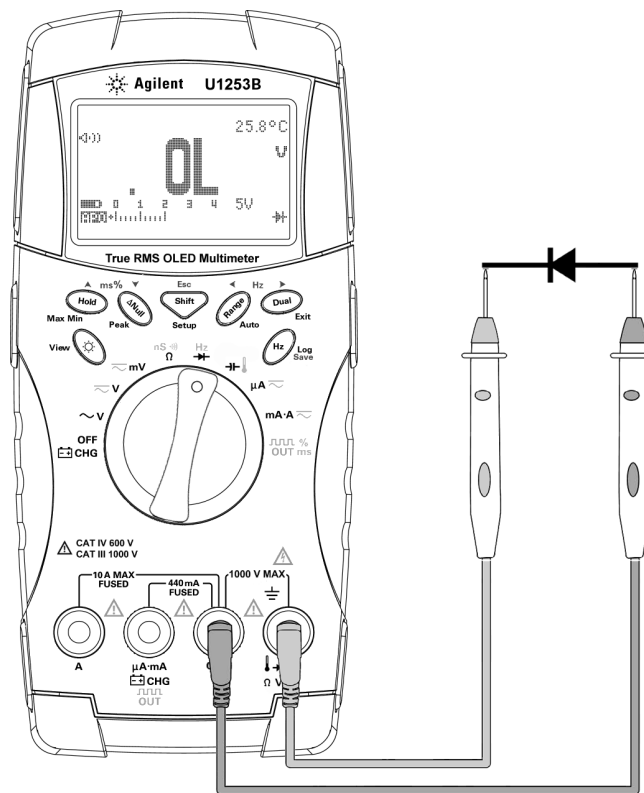

Figure 2-13 Measuring the reverse bias of a diode

Measuring Capacitance

CAUTION



Disconnect circuit power and discharge all high-voltage capacitors before measuring capacitance to avoid damaging the multimeter or the device under test. To confirm that a capacitor has fully discharged, use the DC voltage function.



The U1253B true RMS OLED multimeter calculates capacitance by charging a capacitor with a known current for a period of time, and then measuring the voltage

Measuring tips:

- For measuring capacitance values greater than 10000 μF , discharge the capacitor first, then select a suitable range for measurement. This will speed up the measurement time and also ensure that the correct capacitance value is obtained.
- For measuring small capacitance values, press  with the test leads open to subtract the residual capacitance of the multimeter and leads.

NOTE

 means that the capacitor is charging.  means that the capacitor is discharging.

- 1 Set the rotary switch to .
- 2 Connect the red and black test leads to input terminals ** (red)** and **COM (black)** respectively.
- 3 Use the red test lead on the positive terminal of the capacitor and the black test lead on the negative terminal.
- 4 Read the display.



Measuring Temperature

CAUTION



Do not bend the thermocouple leads at sharp angles. Repeated bending over a period of time can break the leads.

The bead-type thermocouple probe is suitable for measuring temperatures from $-20\text{ }^{\circ}\text{C}$ to $204\text{ }^{\circ}\text{C}$ in Teflon-compatible environments. Above this temperature range, the probe may emit toxic gas. Do not immerse this thermocouple probe in any liquid. For best results, use a thermocouple probe designed for each specific application – an immersion probe for liquid or gel, and an air probe for air measurement. Observe the following measurement techniques:

- Clean the surface to be measured and ensure that the probe is securely touching the surface. Remember to disable the applied power.
- When measuring above ambient temperatures, move the thermocouple along the surface until you get the highest temperature reading.
- When measuring below ambient temperatures, move the thermocouple along the surface until you get the lowest temperature reading.
- Place the multimeter in the operating environment for at least 1 hour as the multimeter is using a non-compensation transfer adapter with miniature thermal probe.
- For quick measurement, use the $0\text{ }^{\circ}\text{C}$ compensation to view the temperature variation of the thermocouple sensor. The $0\text{ }^{\circ}\text{C}$ compensation assists you in measuring relative temperature immediately.

- 1 Set the rotary switch to .
- 2 Press  to select temperature measurement.
- 3 Plug the thermocouple adapter (with the thermocouple probe connected to it) into input terminals **TEMP (red)** and **COM (black)** (as shown in [Figure 2-14](#) on page 53)
- 4 Touch the surface to be measured with the thermocouple probe.
- 5 Read the display.

If you are working in a constantly varying environment, where ambient temperatures are not constant, do the following:

- 1 Press  to select 0 °C compensation. This allows a quick measurement of the relative temperature.
- 2 Avoid contact between the thermocouple probe and the surface to be measured.
- 3 After a constant reading is obtained, press  to set the reading as the relative reference temperature.
- 4 Touch the surface to be measured with the thermocouple probe.
- 5 Read the display for the relative temperature.

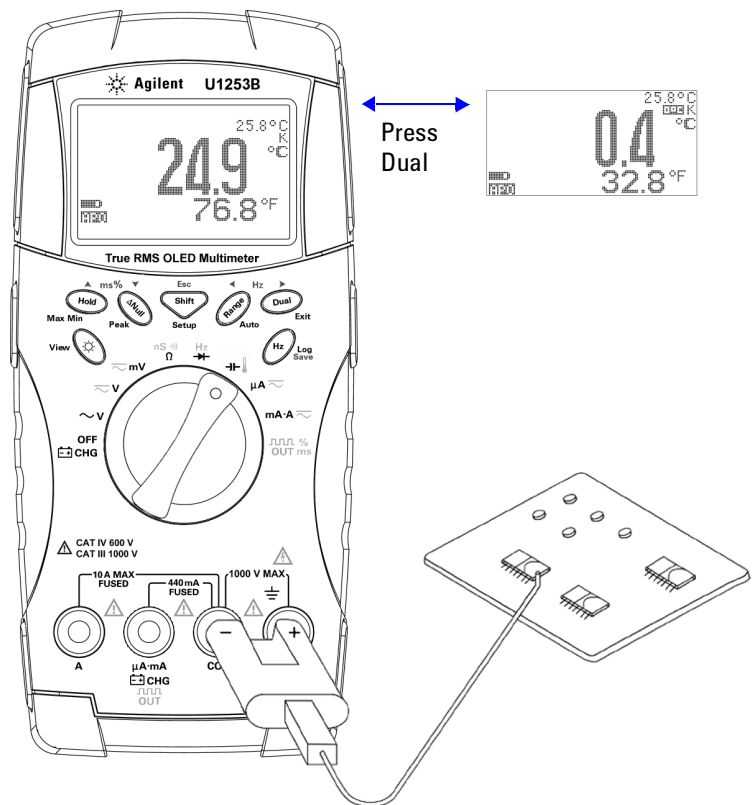

Figure 2-14 Surface temperature measurement

Alerts and Warning During Measurement

Voltage alert

WARNING

For your own safety, please do not ignore the voltage alert. When the multimeter gives you a voltage alert, immediately remove the test leads from the source being measured.

This multimeter provides a voltage alert for voltage measurement in both auto and manual range modes. The multimeter starts beeping periodically once the measured voltage exceeds the **V-ALERT** value set in the Setup mode. Immediately remove the test leads from the source being measured.

By default, this feature is turned off. Be sure to set the alerting voltage according to your requirement.

The multimeter will also display  as an early warning for hazardous voltage when the measured voltage is equal to or greater than 30 V in all three DC V, AC V and AC+DC V measurement modes.

For a manually selected measurement range, when the measured value is outside the range, the display will indicate **OL**.

Input warning

The multimeter emits a continuous alerting beep when the test lead is inserted to the **A** input terminal but the rotary switch is not set to the corresponding **mA.A** position. A warning message **Error ON A INPUT** will be displayed until the test lead is removed from the **A** input terminal. See [Figure 2-15](#).

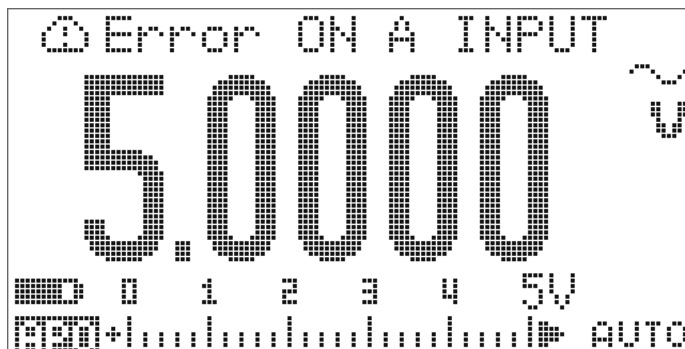

Figure 2-15 Input terminal warning

Charge terminal alert

The multimeter emits a continuous alerting beep when the **CHG** terminal detects a voltage level of more than 5 V and the rotary switch is not set to the corresponding **OFF** position. A warning message **Error ON mA INPUT** will be displayed until the lead is removed from the **CHG** input terminal. See [Figure 2-16](#).

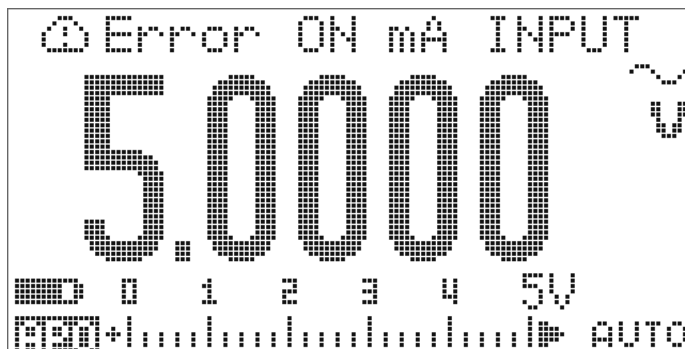

Figure 2-16 Charge terminal alert



3 Functions and Features

Dynamic Recording	58
Data Hold (Trigger Hold)	60
Refresh Hold	62
Null (Relative)	64
Decibel Display	66
1 ms Peak Hold	69
Data Logging	71
Manual logging	71
Interval logging	73
Reviewing logged data	75
Square wave Output	77
Remote Communication	81









This chapter contains detailed information on functions and features available in the U1253B true RMS OLED multimeter.





Dynamic Recording

The Dynamic Recording mode can be used to detect intermittent turn-on or turn-off voltage or current surges, and to verify measurement performance without you being present during the process. While the readings are being recorded, you may perform other tasks.

The average reading is useful for smoothing out unstable inputs, estimating the percentage of time a circuit is operating, and verifying circuit performance. The elapsed time is shown on the secondary display. The maximum time is 99999 seconds. When this maximum time is exceeded, "OL" is indicated on the display.

- 1 Press  for more than 1 second to enter the Dynamic Recording mode. The multimeter is now in continuous mode or non-data hold (non-trigger) mode.  and the present measurement value is displayed. The beeper emits a sound when a new maximum or minimum value is recorded.
- 2 Press  to cycle through maximum (), minimum (), average (), and present readings (.
- 3 Press  or  for more than 1 second to exit Dynamic Recording mode.

NOTE

- Press  to restart dynamic recording.
- The average value is the true average of all measured values taken in the Dynamic recording mode. If an overload is recorded, the averaging function will stop and the average value becomes "OL" (overload). Auto Power Off  is disabled in Dynamic Recording mode.

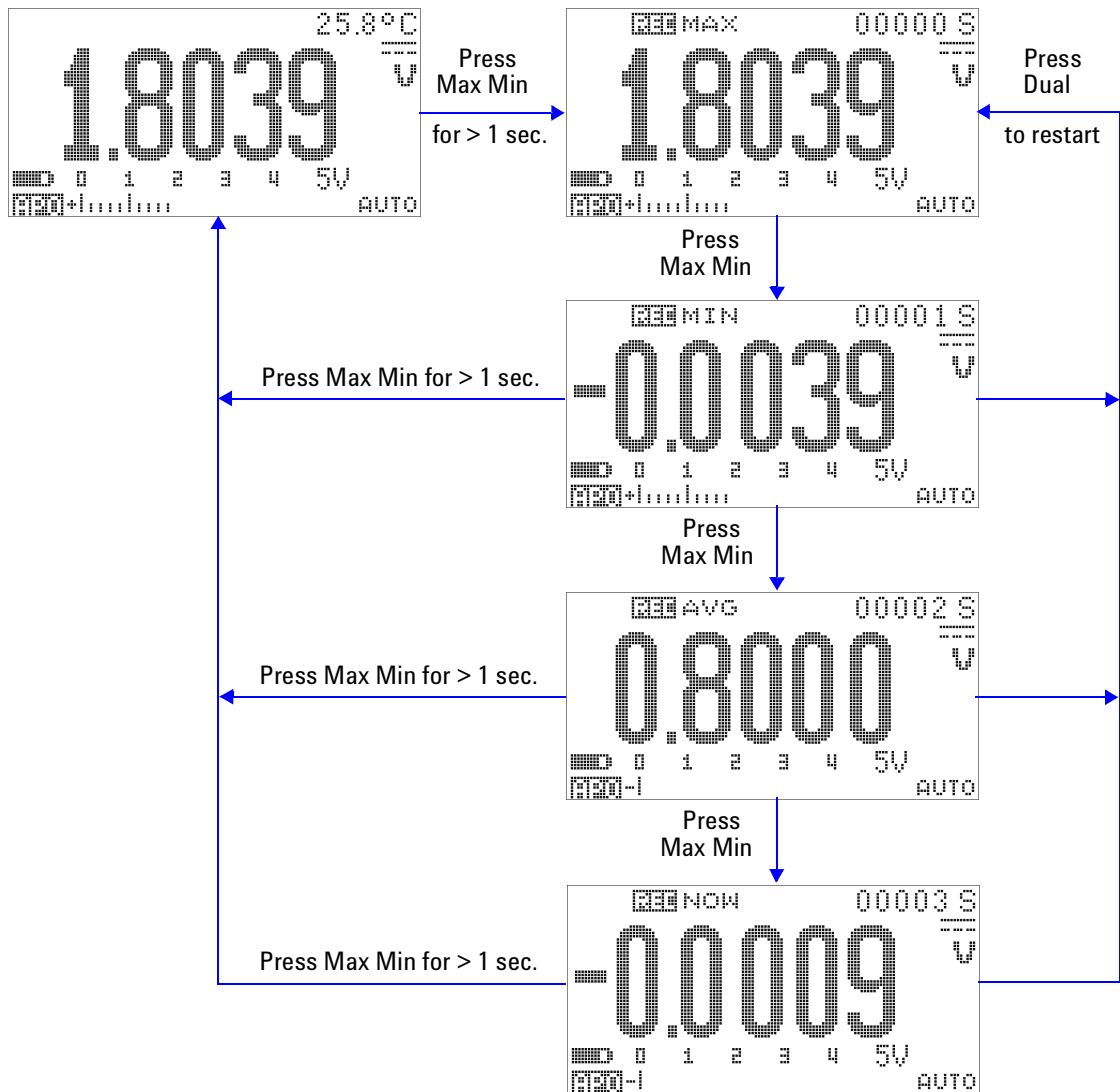

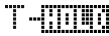

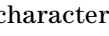





Figure 3-1 Dynamic recording mode operation

Data Hold (Trigger Hold)

The Data Hold function allows you to freeze the displayed value.

- 1 Press  to freeze the displayed value and to enter manual trigger mode.  is displayed.
- 2 Press  again to trigger the freezing of the next measured value. The character “T” in the  annunciator flashes before the new value is updated on the display.
- 3 While in the Data Hold mode, you may press  to switch between DC, AC, and AC+DC measurements.
- 4 Press and hold  or  for more than 1 second to quit this mode.

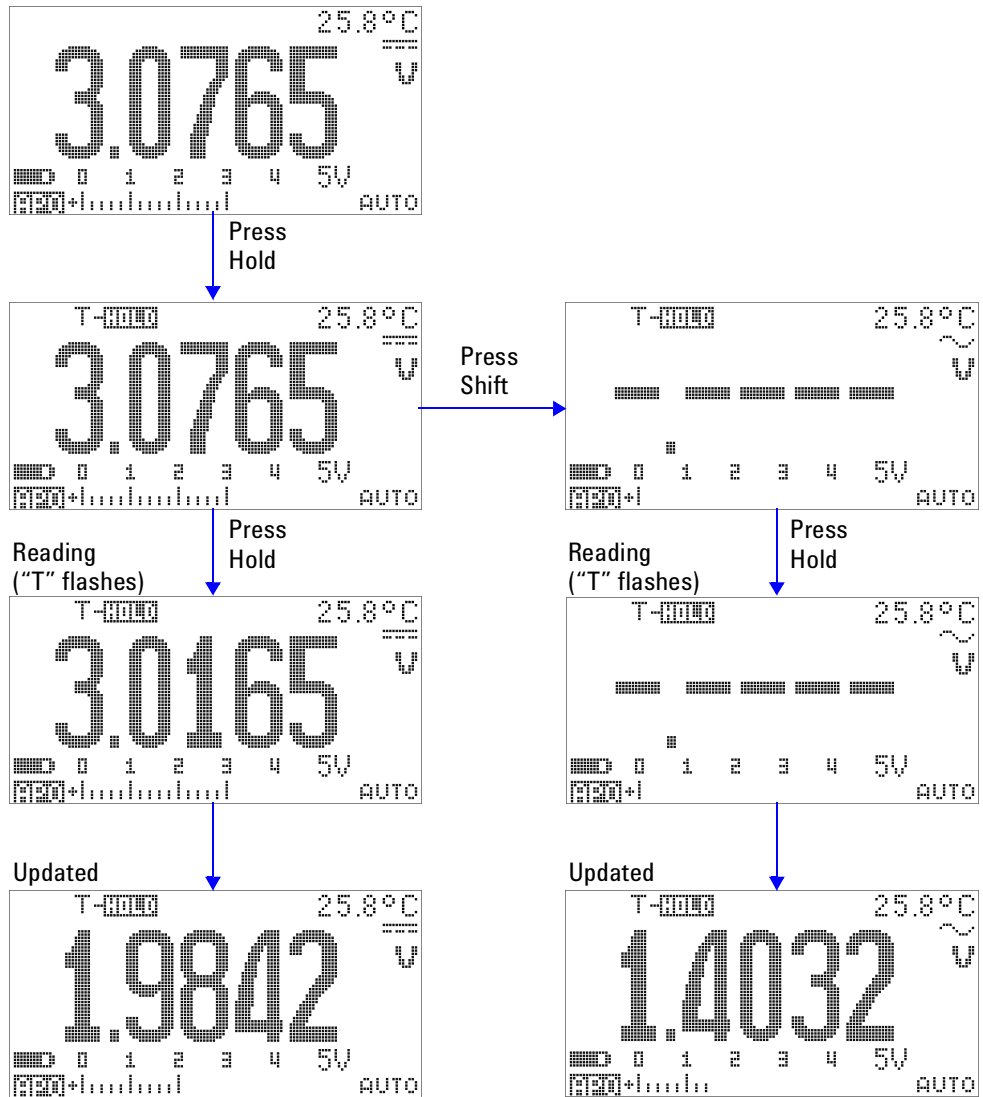









Figure 3-2 Data hold mode operation

Refresh Hold

The Refresh Hold function allows you to freeze the displayed value. The bar-graph is not held, and will continue to reflect the instantaneous measured value. You can use the Setup mode to enable Refresh Hold mode when you are working with fluctuating values. This function will auto trigger or update the held value with a new measured value, and emit a tone to remind you.

- 1 Press  to enter Refresh Hold mode. The present value will be held, and the  annunciator will turn on.
- 2 It will be ready to freeze a new measured value once the variation of measured values exceeds the variation count setting. While the multimeter is waiting for a new stable value, the character “R” in the  annunciator will flash.
- 3 The  annunciator will stop flashing once the new measured value is stable, and then the new value will be updated to the display. The  annunciator will again remain on and the multimeter will emit a tone to remind you.
- 4 While in the Refresh Hold mode, you may press  to switch between DC, AC, and AC+DC measurements.
- 5 Press  again to disable this function. You may also press  for more than 1 second to quit this function.

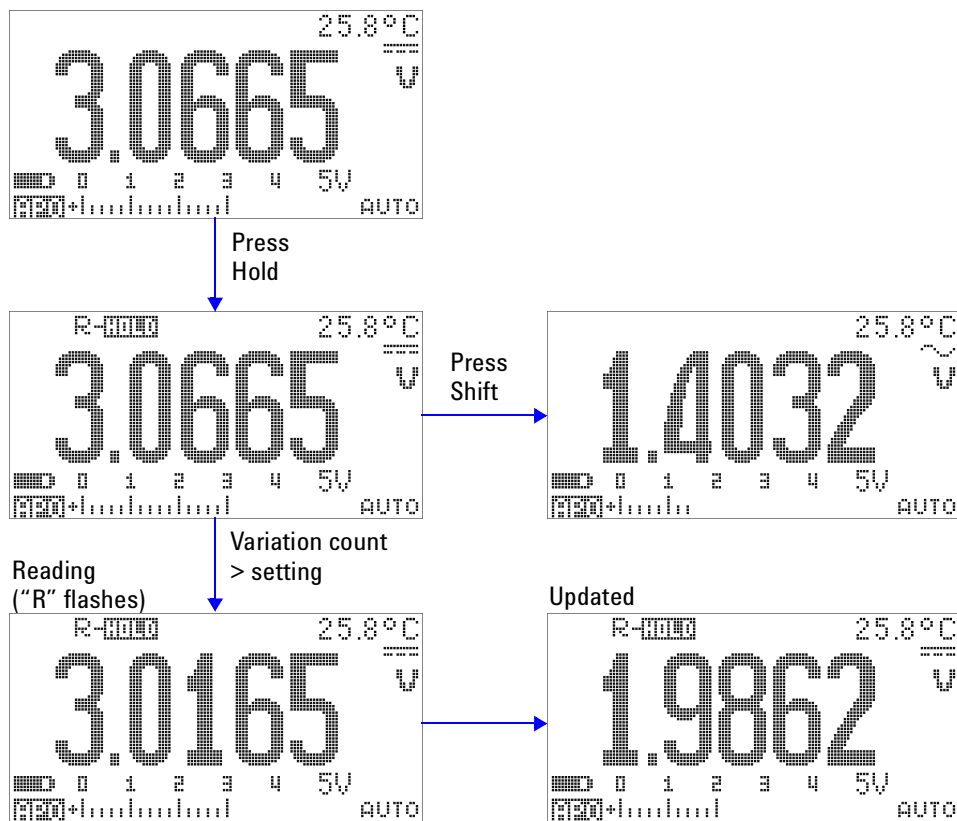



Figure 3-3 Refresh hold mode operation

NOTE

- For voltage and current measurements, the held value will not be updated if the reading is below 500 counts.
- For resistance and diode measurements, the held value will not be updated if the reading is "OL" (open state).
- For all types of measurement, the held value will not be updated until the reading has reached a stable state.



Null (Relative)

The Null function subtracts a stored value from the present measurement and displays the difference between the two.

- 1 Press  to store the displayed reading as the reference value to be subtracted from subsequent measurements and to set the display to zero. Δ NULL is displayed.

NOTE

Null can be set for both auto and manual range settings, but not in the case of an overload.

- 2 Press  to view the stored reference value. 0 BASE and the stored reference value are displayed for 3 seconds.
- 3 To exit this mode:
 - press  within the 3 seconds when 0 BASE and the stored reference value is displayed, or
 - press  for more than 1 second.

NOTE

- In resistance measurement mode, the multimeter will read a non-zero value even when the two test leads are in direct contact, because of the resistance of these leads. Use the Null function to zero-adjust the display.
- In DC voltage measurement mode, thermal effects will influence the accuracy. Short the test leads and press  once the displayed value is stable to zero-adjust the display.

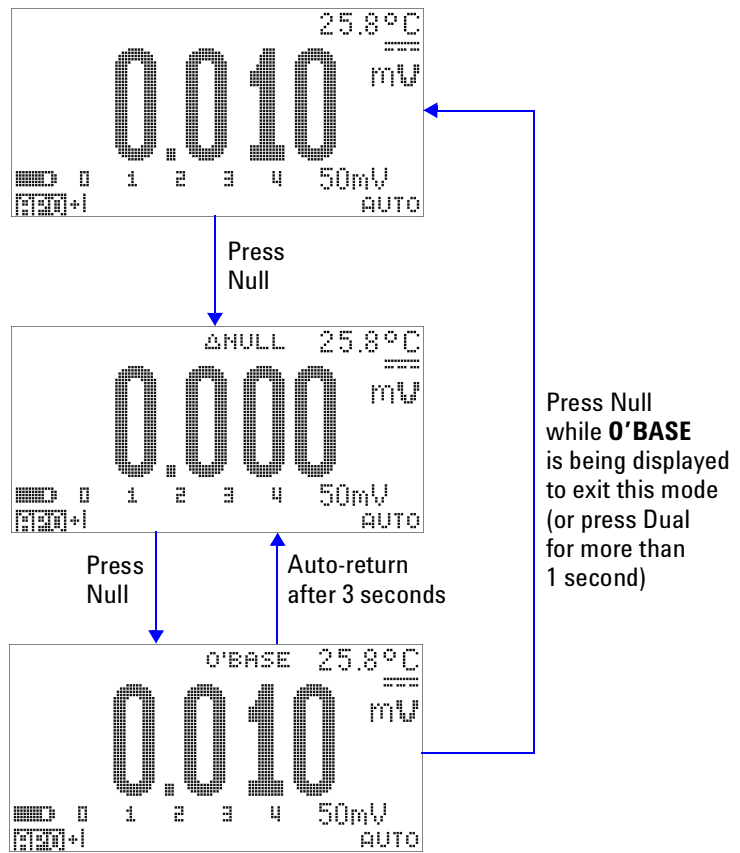

Figure 3-4 Null (relative) mode operation

Decibel Display





The dBm unit calculates the power delivered to a reference resistance relative to 1 mW, and can be applied to DC V, AC V, and AC+DC V measurements for decibel conversion. Voltage measurement is converted to dBm using the following formula:

$$dBm = 10\log\left(\frac{1000 \times (\textit{measured voltage})^2}{\textit{reference impedance}}\right) \quad (1)$$

The reference impedance may be specified from 1 Ω to 9999 Ω in Setup mode. The default value is 50 Ω .

The dBV unit calculates the voltage with respect to 1 V. The formula is as shown below:

$$dBV = 20\log(\textit{measured voltage}) \quad (2)$$

- 1 With the rotary switch set at  V,  V, or  mV, press  to navigate to dBm or dBV^[1] measurement on the primary display. The voltage measurement is indicated on the secondary display.
- 2 Press  for more than 1 second to exit this mode.

^[1] Depends on configuration in Setup mode.

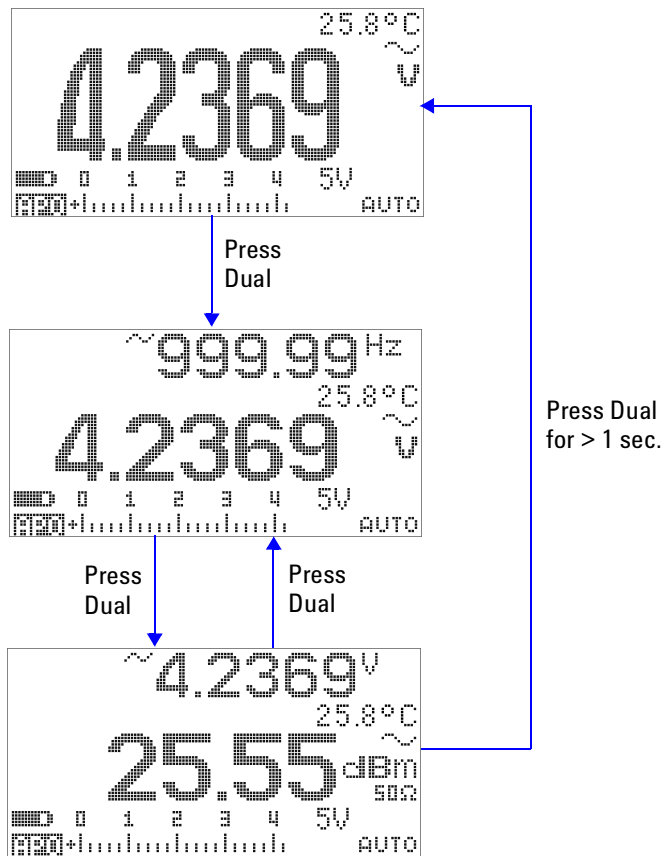

Figure 3-5 dBm display mode operation

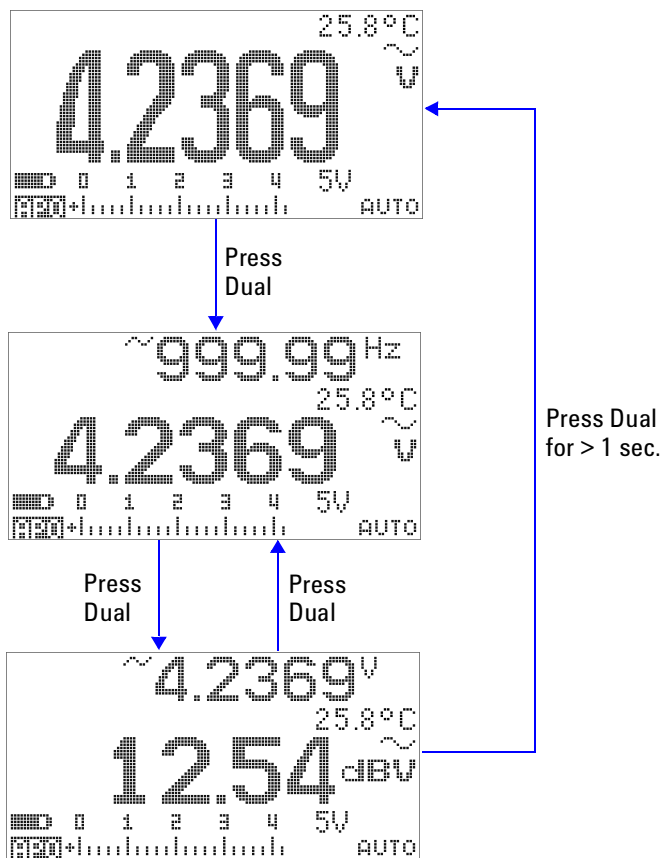





Figure 3-6 dBV display mode operation



1 ms Peak Hold



This function allows the measurement of peak voltage for analysis of components such as power distribution transformers and power factor correction capacitors. The peak voltage obtained can be used to determine the crest factor:

$$\text{Crest factor} = \frac{\text{Peak value}}{\text{True RMS value}} \quad (3)$$

- 1 Press  for more than 1 second to toggle 1 ms Peak Hold mode ON and OFF.
- 2 Press  to switch between maximum and minimum peak readings.  indicates maximum peak, while  indicates minimum peak.

NOTE

- If the reading is “OL”, press  to change the measurement range and to restart peak-recording measurement.
- If you need to restart peak recording without changing the range, press .

- 3 Press  or  for more than 1 second to exit this mode.
- 4 In the measurement example shown in [Figure 3-7](#) on page 70, the crest factor will be $2.2669/1.6032 = 1.414$.

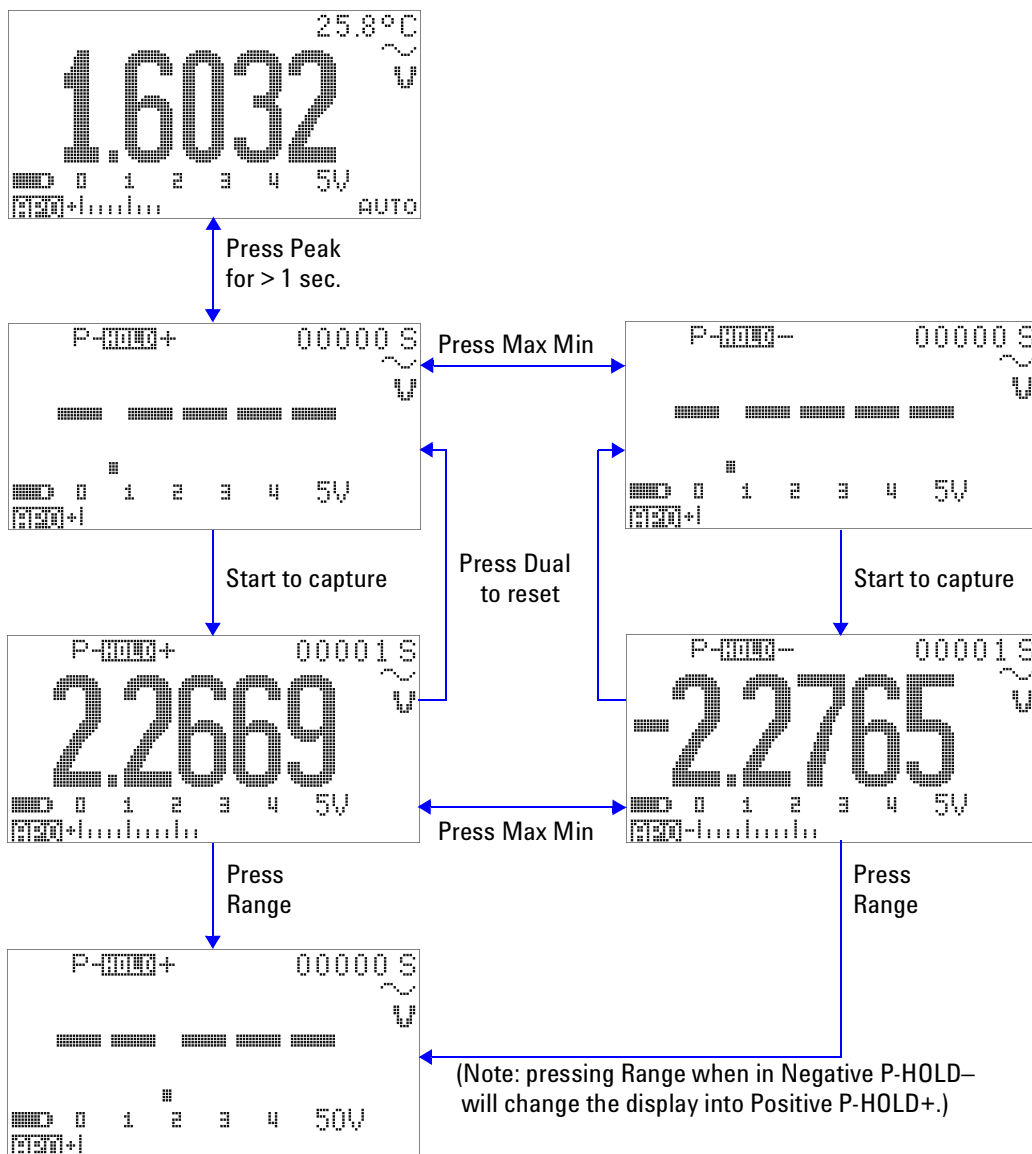

Figure 3-7 1 ms peak hold mode operation

Data Logging



The data logging function provides the convenience of recording test data for future review or analysis. Since data is stored in nonvolatile memory, the data remains saved when the multimeter is turned OFF or the battery is changed.

The two options offered are manual (hand) logging and interval (time) logging functions, which is determined in the Setup mode.

Data logging records the values on the primary display only.

Manual logging

First of all, ensure that manual (hand) logging is specified in Setup mode.

- 1 Press  for more than 1 second to store the present value and function on the primary display in the meters memory.  and the logging index are displayed for 3 seconds.
- 2 Press and hold  again for the next value that you would like to save into the memory.

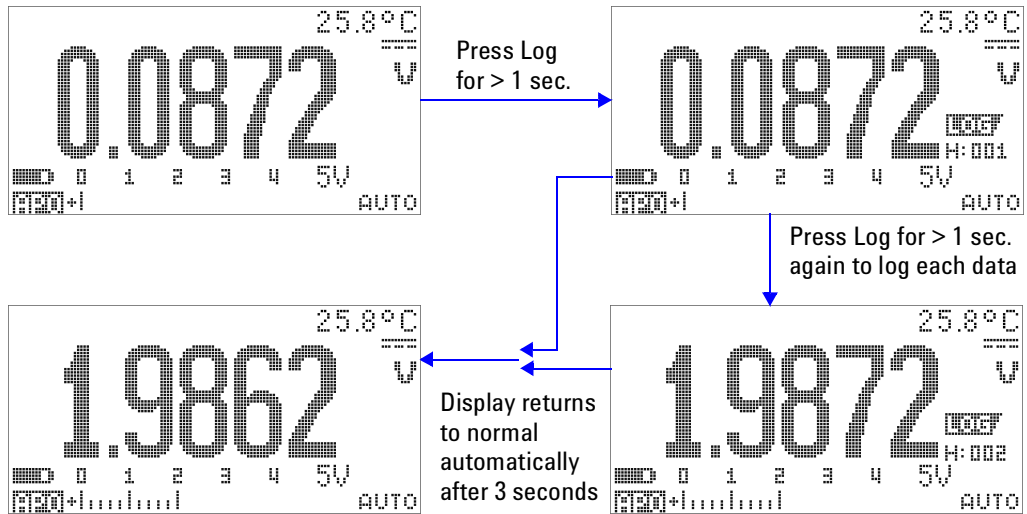

Figure 3-8 Manual (hand) logging mode operation

NOTE

The maximum number of readings that can be stored is 100 entries. When the 100 entries are all occupied, the logging index will indicate “Full”, as shown in [Figure 3-9](#).

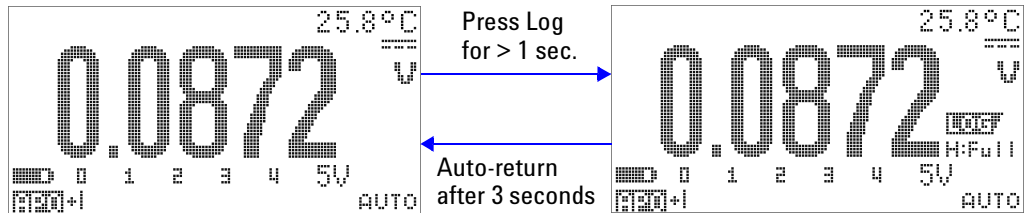



Figure 3-9 Full log

Interval logging

First of all, ensure that interval (time) logging is specified in Setup mode.

- 1 Press  for more than 1 second to store the present value and function on the primary display into the meters memory.  and the logging index are indicated. Subsequent readings are automatically logged into the memory at the interval (LOG TIME) specified in Setup mode. Refer to [Figure 3-10](#) on page 74 for how to operate this mode.

NOTE

The maximum number of readings that can be stored is 1000 entries. When the 1000 entries are all occupied, the logging index will indicate "Full".

- 2 Press  for more than 1 second to exit this mode.

NOTE

When interval (time) logging is running, all keypad operations are disabled, except for **Log**, which, when pressed for longer than 1 second, will exit this mode. Furthermore, Auto Power Off is disabled during interval logging.

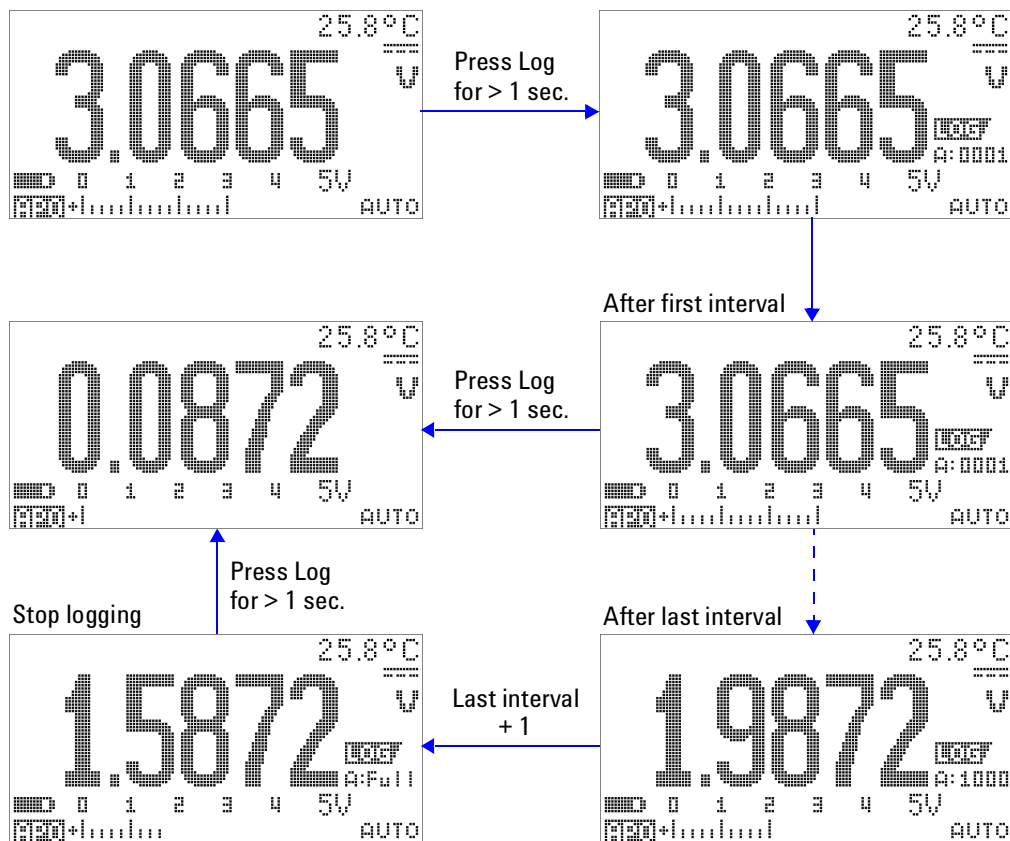











Figure 3-10 Interval (time) logging mode operation

Reviewing logged data

- 1 Press  for more than 1 second to enter Log Review mode. The last logged entry, , and the last logging index are displayed.
- 2 Press  to switch between manual (hand) and interval (time) logging review mode.
- 3 Press  to ascend or  to descend through the logged data. Press  to select first record and  to select the last record for quick navigation.
- 4 Press  for more than 1 second at the respective Log Review mode to clear logged data.
- 5 Press  for more than 1 second to stop logging and exit this mode.

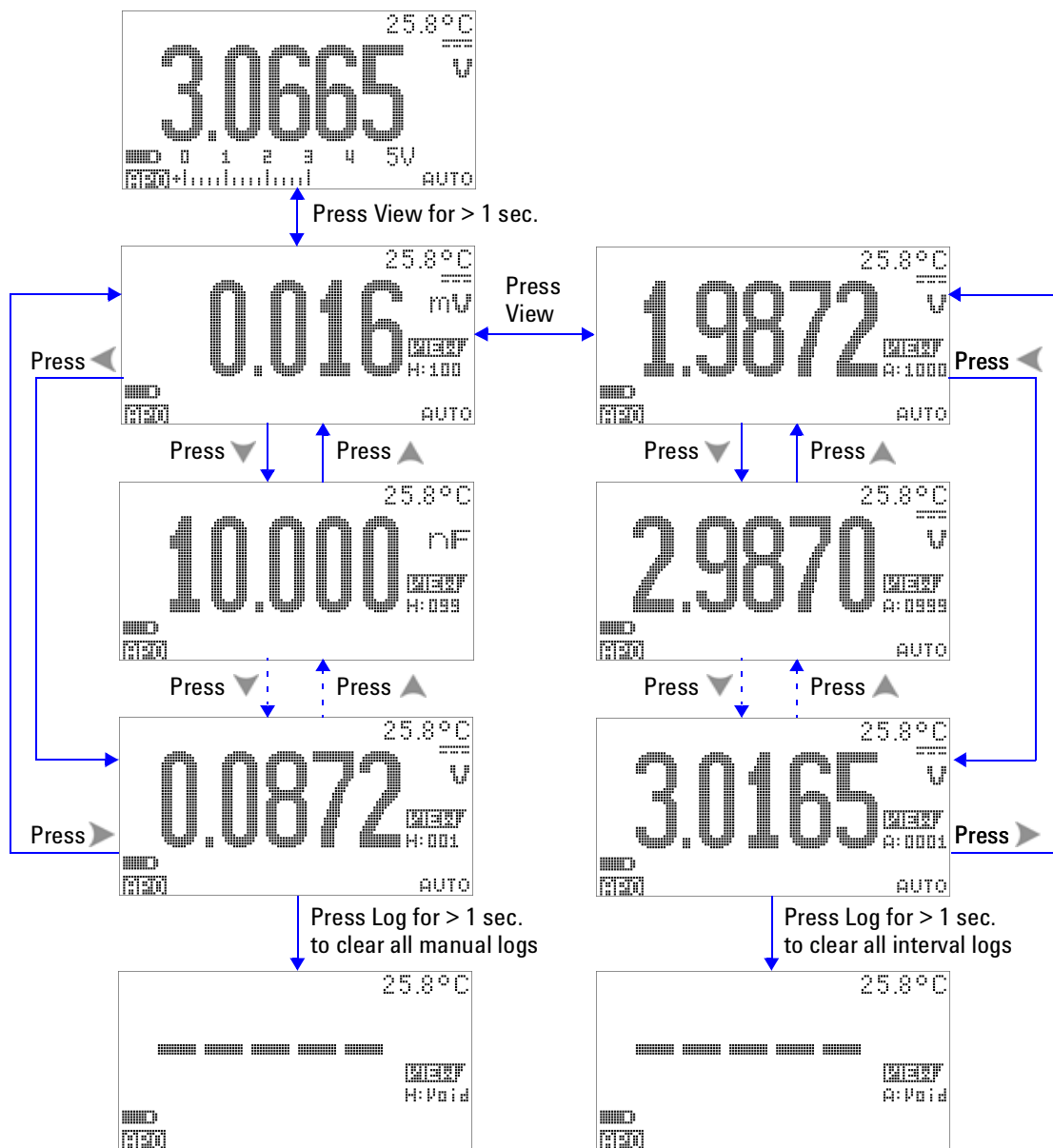

Figure 3-11 Log review mode operation

Square wave Output

The U1253B true RMS OLED multimeter’s square wave output can be used to generate a PWM (pulse width modulation) output or provide a synchronous clock source (baud rate generator). You can also use this function to check and calibrate flow-meter displays, counters, tachometers, oscilloscopes, frequency converters, frequency transmitters, and other frequency input devices.

Selecting square wave output frequency





- 1 Set the rotary switch to  **OUT** **%** **ms**. The default pulse width is 0.8333 ms and default frequency is 600 Hz, as shown on the primary and secondary displays respectively.
- 2 Press  to switch between duty cycle and pulse width for the primary display.
- 3 Press  or  to scroll through the available frequencies (there are 29 frequencies to choose from).

Table 3-1 Available frequencies for square wave output

Frequency (Hz)
0.5, 1, 2, 5, 6, 10, 15, 20, 25, 30, 40, 50, 60, 75, 80, 100, 120, 150, 200, 240, 300, 400, 480, 600, 800, 1200, 1600, 2400, 4800

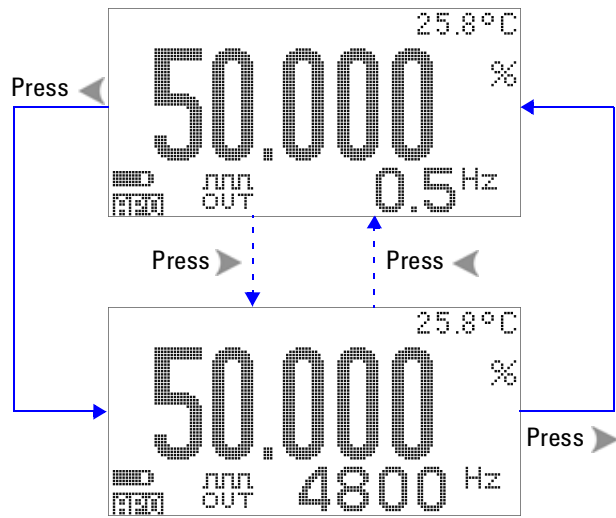





Figure 3-12 Frequency adjustment for square wave output

Selecting square wave output duty cycle

- 1 Set the rotary switch to  %
OUT ms.
- 2 Press  to select duty cycle (%) on the primary display.
- 3 Press  or  to adjust the duty cycle. The duty cycle can be stepped through 256 steps, with each step equivalent to 0.390625%. The best resolution the display can offer is 0.001%.

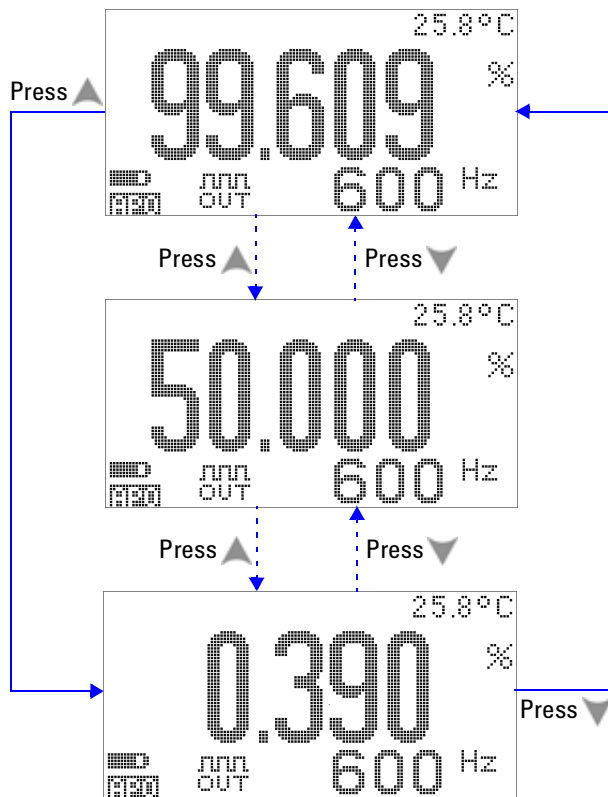





Figure 3-13 Duty cycle adjustment for square wave output

Selecting square wave output pulse width

- 1 Set the rotary switch to  %
OUT ms.
- 2 Press  to select pulse width (ms) on the primary display.
- 3 Press  or  to adjust the pulse width. The pulse width can be stepped through 256 steps, with each step equivalent to $1/(256 \times \text{frequency})$. The displayed pulse width will be automatically adjusted to 5 digits (ranging from 9.9999 to 9999.9 ms).

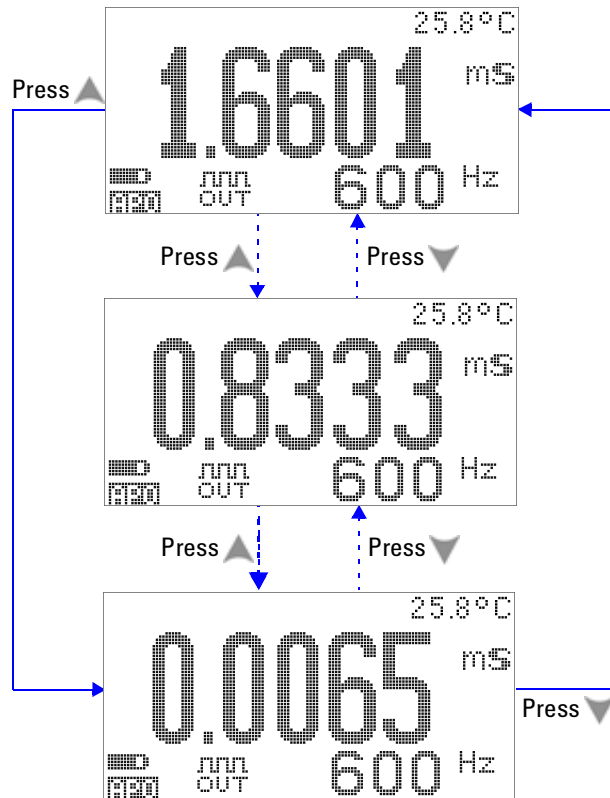

Figure 3-14 Pulse width adjustment for square wave output

Remote Communication

This multimeter has a bidirectional (full duplex) communication capability that enables data transfer from the multimeter to a PC. The required accessory for this is an optional IR-USB cable, to be used with an application software that is downloadable from the Agilent Web site.

For details on performing PC-multimeter remote communication, click on Help after launching the Agilent GUI Data Logger software.

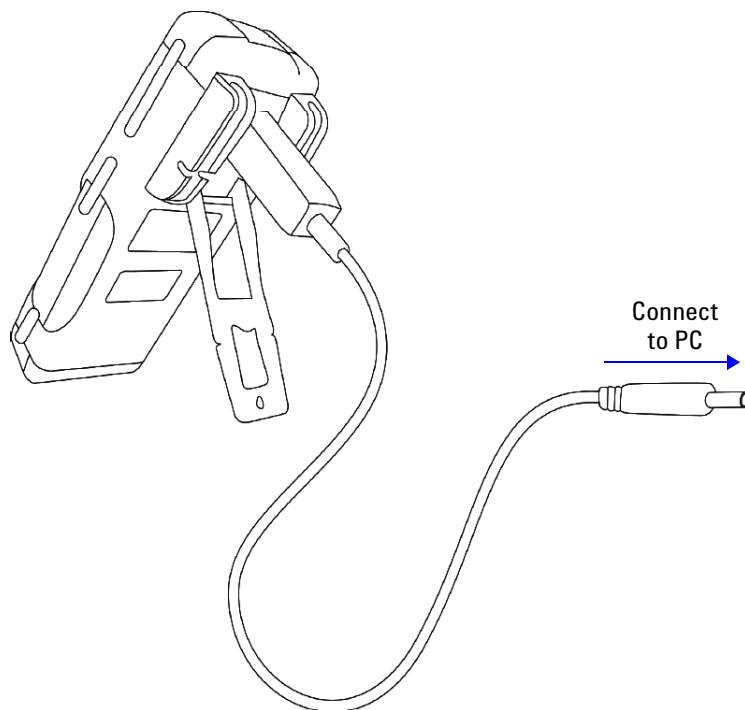
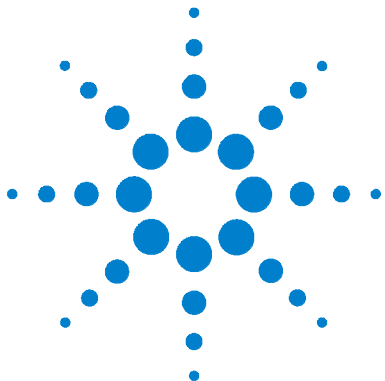

Figure 3-15 Cable connection for remote communication

3 Functions and Features



4 Changing the Default Settings

Selecting Setup Mode	84
Default Factory Settings and Available Setting Options	85
Setting Data Hold/Refresh Hold mode	89
Setting data logging mode	90
Setting dB measurement	92
Setting reference impedance for dBm measurement	93
Setting thermocouple types	94
Setting temperature unit	94
Setting percentage scale readout	96
Setting minimum measurable frequency	98
Setting beep frequency	99
Setting Auto Power Off mode	100
Setting power-on backlight brightness level	102
Setting the power-on melody	103
Setting the power-on greeting screen	104
Setting baud rate	105
Setting parity check	106
Setting data bits	107
Setting echo mode	108
Setting print mode	109
Revision	110
Serial number	110
Voltage alert	111
M-initial	112
Smooth refresh rate	116
Returning to default factory settings	117
Setting the battery type	118
Setting the DC filter	119













This chapter describes how to change the default factory settings of the U1253B true RMS OLED multimeter and other available setting options.



Selecting Setup Mode

To enter Setup mode, press and hold  for more than 1 second.

To change a menu item setting in Setup mode, perform the following steps:

- 1 Press  or  to view the selected menu pages.
- 2 Press  or  to navigate to the item that needs to be changed.
- 3 Press  to enter the **EDIT** mode for adjusting the item you want to change. When you are in the **EDIT** mode:
 - i Press  or  to select which digit to adjust.
 - ii Press  or  to adjust the value.
 - iii Press  to exit **EDIT** mode without saving the changes.
 - iv Press  to save the changes you have made and exit the **EDIT** mode.
- 4 Press  for more than 1 second to exit Setup mode.

Default Factory Settings and Available Setting Options

The following table shows the various menu items with their respective default settings and available options.

Table 4-1 Default factory settings and available setting options for each feature

Menu	Feature	Default factory setting	Available setting options
1	RHOLD	500	Refresh hold. <ul style="list-style-type: none"> To enable this function, select a value within the range of 100 to 9900. To disable this function, set all digits to zero ("OFF" will be indicated). Note: Select OFF to enable data hold (manual trigger).
	D-LOG	HAND	Available options for data logging: <ul style="list-style-type: none"> HAND: manual data logging. TIME: interval (automatic) data logging, where the interval is according to the LOG TIME setting.
	LOG TIME	0001 S	Logging interval for interval (time) data logging. Select a value within the range of 0001 second to 9999 seconds.
	dB	dBm	<ul style="list-style-type: none"> Available options: dBm, dBV, or OFF. Select OFF to disable this function for normal operation.
	dBm-R	50 Ω	Reference impedance value for dBm measurement. Select a value within the range of 1 Ω to 9999 Ω .

4 Changing the Default Settings

Table 4-1 Default factory settings and available setting options for each feature



Menu	Feature	Default factory setting	Available setting options
2	T-TYPE	K	Thermocouple type. • Available options: K-type or J-type
	T-UNIT	°C	Temperature unit. • Available options: <ul style="list-style-type: none"> ◦ °C/°F: Dual display, °C in primary display, °F in secondary. ◦ °C: Single display, in °C only. ◦ °F/°C: Dual display, °F in primary display, °C in secondary. ◦ °F: Single display, in °F only. • Press  to swap between °C and °F.
	mA-SCALE	4 mA to 20 mA	Percentage scale for mA. • Available options: 4 – 20 mA, 0 – 20 mA, or OFF. • Select OFF to disable this function for normal operation.
	CONTINUITY	SINGLE	Audible continuity. • Available options: SINGLE, OFF or TONE.
	MIN-Hz	0.5 Hz	Minimum measurement frequency. Available options: 0.5 Hz, 1 Hz, 2 Hz, or 5 Hz.
3	BEEP	2400	Beep frequency. • Available options: 4800 Hz, 2400 Hz, 1200 Hz, 600 Hz, or OFF. • To disable this function, select OFF.
	APO	10 M	Automatic power off. • To enable this function, select a value within the range of 1 minute to 99 minutes. • To disable this function, set all digits to zero (“OFF” will be indicated).
	BACKLIT	HIGH	Default power-on backlight brightness level. Available options: HIGH, MEDIUM, or LOW.
	MELODY	FACTORY	Power-on melody. Available options: FACTORY, USER or OFF.
	GREETING	FACTORY	Power-on greeting. Available options: FACTORY, USER or OFF.

Table 4-1 Default factory settings and available setting options for each feature

Menu	Feature	Default factory setting	Available setting options
4	BAUD	9600	Baud rate for remote communication with a PC (remote control). Available options: 2400, 4800, 9600, and 19200.
	DATA BIT	8	Data bit length for remote communication with a PC. Available options: 8 bits or 7 bits (stop bit is always 1 bit).
	PARITY	NONE	Parity bit for remote communication with a PC. Available options: NONE, ODD, or EVEN.
	ECHO	OFF	Return of characters to PC in remote communication. Available options: ON or OFF.
	PRINT	OFF	Prints measured data to a PC in remote communication. Available options: ON or OFF.
5	REVISION	NN.NN	Revision number. Editing is disabled.
	S/N	NNNNNNNN	The last 8 digits of the serial number will be indicated. Editing is disabled.
	V-ALERT	OFF	Audible alert tone for voltage measurement. <ul style="list-style-type: none"> To enable this function, select an overvoltage value within the range of 1 V to 1010 V. To disable this function, set all digits to zero ("OFF" will be indicated).
	M-INITIAL	FACTORY	Initial measurement functions. Available options: FACTORY or USER.
	SMOOTH	NORMAL	Refresh rate for primary display readings. Available options: FAST, NORMAL, or SLOW.
6	DEFAULT	NO	Select YES, then press  for longer than 1 second to reset the multimeter to its default factory settings.
	BATTERY	7.2 V	Battery type used for the multimeter. Available options: 7.2 V or 8.4 V.
	DC FILTER	OFF	Filter for DC voltage or DC current measurement. Available options: OFF or ON.

4 Changing the Default Settings

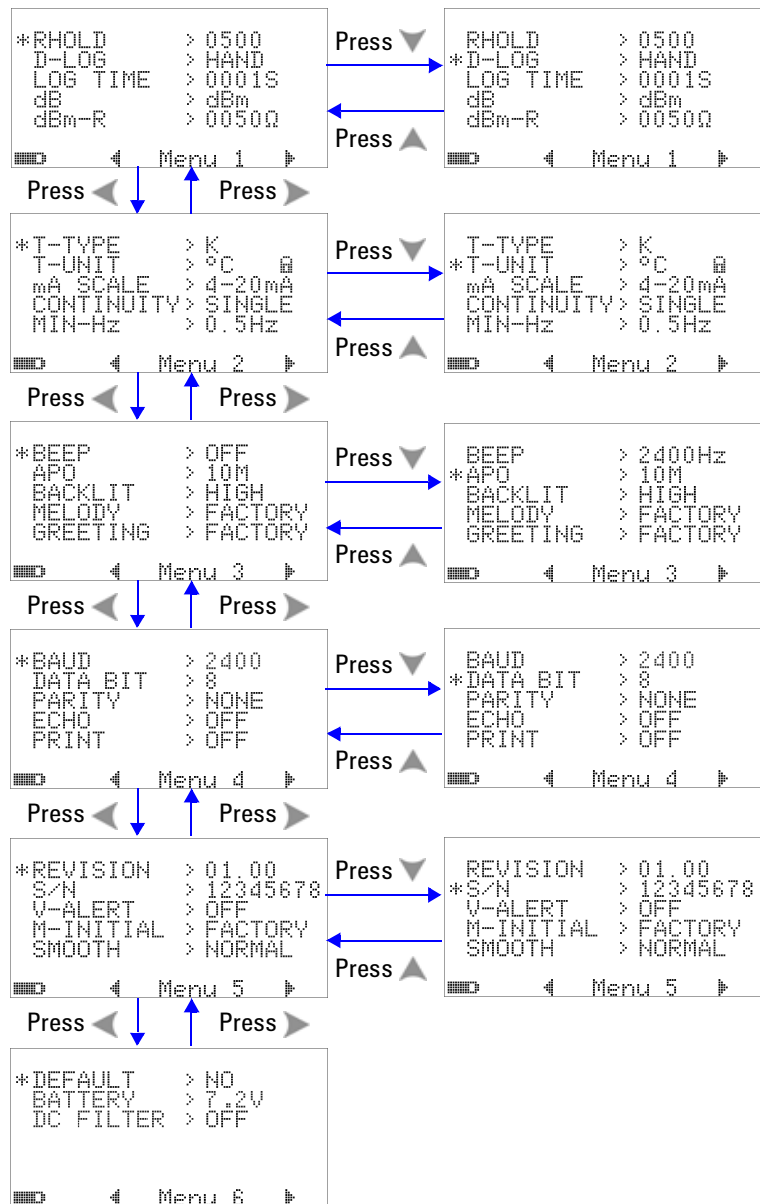

Figure 4-1 Setup menu screens

Setting Data Hold/Refresh Hold mode

- 1 Set menu item RHOLD to “OFF” to enable Data Hold mode (manual trigger by key or bus via remote control).
- 2 Set menu item RHOLD within the range of 100 to 9900 to enable Refresh Hold mode (automatic trigger). Once the variation of measured values exceeds this value (which is the variation count), the Refresh Hold will be ready to trigger and hold a new value.

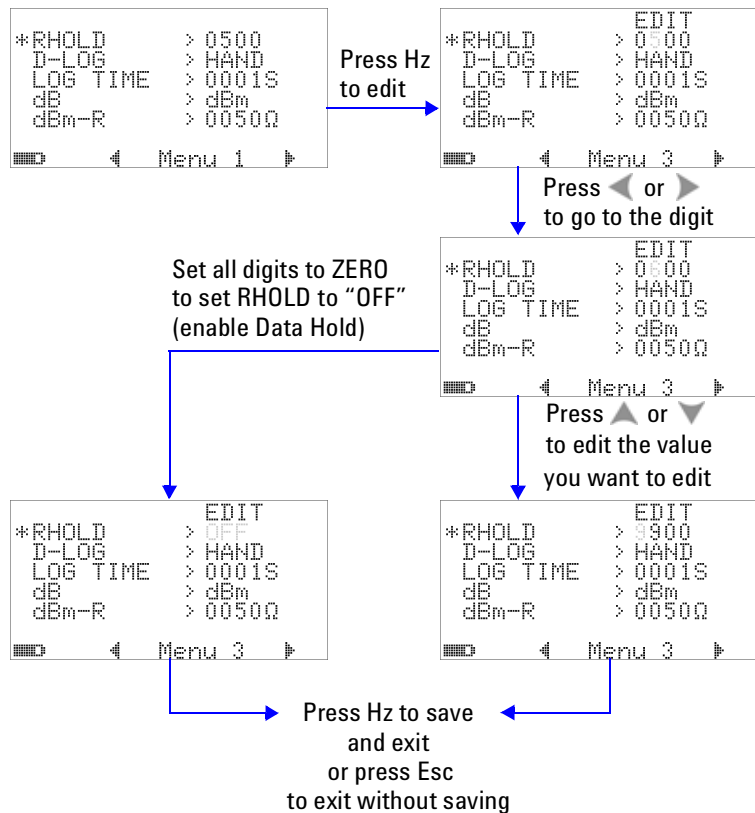

Figure 4-2 Data Hold/Refresh Hold setup

Setting data logging mode

- 1 Set to “HAND” to enable manual (hand) data logging, or set to “TIME” to enable interval (time) data logging. Refer to [Figure 4-3](#) on page 90.

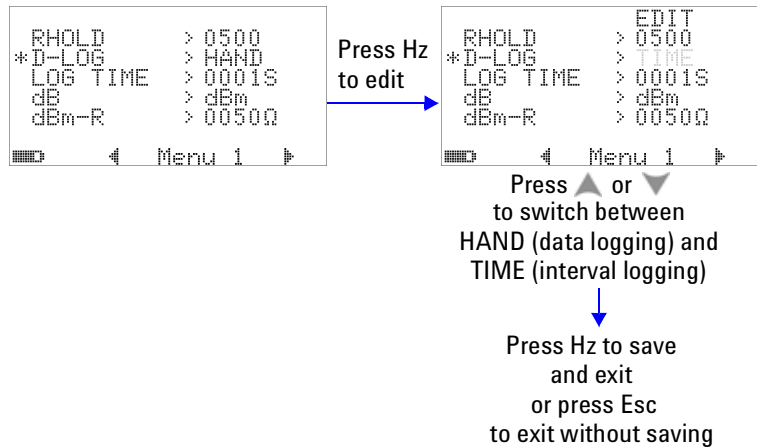

Figure 4-3 Data logging setup

- 2 For interval (time) data logging, set the LOG TIME within the range of 0001 second to 9999 seconds to specify the data logging interval.

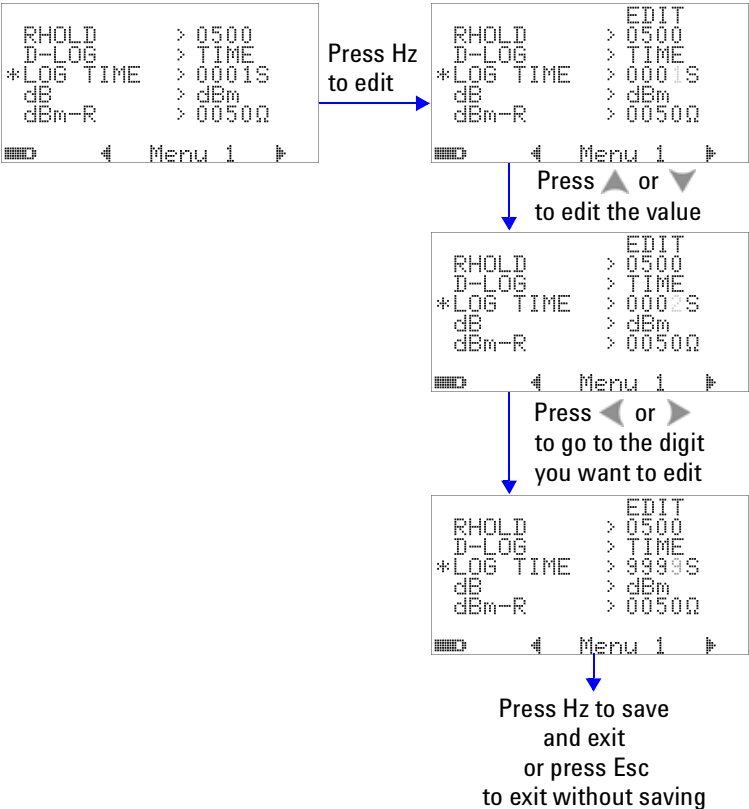

Figure 4-4 Log time setup for interval (time) logging

Setting dB measurement

The decibel unit can be disabled by setting this to “OFF”. The available options are dBm, dBV, and OFF. For dBm measurement, the reference impedance can be set by the “dBm-R” menu item.

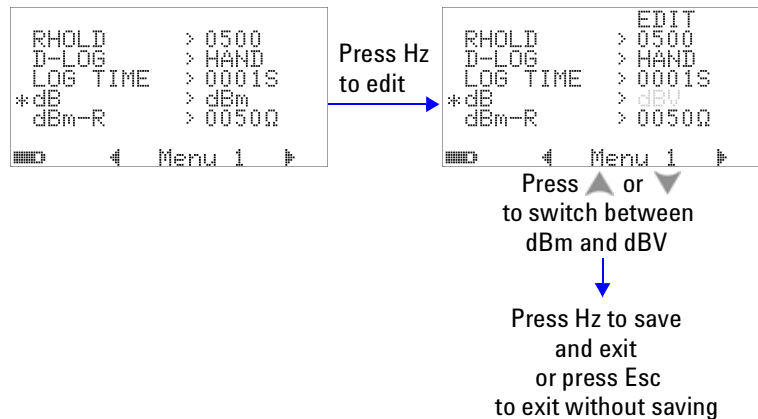

Figure 4-5 Decibel measurement setup

Setting reference impedance for dBm measurement

The reference impedance for dBm measurement can be set to any value within the range of 1 to 9999 Ω . The default value is 50 Ω .

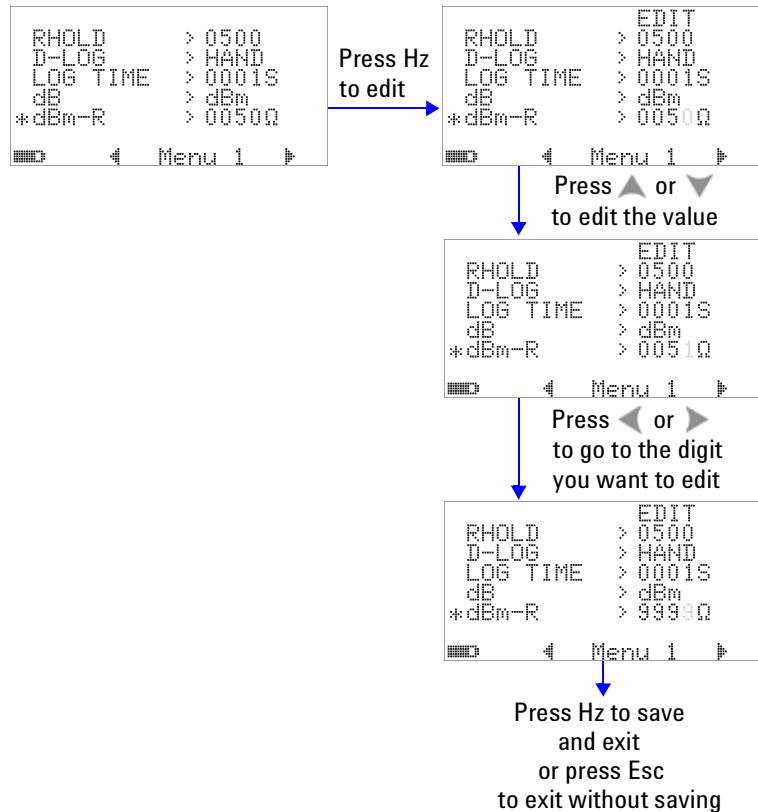

Figure 4-6 Setting up the reference impedance for dBm unit

Setting thermocouple types

The types of thermocouple sensor that can be selected are J-type and K-type. The default type is K-type.

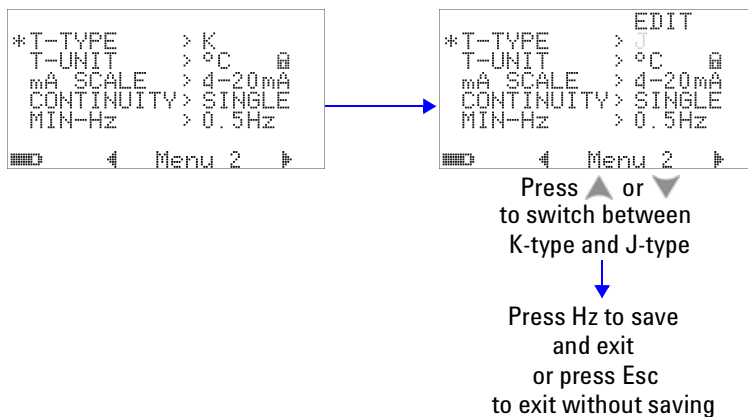

Figure 4-7 Thermocouple type setup

Setting temperature unit

The temperature unit setting at power on

Four combinations of displayed unit(s) are available:

- 1 Celsius only: °C single display.
- 2 Celsius/Fahrenheit: °C/°F dual display; °C on primary, and °F on secondary.
- 3 Fahrenheit only: °F single display.
- 4 Fahrenheit/Celsius: °F/°C dual display; °F on primary, and °C on secondary.

NOTE

The temperature unit setting at power on is locked by default and thus temperature unit editing is not allowed unless it is unlocked.

Press  to unlock the temperature unit setting and the lock sign will be removed.

Press  again to lock the temperature unit setting.

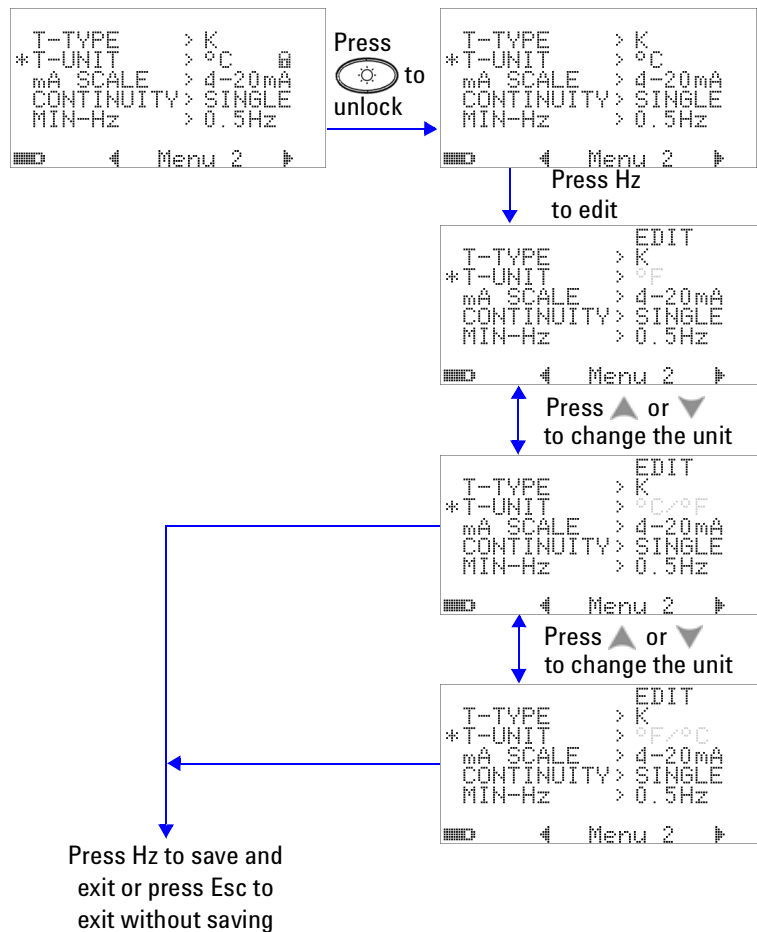

Figure 4-8 Temperature unit setup

Setting percentage scale readout

This setting converts the DC current measurement display to percentage scale readout: 0% to 100% based on a range of 4 mA to 20 mA or 0 mA to 20 mA. For example, a 25% readout represents a DC current of 8 mA for the 4 mA to 20 mA range, or a DC current of 5 mA for the 0 mA to 20 mA range. To disable this function, set this to “OFF”.

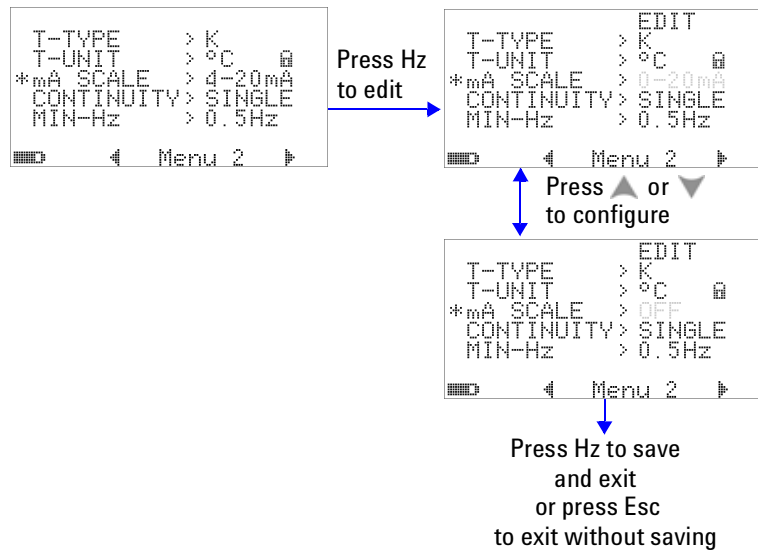

Figure 4-9 Setting up percentage scale readout

Sound setting for continuity test

This setting determines the sound used in the continuity test. Select "SINGLE" for a single-frequency beep, select "OFF" for a silent beep, or select "TONE" for a continuous string of beeps with varying frequencies.

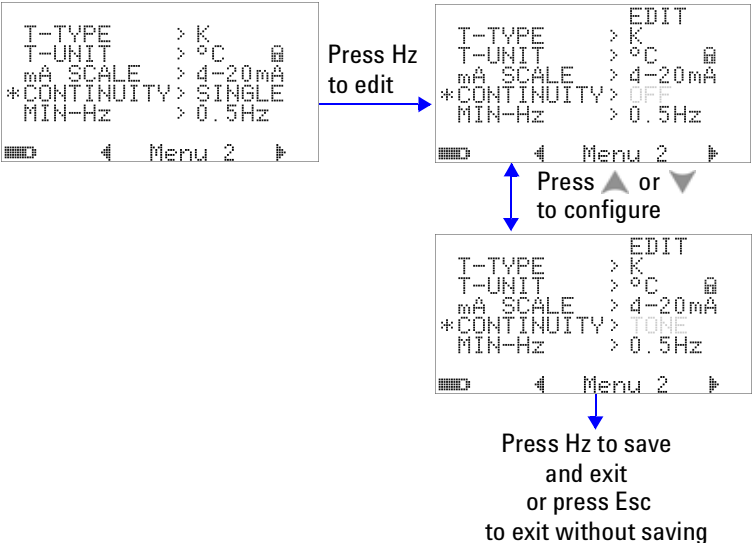

Figure 4-10 Choosing the sound used in continuity test

Setting beep frequency

The beep frequency can be set to 4800 Hz, 2400 Hz, 1200 Hz, or 600 Hz. “OFF” means the beep sound is disabled.

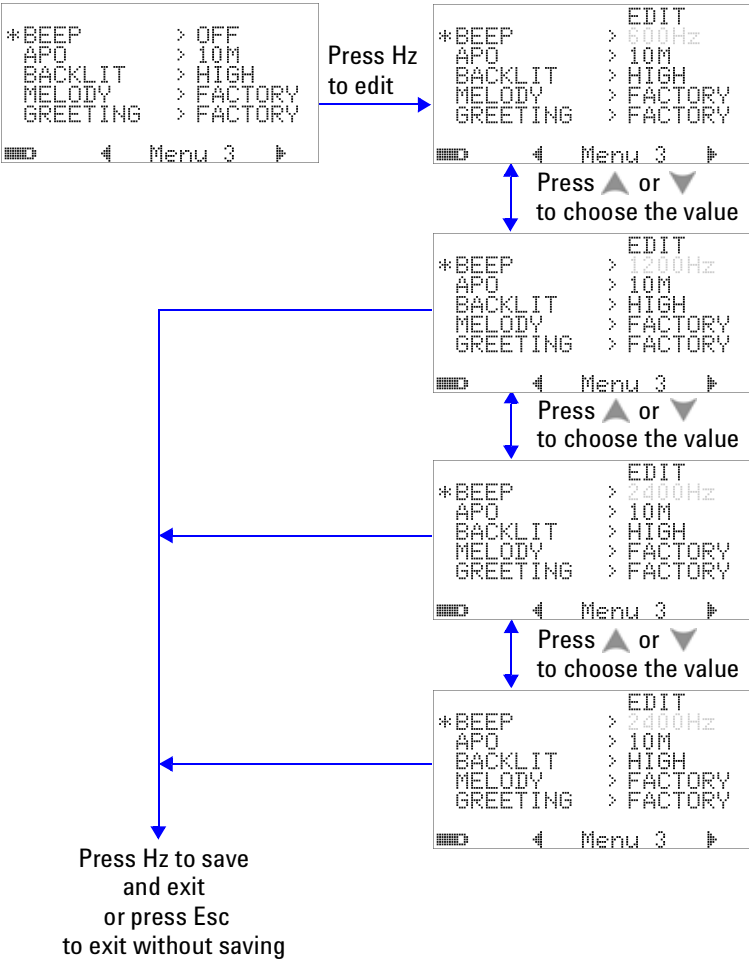



Figure 4-12 Beep frequency setup

Setting Auto Power Off mode

- To enable APO (Auto Power Off), set its timer to any value within the range of 1 to 99 minutes.
- The instrument may turn off automatically (with APO enabled) after the specified amount of time, if none of the following happens within that time:
 - A measurement is taken.
 - Any push-button is pressed.
 - A measurement function is changed.
 - Dynamic recording is set.
 - 1 ms peak hold is set.
 - APO is disabled in the Setup mode.
- To reactivate the multimeter after auto power off, simply press any button or change the rotary switch position.
- To disable APO, select OFF. When APO is disabled, the  annunciator will be turned off. The multimeter will remain on until you manually turn the rotary switch to the OFF position.

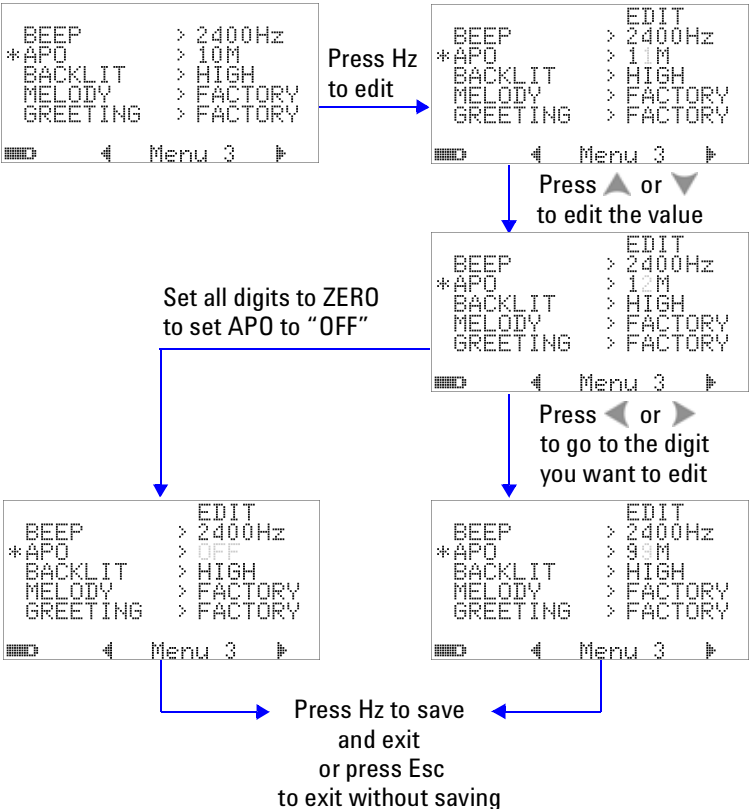

Figure 4-13 Automatic power saving setup

Setting power-on backlight brightness level

The brightness level that is displayed when the multimeter turns on can be set to HIGH, MEDIUM, or LOW.

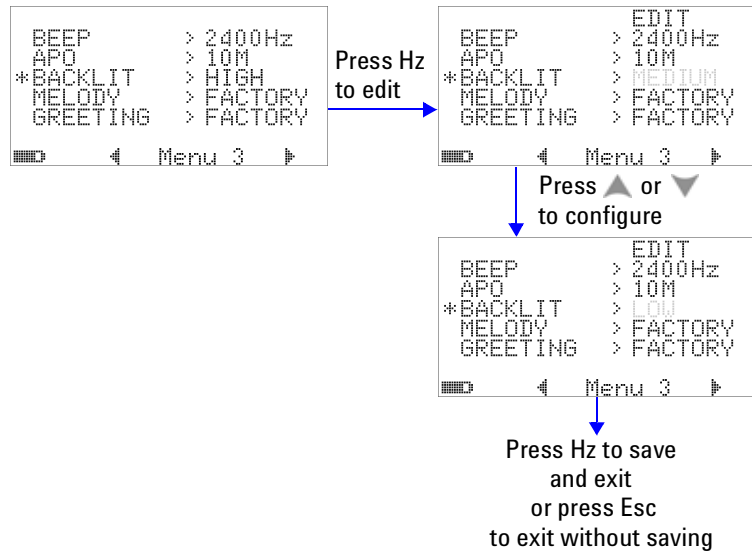



Figure 4-14 Power-on backlight setup

While using the multimeter, you may adjust the brightness at any time by pressing the  button.

Setting the power-on melody

The melody that is played when the multimeter turns on can be set to FACTORY, USER or turned OFF.

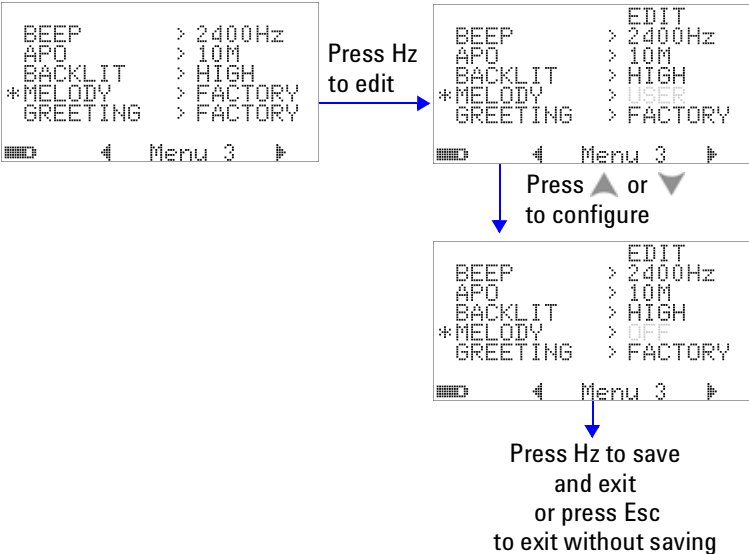

Figure 4-15 Power-on melody setup

Setting baud rate

The baud rate used in the remote communication with a PC can be set as 2400, 4800, 9600, or 19200 bits/second.

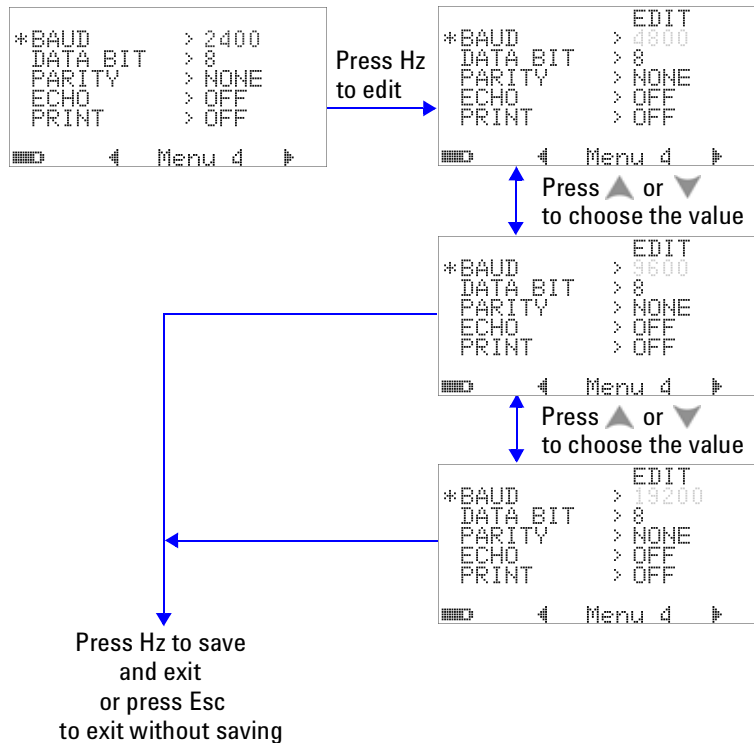

Figure 4-17 Baud rate setup for remote control

Setting parity check

The parity check for remote communication with a PC can be set to either NONE, ODD, or EVEN.

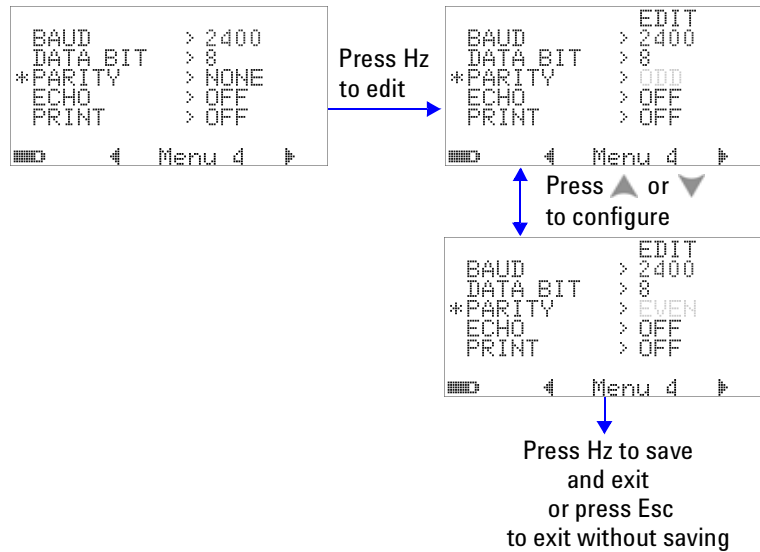

Figure 4-18 Parity check setup for remote control

Setting data bits

The number of data bits (data width) for remote communication with a PC can be set to either 8 or 7 bits. The number of stop bit is always 1, and this cannot be changed.

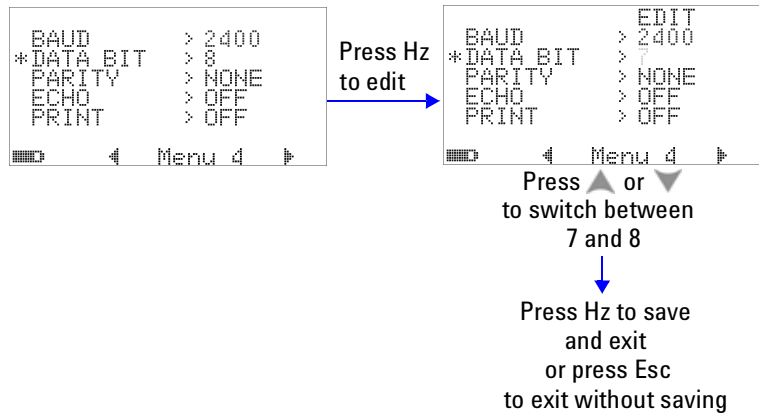

Figure 4-19 Data bits setup for remote control

Setting echo mode

- Setting this feature “ON” enables the transmitted characters to be echoed on the PC in remote communication.
- This is useful when developing PC program with SCPI commands. During normal operation, it is recommended that you disable this function.

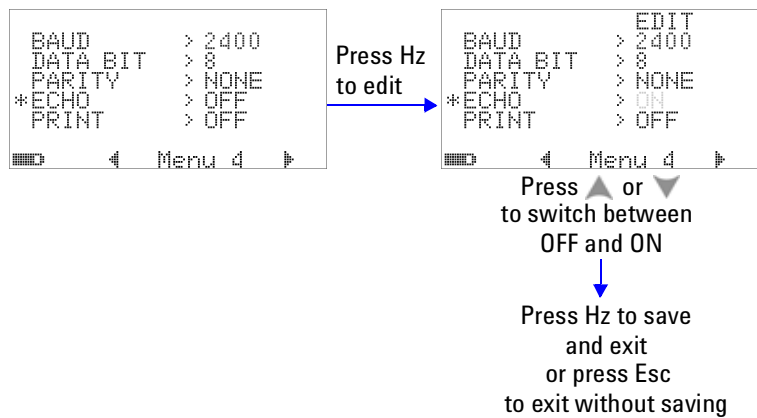



Figure 4-20 Echo mode setup for remote control

Setting print mode

Setting this feature “ON” enables printout of measured data to a PC that is connected to the multimeter via the remote interface when a measurement cycle is completed.

In this mode, the multimeter continuously sends the latest data to the host, but does not accept any commands from the host.

The  indicator flashes during print operation.

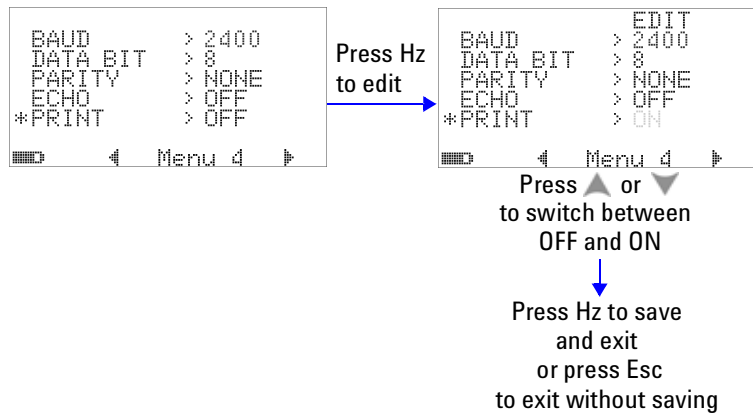

Figure 4-21 Print mode setup for remote control

Revision

The revision number of the firmware will be indicated.

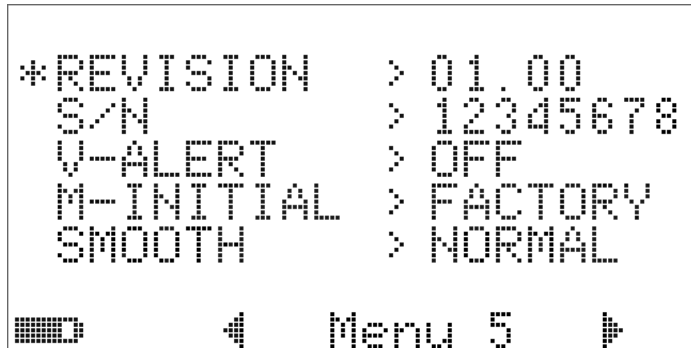

Figure 4-22 Revision number

Serial number

The last 8 digits of the serial number will be indicated.



Figure 4-23 Serial number

Voltage alert

To enable an alert tone for overvoltage, select an overvoltage value within the range of 1 V to 1010 V.

To disable this function, set all digits to 0 (“OFF”).

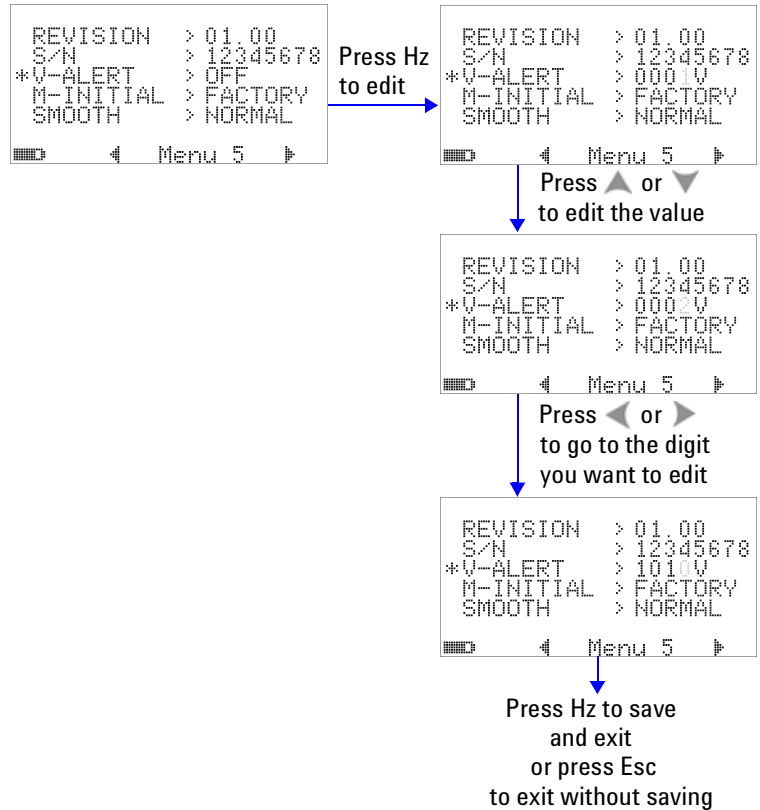











Figure 4-24 Voltage alert setup



M-initial

You may select the initial measurement functions as **FACTORY** or **USER**. The initial measurement functions and range can be set according to [Table 4-2](#) below.

Table 4-2 Available settings for M-initial

Function position	Function setting	Range setting	
F1	 V	AC V	Auto or manual ranges
F2	 V	DC V, AC V, AC+DC V	Auto or manual ranges
F3	 mV	DC mV, AC mV, AC+DC mV	Auto or manual ranges
F4	 nS Ω	Ohm, nS	Auto or manual ranges
F5	 Hz →	Diode, frequency counter	Auto or manual ranges
F6	 →	Temperature, capacitance	Auto or manual ranges
F7	 μA	DC μA, AC μA, AC+DC μA	Auto or manual ranges
F8	 mA	DC mA, AC mA, AC+DC mA	Auto or manual ranges
F8A	 mA	DC A, AC A, AC+DC A	Auto or manual ranges
F9	 % OUT ms	29 different frequencies	Duty cycle = $(N/256) \times 100\%$ Pulse width = $(N/256) \times (1/\text{frequency})$

Each rotary switch position is assigned a default measurement function and a default measurement range.

As example, when you turn the rotary switch to the  position, the initial measurement function is diode measurement, according to the default factory setting. In order to choose the frequency counter function, you have to press the  button.

For another example, when you turn the rotary switch to the $\sim V$ position, the initial measurement range is Auto, according to default factory setting. In order to choose a different range, you will have to press the **Range** button.

If you prefer to have a different set of initial measurement functions, change the M-INITIAL setting to USER, and press the **Hz** button. The multimeter will then enter the **INIT** pages. Please refer to [Figure 4-25](#).

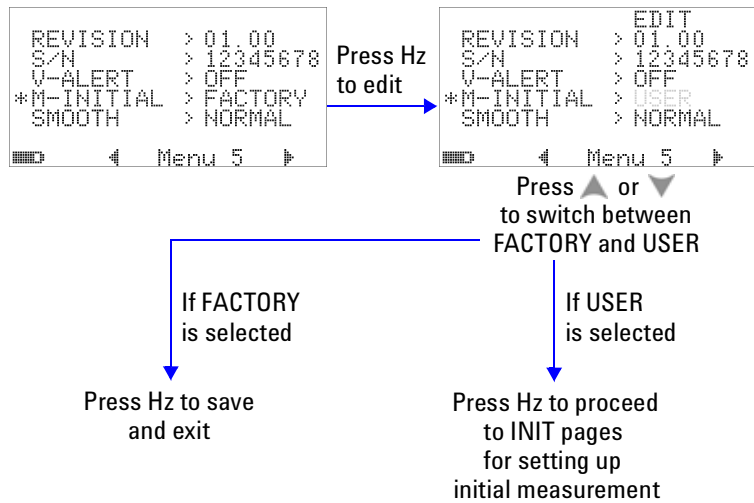

Figure 4-25 Setting initial measurement functions

In the **INIT** pages, you may define your preferred initial measurement functions. Please refer to [Figure 4-26](#).

Press \leftarrow or \rightarrow to navigate between the two INIT pages.
 Press \blacktriangle or \blacktriangledown to choose which initial function you want to change.

4 Changing the Default Settings

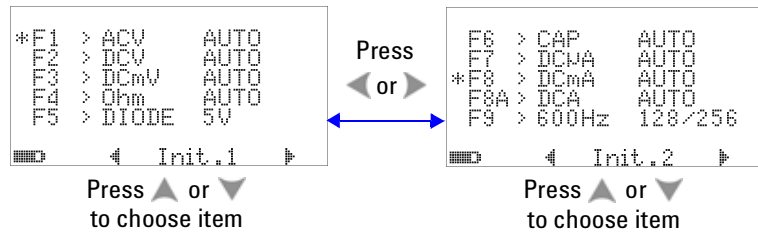

Figure 4-26 Navigating between the initial functions pages

Then press $\textcircled{\text{Hz}}$ to enter the **EDIT** mode.

In the **EDIT** mode, press \leftarrow or \rightarrow to change the initial (default) measurement range of a selected function. For example, [Figure 4-27](#) below shows the initial range of the AC voltage measurement function at the F1 position changed to 1000 V (default was Auto).

Press \uparrow or \downarrow to change the initial measurement function of a selected rotary switch position. For example, [Figure 4-27](#) below shows the initial measurement function of the F5 position changed from DIODE to FC (frequency counter).

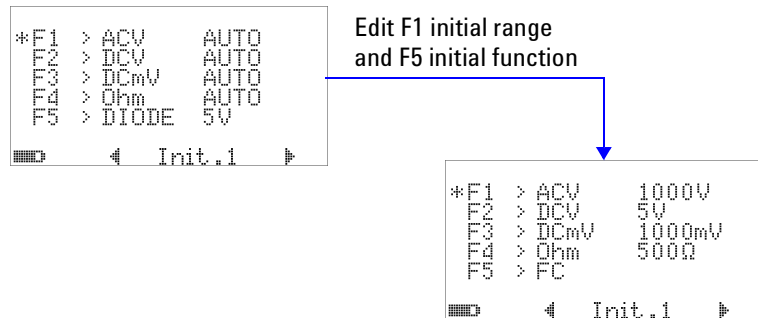

Figure 4-27 Editing initial measurement function/range

As another example, [Figure 4-28](#) below illustrates that:

- The F6 default function is changed from capacitance measurement to temperature measurement;

- The F7 default measurement range for DC μ A is changed from Auto to 5000 μ A;
- The F8 default measurement range for DC mA is changed from Auto to 50 mA;
- The F8A default measurement range for DC A is changed from Auto to 5 A;
- The F9 default output values for pulse width and duty cycle are both changed from the 128th step (0.8333 ms for pulse width and 50.000% for duty cycle) to the 255th step (1.6601 ms for pulse width and 99.609%).

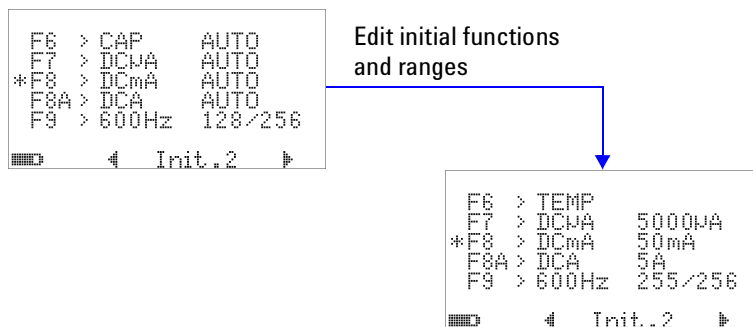

Figure 4-28 Editing initial measurement function/range and initial output values

After making the desired changes, press **Hz** to save the changes. Press **Shift** exit the **EDIT** mode.

If you reset the multimeter to its default factory settings (see “[Returning to default factory settings](#)” on page 117), your settings for M-INITIAL will also revert to the factory defaults.

Smooth refresh rate

The SMOOTH mode (with a choice of FAST, NORMAL, or SLOW) is used to smoothen the refresh rate of the readings, in order to reduce the impact of unexpected noise and to help you get a stable reading. It applies to all measurement functions except capacitance and frequency counter (including duty cycle and pulse width measurements). The default is NORMAL.

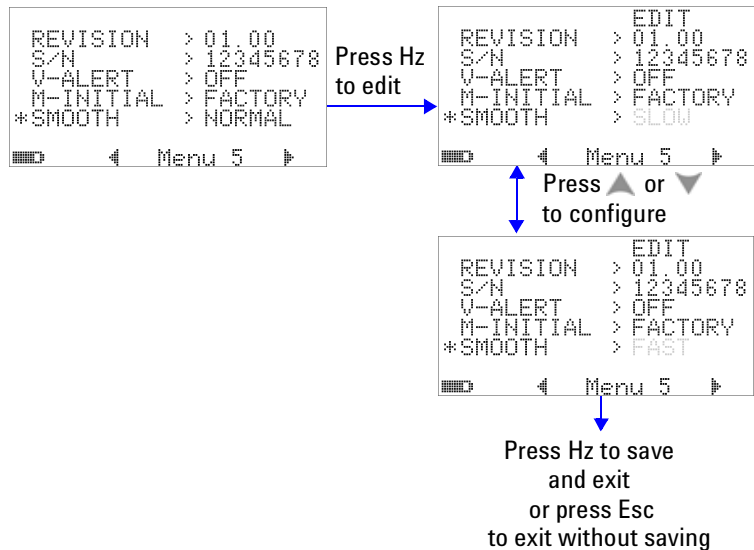

Figure 4-29 Refresh rate for primary display readings

Returning to default factory settings

- Set to “YES”, then press  for more than 1 second to reset to default factory settings (all except the temperature setting).
- The Reset menu item automatically reverts to menu page m1 after a reset has taken place.



Figure 4-30 Resetting to default factory settings

Setting the battery type

The battery type for the multimeter can be set to either 7.2 V or 8.4 V.

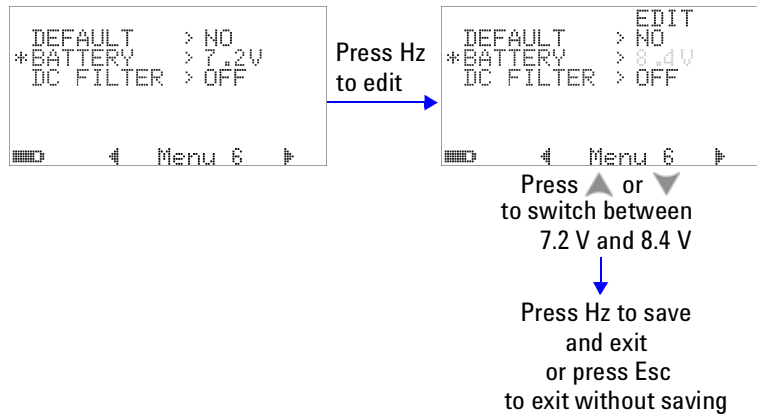

Figure 4-31 Battery type selection

Setting the DC filter

This setting is used to filter AC signal in DC measuring path. The DC filter is set to “OFF” by default. To enable this function, set this to “ON”.

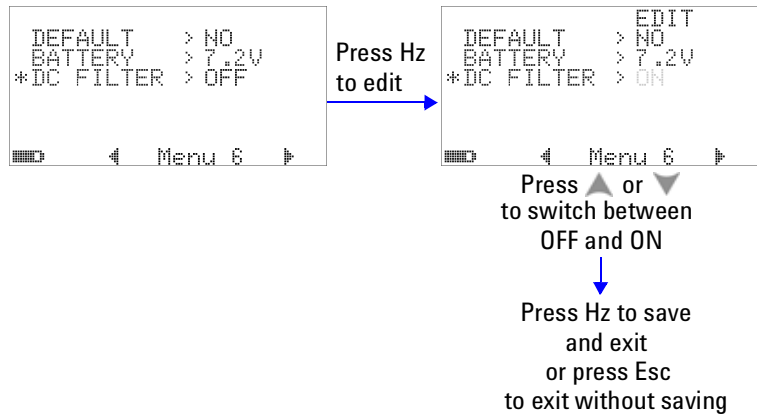
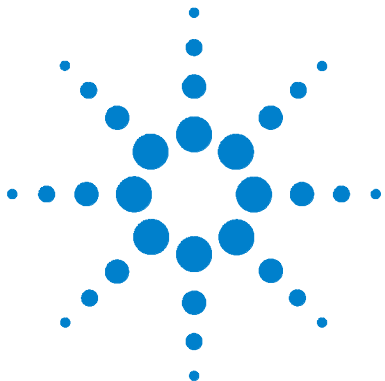

Figure 4-32 DC filter

NOTE

- When DC filter is enabled, the measurement speed may decrease during DC voltage measurement.
- During AC or Hz measurement (on primary or secondary display), DC filter will be automatically disabled.

4 Changing the Default Settings



5 Maintenance

Introduction	122
General maintenance	122
Battery replacement	123
Charging battery	125
Fuse replacement	132
Troubleshooting	134

This chapter will help you troubleshoot a malfunctioning U1253B true RMS OLED multimeter.



Introduction

CAUTION

Any repair or service which is not covered in this manual should only be performed by qualified personnel.

General maintenance

WARNING

Ensure that terminal connections are correct for a particular measurement before making the measurement. To avoid damaging the device, do not exceed the rated input limit.

Dirt or moisture in the terminals can distort readings. Cleaning procedures are as follows:

- 1 Turn the multimeter off and remove the test leads.
- 2 Turn the multimeter over and shake out any dirt that may have accumulated in the terminals.
- 3 Wipe the case with a damp cloth and mild detergent – do not use abrasives or solvents. Wipe the contacts in each terminal with a clean cotton swab moistened with alcohol.

Battery replacement

WARNING

Do not discharge the battery by shorting it or subjecting it to reverse polarity. Make sure a battery is rechargeable before charging it. Do not rotate the rotary switch when the battery is being charged.

This multimeter is powered by a 7.2 V or 8.4 V NiMH rechargeable battery which must be the specified battery type. Alternatively you may also use a 9 V Alkaline battery (ANSI/NEDA 1604A or IEC 6LR61) or a 9 V Carbon-zinc battery (ANSI/NEDA 1604D or IEC6F22) to power the U1253B. To ensure that the multimeter performs as specified, it is recommended that you replace the battery as soon as the low-battery indicator is displayed flashing. If your multimeter has a rechargeable battery inside, please go to [“Charging battery”](#) on page 125. The procedures for battery replacement are as follows:

NOTE

The 7.2 V or 8.4 V NiMH rechargeable battery is supplied along with the U1253B.

- 1 On the rear panel, turn the screw on the battery cover counterclockwise from the LOCK position to OPEN.

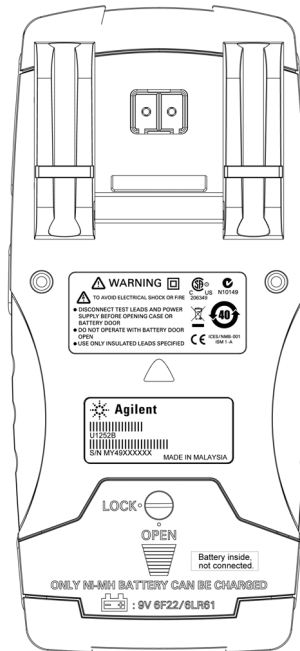

Figure 5-1 Rear panel of the Agilent U1253B True RMS OLED Multimeter

- 2 Slide the battery cover down.
- 3 Lift the battery cover up.
- 4 Replace with the specified battery.
- 5 Reverse the procedures of opening the cover to close it.

Charging battery

WARNING

Do not discharge the battery by shorting it or subjecting it to reverse polarity. Make sure a battery is rechargeable before charging it. Do not rotate the rotary switch when the battery is being charged.

CAUTION

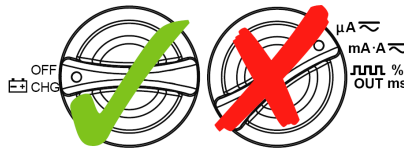

- Do not rotate the rotary switch from OFF CHG position when charging the battery.
- Perform battery charging only with 7.2 V or 8.4 V NiMH rechargeable battery, 9 V size.
- Disconnect test leads from all the terminals when charging the battery.
- Ensure proper insertion of battery in the multimeter, and follow the correct polarity.

NOTE

For the battery charger, the mains supply voltage fluctuations must not exceed $\pm 10\%$.

This multimeter is powered by a 7.2 V or 8.4 V NiMH rechargeable battery. It is strongly recommended that you use the specified 24-volt DC adapter included as an accessory to charge the rechargeable battery. Never rotate the rotary switch while the battery is being charged because a DC voltage of 24 V is applied to the charging terminals. Follow the procedures below to charge the battery:

- 1 Remove the test leads from the multimeter.
- 2 Turn the rotary switch to OFF CHG .
- 3 Plug the DC adapter into a power outlet.

- 4 Insert the red (+) and black (-) banana plugs (4 mm plugs) of the DC adapter to the **CHG** and **COM** terminals respectively. Ensure that the polarity of the connection is correct.

NOTE

The DC adapter can be replaced with a DC power supply set at DC 24 V with an overcurrent limit of 0.5 A.

- 5 The display will show a countdown timer of 10 seconds for the self-test to start. The multimeter will output short single-tone sounds to remind you to charge the battery. Press **Shift** to start charging the battery, or the multimeter will automatically start charging after 10 seconds. It is recommended not to charge the battery if the battery capacity is over 90%.



Figure 5-2 Self-testing time display

Table 5-1 Battery voltage and corresponding percentage of charges in standby and charging modes

Condition	Battery voltage	Proportional percentage
Trickle	6.0 V to 8.2 V	0% to 100%
Being charged up	7.2 V to 10.0 V	0% to 100%

- After pressing  or in the case of a restart, the multimeter will perform a self-test to check whether the battery inside the multimeter is a rechargeable battery. This self-test will take 3 minutes. Avoid pressing any of the push-buttons during the self-test. If there is any error, the multimeter will display error messages as shown in [Table 5-2](#) on page 128.



Figure 5-3 Performing self-test

Table 5-2 Error messages

Error	Error message
<p>OVER LIMIT</p> <ol style="list-style-type: none"> 1 No battery inside 2 Faulty battery 3 Battery is fully charged 	 <p>The screenshot shows a monochrome LCD display. At the top, the text 'OVER LIMIT' is displayed. Below it, a large digital timer shows '00:00:19'. At the bottom, there is a battery level indicator consisting of a battery icon, a scale from 0 to 8, and the text '100%'. Below the scale, there are eight vertical bars of varying heights representing the charge level.</p>
<p>CHARGE ERROR</p> <ol style="list-style-type: none"> 1 Non-rechargeable battery inside 2 Faulty battery 	 <p>The screenshot shows a monochrome LCD display. At the top, the text 'CHARGE ERROR' is displayed. Below it, a large digital timer shows '00:02:59'. At the bottom, there is a battery level indicator consisting of a battery icon, a scale from 0 to 8, and the text '100%'. Below the scale, there are eight vertical bars of varying heights representing the charge level.</p>

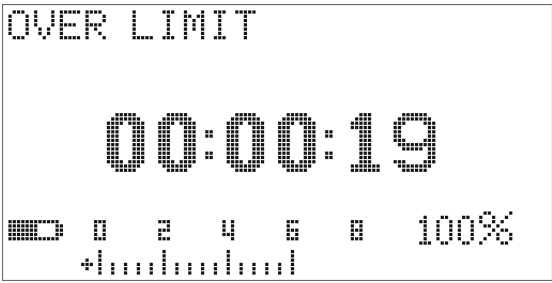
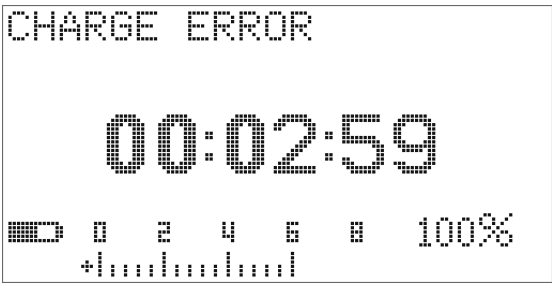
NOTE

- If the **OVER LIMIT** message is displayed, and there is a battery inside the multimeter, please do not charge the battery.
- If the **CHARGE ERROR** message is displayed, check whether the battery is the specified type. The correct battery type is specified in this guide. Please ensure that the battery in the multimeter is the specified type of rechargeable battery before charging it. After replacing any wrong battery with the correct specified type of rechargeable battery, press  to redo the self-test. Replace with a new battery if the **CHARGE ERROR** message is again displayed.

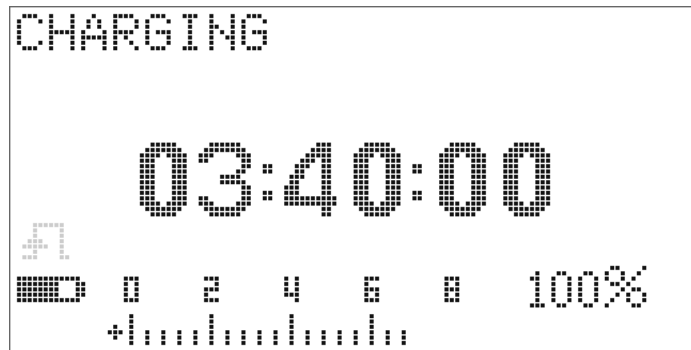

Figure 5-4 Charging mode

- 7 The smart charging mode will start if the battery passes the self-test. The charging time is limited to within 220 minutes. This ensures that the battery will not be charged for more than 220 minutes. The display will count down the charging time. When battery charging is in progress, none of the push-buttons can be operated. To avoid overcharging the battery, the charging may be stopped with an error message during the charging process.

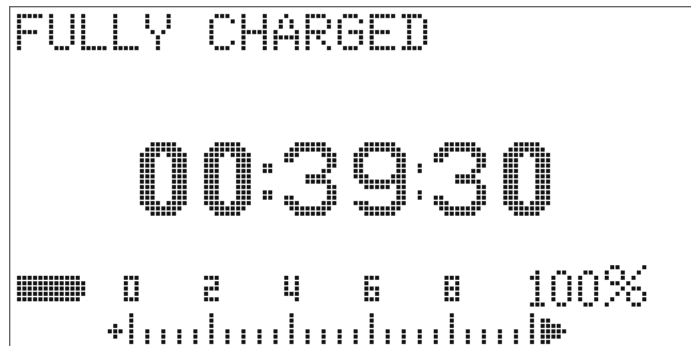

Figure 5-5 Fully charged and in the trickle state

- 8 Once the charging is completed, the **FULLY CHARGED** message will be displayed. A trickle charging current will be drawn to maintain the battery capacity.
- 9 Remove the DC adapter when the battery has been fully charged.

CAUTION

Do not turn the rotary switch before removing the adapter from the terminals.

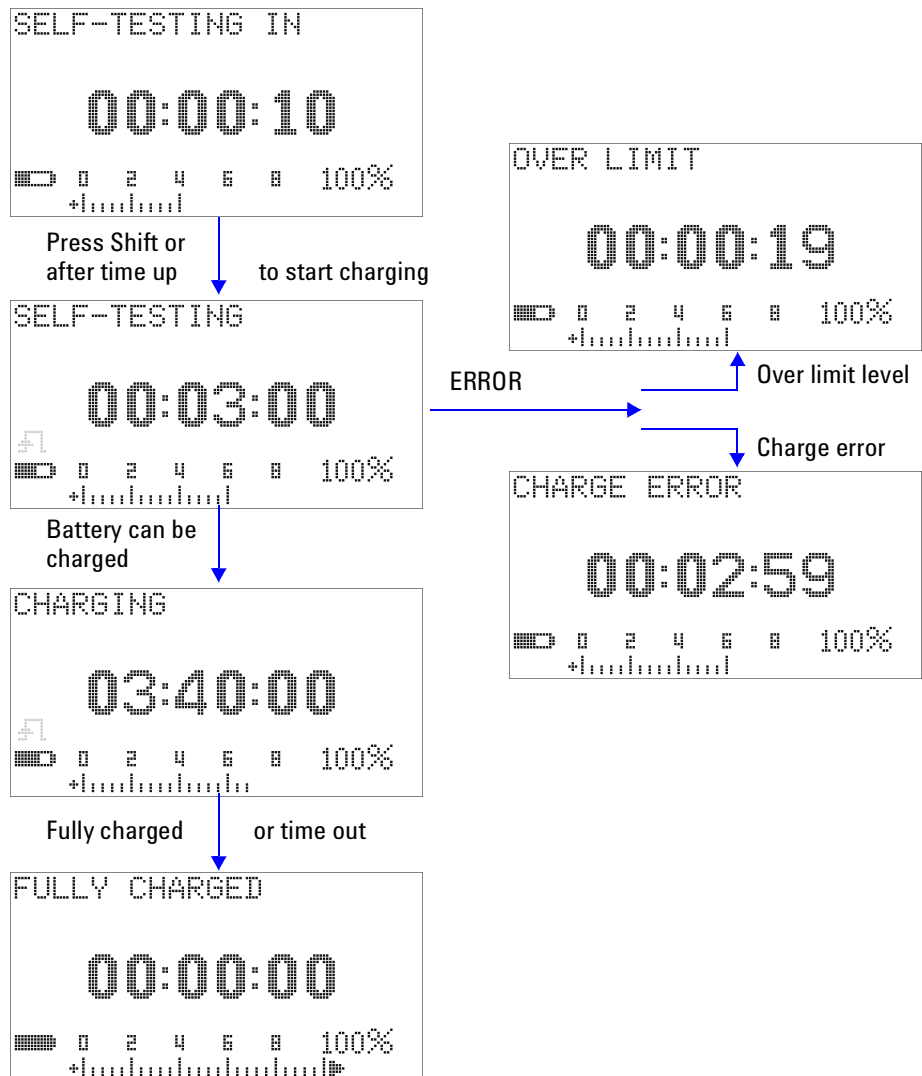

Figure 5-6 Battery charging procedures

Fuse replacement

NOTE

This manual provides only the fuse replacement procedures, but not the fuse replacement markings.

Replace any blown fuse in the multimeter according to the following procedures:

- 1 Turn the multimeter off and disconnect the test leads. Ensure that the charging adapter is also removed, if it is attached to the multimeter.
- 2 Wear clean and dry gloves on your hands and avoid touching any components except the fuse(s) and plastic parts. It is not necessary to recalibrate the multimeter after replacing a fuse.
- 3 Remove the battery cover compartment.
- 4 Loosen two side screws and one lower screw on the bottom case and remove the bottom case.
- 5 Loosen the two screws on the top corners to take out the circuit board.
- 6 Gently remove the defective fuse by prying one end of the fuse loose and removing it from the fuse bracket.
- 7 Replace with a new fuse of the same size and rating. Make sure the new fuse is centered in the fuse bracket.
- 8 Ensure that the knob of the rotary switch on the top case and the corresponding switch on the circuit board remain at the OFF position.
- 9 Refasten the circuit board and the bottom cover.
- 10 Refer to [Table 5-3](#) on page 132 for the part number, rating, and size of the fuses.

Table 5-3 Fuse specifications

Fuse	Agilent part number	Rating	Size	Type
1	2110-1400	440 mA/1000 V	10 mm × 35 mm	Fast blow fuse
2	2110-1402	11 A/1000 V	10 mm × 38 mm	

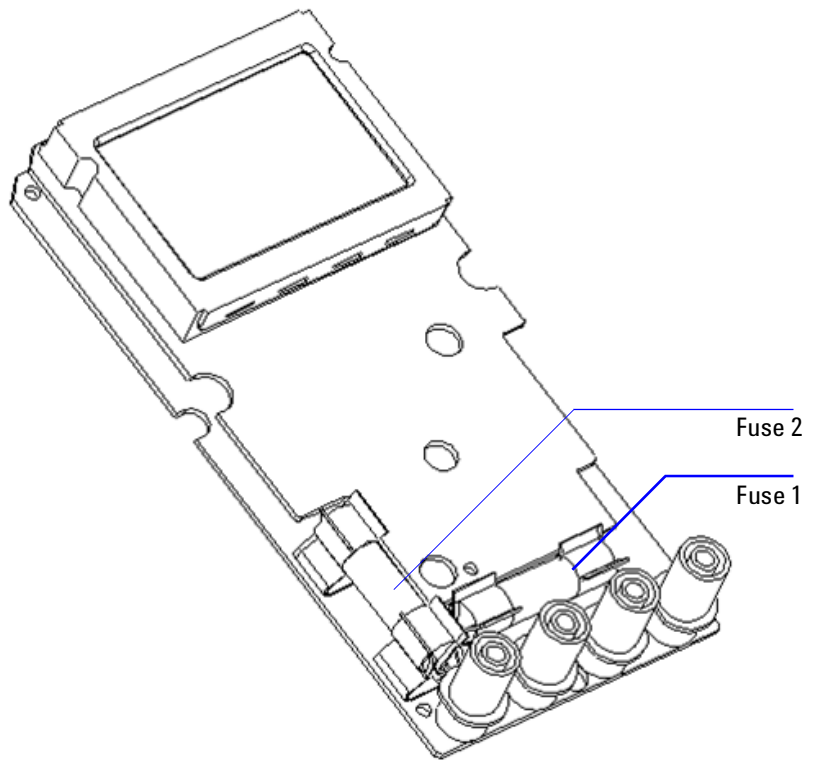

Figure 5-7 Fuse replacement

Troubleshooting

WARNING

To avoid electric shock, do not perform any servicing unless you are qualified to do so.

If the instrument fails to operate, check the battery and test leads. Replace them if necessary. After that, if the instrument still does not function, check to ensure that you have followed the operating procedures given in this instruction manual, before considering servicing the instrument.

When servicing the instrument, use only the specified replacement parts.

Table 5-4 will assist you in identifying some basic problems.

Table 5-4 Basic troubleshooting procedures

Malfunction	Troubleshooting procedure
No OLED display after switching ON	<ul style="list-style-type: none"> Check battery. Charge or replace battery.
No beeper tone	<ul style="list-style-type: none"> Check the Setup mode to verify whether the beeper function has been set to OFF. If so, select the desired driving frequency.
Failed to measure current	<ul style="list-style-type: none"> Check the fuse.
No charging indication	<ul style="list-style-type: none"> Check external DC adapter to ensure that its output is DC 24 V and that the plugs are inserted properly into the charging terminals.
Remote control failure	<ul style="list-style-type: none"> The Agilent logo on the IR-USB cable connected to the multimeter should be facing up. Check the baud rate, parity, data bit, and stop bit (default is 9600, None, 8, and 1) in the Setup mode. Ensure that the required driver for IR-USB has been installed.

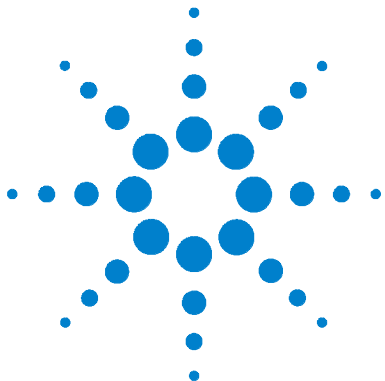

6 Performance Tests and Calibration

Calibration Overview	136
Recommended Test Equipment	138
Basic Operating Tests	139
Test Considerations	142
Performance Verification Tests	144
Calibration Security	151
Adjustment Considerations	158
Calibration from Front Panel	163

This chapter contains the performance test and adjustment procedures. The performance test procedure verifies that the U1253B true RMS OLED multimeter is operating within its published specifications. The adjustment procedure ensures that the multimeter remains within its specifications until the next calibration.



Calibration Overview

This manual contains procedures for verifying the instrument performance, as well as procedures for making adjustments where necessary.

NOTE

Make sure you have read “[Test Considerations](#)” on page 142 before calibrating the instrument.

Closed-case electronic calibration

The U1253B true RMS OLED multimeter features closed-case electronic calibration. In other words, no internal electro-mechanical adjustment is required. This instrument calculates correction factors based on the input reference signals you feed into it during the calibration process. The new correction factors are stored in nonvolatile EEPROM memory until the next calibration (adjustment) is performed. The contents of this nonvolatile EEPROM memory will not change even when the power is switched off.

Agilent Technologies’ calibration services

When your instrument is due for calibration, contact your local Agilent Service Center for a low-cost recalibration.

Calibration interval

A one-year interval is adequate for most applications. Accuracy specifications are warranted only if calibration is performed at regular intervals. Accuracy specifications are not warranted beyond the one-year calibration interval. Agilent does not recommend extending calibration intervals beyond 2 years for any application.

Other recommendations for calibration

Specifications are only guaranteed within the specified period from the last calibration. Agilent recommends that readjustment should be performed during the calibration process for best performance. This will ensure that the U1253B true RMS OLED multimeter remains within its specifications. This calibration criterion provides the best long-term stability.

During performance verification tests, only the performance data is collected; these tests do not guarantee that the instrument will remain within the specified limits. The tests are only for identifying which functions need adjustment.

Please refer to “[Calibration count](#)” on page 171 and verify that all adjustments have been performed.

Recommended Test Equipment

The test equipment recommended for the performance verification and adjustment procedures is listed below. If the exact instrument is not available, substitute with another calibration standard of equivalent accuracy.

Table 6-1 Recommended test equipment

Application	Recommended equipment	Recommended accuracy requirements
DC voltage	Fluke 5520A	< 20% of U1253B accuracy spec
DC current	Fluke 5520A	< 20% of U1253B accuracy spec
Resistance	Fluke 5520A	< 20% of U1253B accuracy spec
AC voltage	Fluke 5520A	< 20% of U1253B accuracy spec
AC current	Fluke 5520A	< 20% of U1253B accuracy spec
Frequency	Agilent 33250A	< 20% of U1253B accuracy spec
Capacitance	Fluke 5520A	< 20% of U1253B accuracy spec
Duty cycle	Fluke 5520A	< 20% of U1253B accuracy spec
Nanosiemens	Fluke 5520A	< 20% of U1253B accuracy spec
Diode	Fluke 5520A	< 20% of U1253B accuracy spec
Frequency counter	Agilent 33250A	< 20% of U1253B accuracy spec
Temperature	Fluke 5520A	< 20% of U1253B accuracy spec
Square wave	Agilent 53131A and Agilent 34401A	< 20% of U1253B accuracy spec
Short	Shorting plug - dual banana plug with copper wire shorting the 2 terminals	< 20% of U1253B accuracy spec
Battery level	Fluke 5520A	< 20% of U1253B accuracy spec

Basic Operating Tests

These basic operating tests are for testing the basic operation of the instrument. Repair is required if the instrument fails any of these basic operating tests.

Testing the display

Press and hold the  button while turning on the multimeter to view all the OLED pixels. Check for dead pixels.

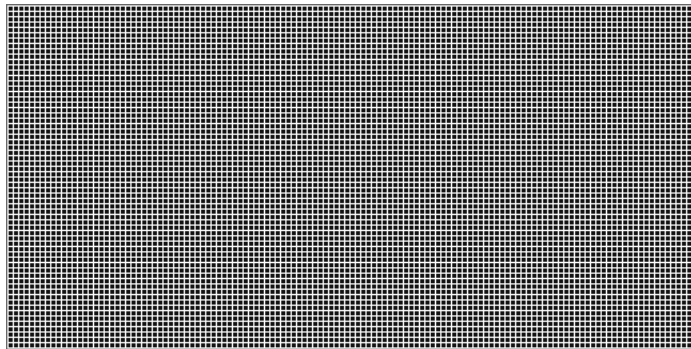



Figure 6-1 Displaying all OLED pixels

Current terminals test

This test determines whether the input warning for the current terminals is functioning properly.

Turn the rotary switch to any non-off position other than **mA·A** . Insert the test leads to the **A** and **COM** terminals. An error message **Error ON A INPUT** (as shown in Figure 6-2) will be displayed on the secondary display, and a continuous beep will persist until the positive lead is removed from the **A** terminal.

NOTE

Before conducting this test, make sure the beep function is not disabled in Setup.

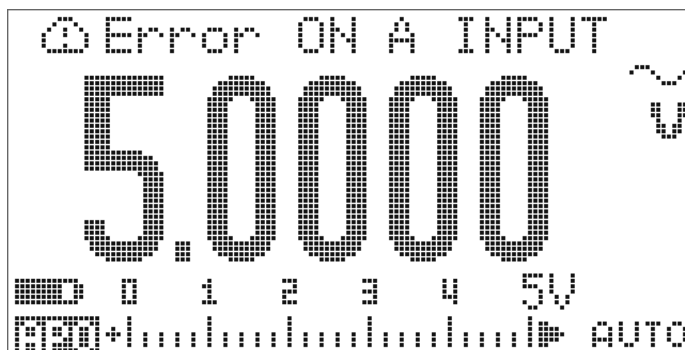

Figure 6-2 Current terminal error message

Charge terminals alert test

This test determines whether the charge terminal alert is functioning properly.

Set the rotary switch to any position other than **OFF** **CHG**, **mA·A**, **μA** or **OUT ms**.

Provide a voltage level more than 5 V to the **CHG** terminal. An error message **Error ON mA INPUT** (as shown in [Figure 6-3](#)) will be displayed on the secondary display, and a continuous beep will persist until the positive lead is removed from the **CHG** terminal.

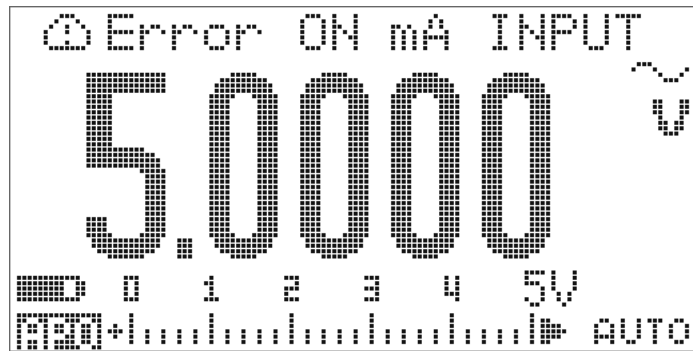

Figure 6-3 Charge terminal error message

NOTE

Before conducting this test, make sure the beep function is not disabled in Setup.

Test Considerations

Long test leads can act as antennas that pick up AC signal noises.

For optimum performance, all procedures should comply with the following recommendations:

- Ensure that the ambient temperature is stable and between 18 °C and 28 °C. Ideally, calibration should be performed at 23 °C ± 1 °C.
- Ensure that ambient relative humidity is less than 80%.
- Allow a 5-minute warm-up period during which a shorting plug is used to connect the **V** and **COM** input terminals.
- Use shielded twisted-pair Teflon-insulated cables to reduce settling and noise errors. Keep the input cables as short as possible.
- Connect the input cable shields to earth. Except where otherwise indicated in the procedures, connect the calibrator LO source to earth at the calibrator. It is important that the LO-to-earth connection be made at only one place in the circuit to avoid ground loops.

Please ensure that the calibration standards and test procedures used do not introduce additional errors.

For DC voltage, DC current, and resistance gain verification measurements, you should ensure that the calibrator's "0" output is correct. You will need to set the offset for each range of the measurement function being verified.

Input Connections

For low-thermal offset measurements, test connections to the instrument are best accomplished by shorting the two terminals using dual banana plug with copper wire short. Shielded twisted-pair Teflon interconnect cables of minimum length are recommended between the calibrator and the multimeter. Cable shields should be grounded to earth. This configuration is recommended for optimal noise and settling time performance during calibration.

Performance Verification Tests

Use the following performance verification tests to verify the measurement performance of the U1253B true RMS OLED multimeter. These performance verification tests are based on the specifications listed in the instrument data sheet.





These performance verification tests are recommended as acceptance tests when you first receive the instrument. After acceptance, you should repeat the performance verification tests at every calibration interval (to be performed before calibration to identify which measurement functions and ranges require calibration).

If any or all of the parameters fail the performance verification, then adjustment or repair is required.

Carry out the performance verification tests according to [Table 6-2](#) on page 145. For every listed step:

- 1** Connect the calibration standard terminals to the appropriate terminals on the U1253B true RMS OLED multimeter.
- 2** Set up the calibration standard with the signals specified in the “Reference signals/values” column (one setting at a time, if more than one setting is listed).
- 3** Turn the rotary switch of the U1253B true RMS OLED multimeter to the function being tested, and choose the correct range, as specified in the table.
- 4** Check whether the measured reading falls within the specified error limits from the reference value. If yes, then this particular function and range does not require adjustment (calibration). If no, then adjustment is necessary.

Table 6-2 Performance verification tests

Step	Test function	Range	Reference signals/values	Error limits
			5520A output	
1	Turn the rotary switch to the  V position ^[1]	5 V	5 V, 1 kHz 5 V, 10 kHz 5 V, 20 kHz 5 V, 30 kHz 5 V, 100 kHz	± 22.5 mV ± 32.5 mV ± 79.0 mV ± 187.0 mV ± 187.0 mV
		50 V	50 V, 1 kHz 50 V, 10 kHz 50 V, 20 kHz 50 V, 30 kHz 50 V, 100 kHz	± 225.0 mV ± 225.0 mV ± 790.0 mV ± 1.87 V ± 1.87 V
		500 V	500 V, 1 kHz 500 V, 10 kHz	± 2.25 V ± 2.25 V
		1000 V	1000 V, 1 kHz	± 8.0 V
2	Press  to switch to frequency mode	9.9999 kHz	0.48 V, 1 kHz	± 500 mHz
3	Press  to switch to duty cycle mode	0.01% to 99.99%	5.0 Vpp @ 50%, square wave, 50 Hz	± 0.315%
4	Turn the rotary switch to the  V position Press  to select DC V measurement	5 V	5 V	± 1.75 mV
		50 V	50 V	± 17.5 mV
		500 V	500 V	± 200 mV
		1000 V	1000 V	± 800 mV

6 Performance Tests and Calibration

Table 6-2 Performance verification tests







Step	Test function	Range	Reference signals/values	Error limits
5	Press  to select AC V measurement ^[1]	5 V	5 V, 1 kHz 5 V, 10 kHz 5 V, 20 kHz 5 V, 100 kHz	± 22.5 mV ± 32.5 mV ± 79 mV ± 187 mV
		50 V	50 V, 1 kHz 50 V, 10 kHz 50 V, 20 kHz 50 V, 100 kHz	± 225 mV ± 225 mV ± 790 mV ± 1.87 V
		500 V	500 V, 1 kHz 500 V, 10 kHz	± 2.25 V ± 2.25 V
		1000 V	1000 V, 1 kHz	± 8.0 V
6	Turn the rotary switch to the  mV position Press  to select DC mV measurement	50 mV	50 mV	± 75 μ V ^[2]
		500 mV	500 mV -500 mV	± 175 μ V ± 175 μ V
		1000 mV	1000 mV -1000 mV	± 0.75 mV ± 0.75 mV

Table 6-2 Performance verification tests

Step	Test function	Range	Reference signals/values	Error limits
7	Press  to select AC mV measurement ^[1]	50 mV	50 mV, 1 kHz 50 mV, 10 kHz 50 mV, 20 kHz 50 mV, 30 kHz 50 mV, 100 kHz	± 0.24 mV ± 0.39 mV ± 0.415 mV ± 1.87 mV ± 1.87 mV
		500 mV	500 mV, 45 Hz 500 mV, 1 kHz 500 mV, 10 kHz 500 mV, 20 kHz 500 mV, 30 kHz 500 mV, 100 kHz	± 8.1 mV ± 2.25 mV ± 2.25 mV ± 4.15 mV ± 18.7 mV ± 18.7 mV
		1000 mV	1000 mV, 1 kHz 1000 mV, 10 kHz 1000 mV, 20 kHz 1000 mV, 30 kHz 1000 mV, 100 kHz	± 6.5 mV ± 6.5 mV ± 11.5 mV ± 47 mV ± 47 mV
8	Turn the rotary switch to the  position	500 Ω	500 Ω	± 350 mΩ ^[3]
		5 kΩ	5 kΩ	± 3 Ω
		50 kΩ	50 kΩ	± 30 Ω
		500 kΩ	500 kΩ	± 300 Ω
		5 MΩ	5 MΩ	± 8 kΩ
		50 MΩ ^[4]	50 MΩ	± 505 kΩ
		500 MΩ	500 MΩ	± 40.1 MΩ
9	Press  to select conductance (nS) measurement	500 nS ^[5]	50 nS	± 0.6 nS
10	Turn the rotary switch to the  position	Diode	1 V	± 1 mV

6 Performance Tests and Calibration

Table 6-2 Performance verification tests













Step	Test function	Range	Reference signals/values	Error limits
			33250A output	
11	Press  to select frequency counter ^[6]	999.99 kHz	200 mVrms, 100 kHz	± 52 Hz
12	Press  to select divide-by-100 frequency counter mode	99.999 MHz	600 mVrms, 10 MHz	± 5.2 kHz
			5520A output	
13	Turn the rotary switch to the  position ^[7]	10.000 nF	10.000 nF	± 108 pF
		100.00 nF	100.00 nF	± 1.05 nF
		1000.0 nF	1000.0 nF	± 10.5 nF
		10.000 μF	10.000 μF	± 105 nF
		100.00 μF	100.00 μF	± 1.05 μF
		1000.0 μF	1000.0 μF	± 10.5 μF
		10.000 mF	10.000 mF	± 105 μF
		100.00 mF	100.00 mF	± 3.1 mF
14	Press  to select temperature measurement ^[8]	-40 °C to 1372 °C	0 °C 100 °C	± 1 °C ± 2 °C
15	Turn the rotary switch to the  position	500 μA	500 μA	± 0.3 μA ^[9]
		5000 μA	5000 μA	± 3 μA ^[9]
16	Press  to select ACμA measurement ^[1]	500 μA	500 μA, 1 kHz 500 μA, 20 kHz	± 3.7 μA ± 3.95 μA
		5000 μA	5000 μA, 1 kHz 5000 μA, 20 kHz	± 37 μA ± 39.5 μA
17	Turn the rotary switch to the  position	50 mA	50 mA	± 80 μA ^[9]
		440 mA	400 mA	± 0.65 mA ^[9]

Table 6-2 Performance verification tests

Step	Test function	Range	Reference signals/values	Error limits
18	Press  to select AC mA measurement ^[1]	50 mA	50 mA, 1 kHz 50 mA, 20 kHz	± 0.37 mA ± 0.395 mA
		440 mA	400 mA, 45 Hz 400 mA, 1 kHz	± 4.2 mA ± 3 mA
Caution: Connect calibrator outputs to handheld multimeters A and COM terminal before applying 5 A and 10 A				
19	Press  to select DC A measurement	5 A	5 A	± 16 mA
		10 A ^[10]	10 A	± 35 mA
20	Press  to select AC A measurement	5 A	5 A, 1 kHz	± 37 mA
		3 A	3 A, 5 kHz	± 96 mA
		10 A ^[11]	10 A, 1 kHz	± 90 mA
		Square wave output	Measure with 53131A	
21	Turn the rotary switch to the  OUT ms position	120 Hz @ 50%		± 26 mHz
		4800 Hz @ 50%		± 260 mHz
	 OUT ms duty cycle	100 Hz @ 50%		$\pm 0.398\%$ ^[12]
100 Hz @ 25%			$\pm 0.398\%$ ^[12]	
100 Hz @ 75%			$\pm 0.398\%$ ^[12]	
			Measure with 34410A	
	 OUT ms amplitude	4800 Hz @ 99.609%		± 0.2 V

^[1] The additional error to be added for frequency > 20 kHz and signal input < 10% of range: 300 counts of LSD per kHz.

^[2] An accuracy of 0.05% + 10 can be achieved by using the relative function to zero the thermal effect (short test leads) before measuring the signal.

6 Performance Tests and Calibration

- [3] The accuracy of 500 Ω and 5 k Ω is specified after the Null function.
- [4] For the range of 50 M Ω /500 M Ω , the relative humidity is specified for < 60%.
- [5] The accuracy is specified for < 50 nS, with the Null function performed on open test leads.
- [6] All frequency counters are susceptible to error when measuring low-voltage, low-frequency signals. Shielding inputs from external noise pickup is critical for minimizing measurement errors.
- [7] Use the Null function to offset for residuals.
- [8] The accuracy does not include the tolerance of thermocouple probes. The thermal sensor plugged into the multimeter should be placed in the operating environment for at least an hour.
- [9] Always use the relative function to zero the thermal effect with open test leads before measuring the signal. If you do not use the relative function, add 20 digits to the error.
- [10] 10 A continuous, and additional 0.5% error to specified accuracy when measuring a signal greater than 10 A to 20 A for 30 seconds maximum. After measuring a current of > 10 A, cool down the multimeter for twice the measuring time you applied before performing a low current measurement.
- [11] The current can be measured from 2.5 A to 10 A continuous, with an additional 0.5% error to specified accuracy when measuring a signal greater than 10 A to 20 A for 30 seconds maximum. After measuring a current of > 10 A, cool down the multimeter for twice the measuring time you applied before performing a low current measurement.
- [12] For signal frequencies greater than 1 kHz, an additional 0.1% error per kHz needs to be added to the accuracy.

Calibration Security

A calibration security code is in place to prevent accidental or unauthorized adjustments to the U1253B true RMS OLED multimeter. When you first receive your instrument, it is secured. Before you can adjust the instrument, you must “unsecure” it by entering the correct security code (see [“Unsecuring the instrument for calibration”](#) on page 151).

The security code is set as 1234 when the instrument is shipped from the factory. The security code is stored in nonvolatile memory, which does not change even when the power is off.

NOTE

You can unsecure the instrument and then change the security code from the front panel or through the remote interface.

NOTE



See [“Resetting the security code to factory default”](#) on page 156 if you forget your security code.







Unsecuring the instrument for calibration

Before you can adjust the instrument, you must unsecure it by entering the correct security code, either from the front panel, or through PC remote interface.



The default security code is 1234.

From front panel

- 1 Turn the rotary switch to the $\sim V$ position (you may also start with another rotary switch position; but here we assume that you will follow the exact steps listed in [Table 6-2](#)).
- 2 Press  and  simultaneously to enter the Calibration Security Code entry mode.

- 3 The secondary display will indicate “CSC:I 5555”, where the character “I” signifies “input”.
- 4 Press  or  to start entering the code (by editing the existing number “5555” one digit at a time).
- 5 Press  or  to choose which digit to edit, and press  or  to edit the value.
- 6 Press  (Save) when done.
- 7 If the correct security code is entered, the upper left corner of the secondary display will show the word “PASS” for 3 seconds.
- 8 If the incorrect security code is entered, an error code will be displayed instead for 3 seconds, after which the Calibration Security Code entry mode will appear again.

Please refer to [Figure 6-4](#) on page 153.

To secure the instrument again (exit the unsecured mode), press  and  simultaneously.

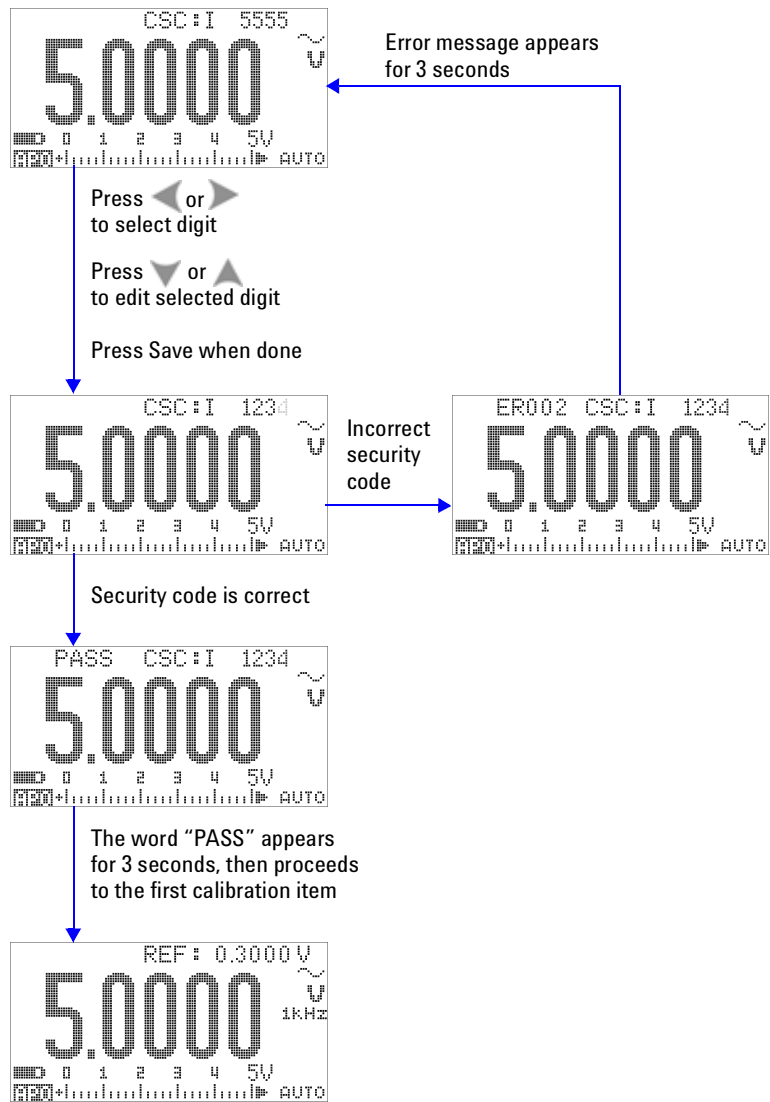









Figure 6-4 Unsecuring the instrument for calibration

Changing Calibration Security Code

From front panel

- 1 After unsecuring the instrument, press  for more than 1 second to enter Calibration Security Code setting mode.
- 2 The existing code will be shown on the secondary display, for example, “CSC:C 1234”, where the character “C” signifies “change”.
- 3 Press  or  to start and choose which digit to edit, and press  or  to edit the value. (To exit without changing the code, press  for more than 1 second.)
- 4 Press  (Save) to save the new security code.
- 5 If the new calibration security code has been successfully stored, the upper left corner of the secondary display will momentarily show the word “PASS”.

Please refer to [Figure 6-5](#) on page 155.

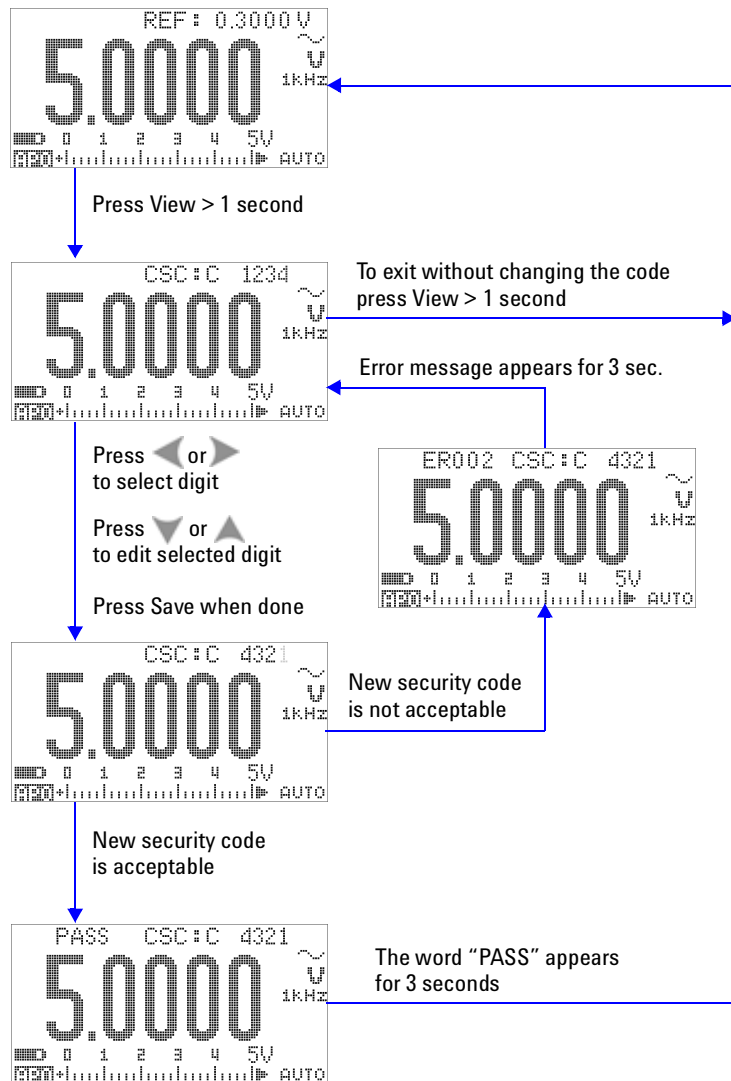









Figure 6-5 Changing the calibration security code

Resetting the security code to factory default

If you have forgotten the correct security code, you may follow the steps below to change the security code back to the factory default (1234).

NOTE

If you do not have a record (or have lost the record) of the security code, first try the factory default code, 1234, through the front panel or remote interface. There is always the possibility that the security code has never been changed at all.

- 1 Record the last 4 digits of the instrument serial number.
- 2 Turn the rotary switch to the \sim V position.
- 3 Press  and  simultaneously to enter the Calibration Security Code entry mode.
- 4 The secondary display will indicate “CSC:I 5555” as a cue for you to enter the security code. However, since you do not have the security code, proceed to the next step.
- 5 Without entering the security code, press  for more than 1 second to enter Set Default Security Code mode. The secondary display will indicate “SCD:I 5555”.
- 6 Press  or  to start and choose which digit to edit, and press  or  to edit the value. Set these to be the same as the last 4 digits of the instrument serial number.
- 7 Press  (Save) to confirm the entry.
- 8 If the number entered is the correct last 4 digits of the serial number, the upper left corner of the secondary display will momentarily show “PASS”.

Now the security code has been reset to the factory default, 1234. If you wish to change the security code, refer to [“Changing Calibration Security Code”](#) on page 154. Make sure you record the new security code.

Please refer to [Figure 6-6](#) on page 157.

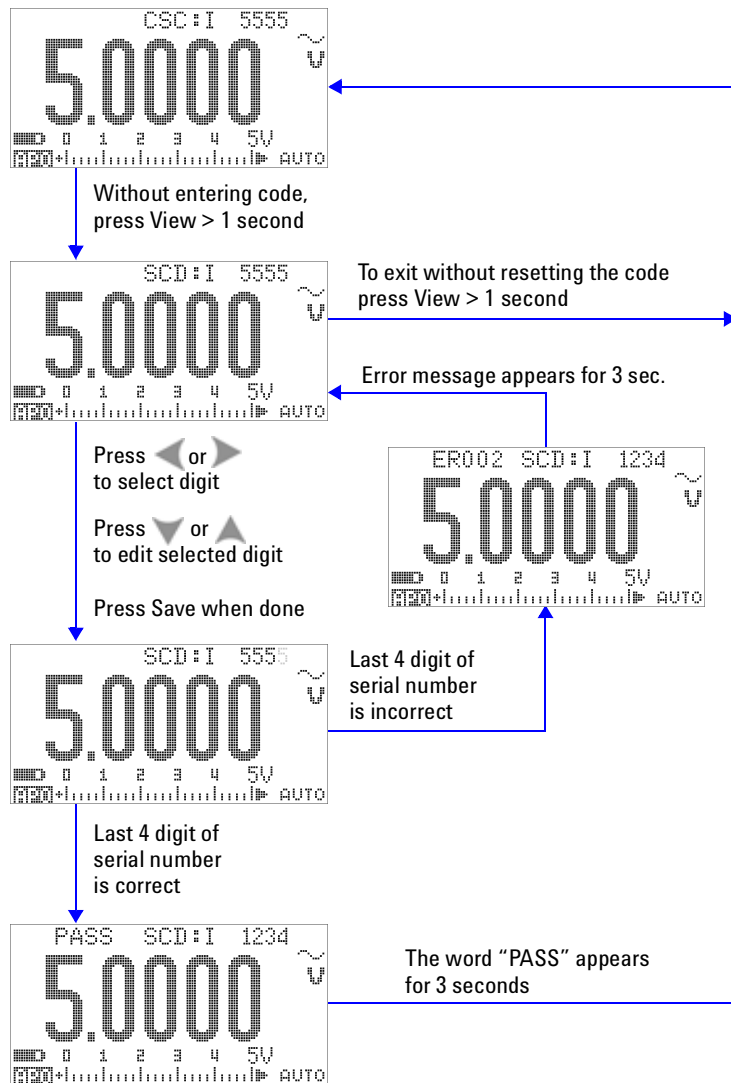

Figure 6-6 Resetting security code to factory default

Adjustment Considerations

To adjust the instrument, you will need a test input cables and connectors set for receiving the reference signals (for example, from the Fluke 5520A calibrator or Agilent 33250A function/arbitrary waveform generator) and a shorting plug. Please refer to [“Input Connections”](#) on page 143.

NOTE

After each successful adjustment, the secondary display briefly shows “PASS”. If the calibration fails, the instrument emits a beep, and an error code is shown momentarily on the secondary display. For a list of calibration error codes, refer to [“Calibration error codes”](#) on page 172. In the event of a calibration failure, correct the problem and repeat the procedure.

Adjustments for each function should be performed with the following considerations (where applicable):

- 1 Allow the instrument to warm up and stabilize for 5 minutes before performing the adjustments.
- 2 Ensure that during the adjustment, the low-battery indicator does not appear. Replace/recharge the battery as soon as possible to avoid false reading.
- 3 Consider thermal effects as you connect test leads to the calibrator and this instrument. It is recommended that you wait for 1 minute after connecting the test leads before you begin the calibration.
- 4 During ambient temperature adjustment, ensure that the instrument has been turned on for at least 1 hour with the K-type thermocouple connected between the instrument and the calibration source.

CAUTION

Never turn off the instrument during calibration. This may delete the calibration memory for the present function.

Valid adjustment reference input values

Adjustments can be performed using the following reference input values:

Table 6-3 Valid adjustment reference input values

Function	Range	Reference input value	Valid range for reference input
DC mV	Short	SHORT	Short V and COM terminals
	50 mV	30.000 mV	0.9 to 1.1 × reference input value
	500 mV	300.00 mV	0.9 to 1.1 × reference input value
	1000 mV	1000.0 mV	0.9 to 1.1 × reference input value
AC mV	50 mV	3.000 mV (1 kHz)	0.9 to 1.1 × reference input value
		30.000 mV (1 kHz)	0.9 to 1.1 × reference input value
		30.000 mV (10 kHz)	0.9 to 1.1 × reference input value
	500 mV	30.00 mV (1 kHz)	0.9 to 1.1 × reference input value
		300.00 mV (1 kHz)	0.9 to 1.1 × reference input value
		300.00 mV (10 kHz)	0.9 to 1.1 × reference input value
	1000 mV	300.0 mV (1 kHz)	0.9 to 1.1 × reference input value
		1000.0 mV (1 kHz)	0.9 to 1.1 × reference input value
		1000.0 mV (10 kHz)	0.9 to 1.1 × reference input value
DC V	Short	SHORT	Short V and COM terminals
	5 V	3.0000 V	0.9 to 1.1 × reference input value
	50 V	30.000 V	0.9 to 1.1 × reference input value
	500 V	300.00 V	0.9 to 1.1 × reference input value
	1000 V	1000.0 V	0.9 to 1.1 × reference input value

6 Performance Tests and Calibration

Table 6-3 Valid adjustment reference input values



Function	Range	Reference input value	Valid range for reference input
AC V (with rotary switch at  V and  V [2])	5 V	0.3000 V (1 kHz)	0.9 to 1.1 × reference input value
		3.0000 V (1 kHz)	0.9 to 1.1 × reference input value
		3.0000 V (10 kHz)	0.9 to 1.1 × reference input value
	50 V	3.000 V (1 kHz)	0.9 to 1.1 × reference input value
		30.000 V (1 kHz)	0.9 to 1.1 × reference input value
		30.000 V (10 kHz)	0.9 to 1.1 × reference input value
	500 V	30.00 V (1 kHz)	0.9 to 1.1 × reference input value
		300.00 V (1 kHz)	0.9 to 1.1 × reference input value
		300.00 V (10 kHz)	0.9 to 1.1 × reference input value
	1000 V	30.0 V (1 kHz)	0.9 to 1.1 × reference input value
		300.0 V (1 kHz)	0.9 to 1.1 × reference input value
		300.0 V (10 kHz)	0.9 to 1.1 × reference input value
DC μA	Open	OPEN	Open terminals
	500 μA	300.00 μA	0.9 to 1.1 × reference input value
	5000 μA	3000.0 μA	0.9 to 1.1 × reference input value
AC μA	500 μA	30.00 μA ^[1]	0.9 to 1.1 × reference input value
		300.00 μA	0.9 to 1.1 × reference input value
	5000 μA	300.0 μA	0.9 to 1.1 × reference input value
		3000.0 μA	0.9 to 1.1 × reference input value
DC mA/DC A	Open	OPEN	Open terminals
	50 mA	30.000 mA	0.9 to 1.1 × reference input value
	500 mA	300.00 mA	0.9 to 1.1 × reference input value
	5 A	3.000 A	0.9 to 1.1 × reference input value
	10 A	10.000 A	0.9 to 1.1 × reference input value

Table 6-3 Valid adjustment reference input values

Function	Range	Reference input value	Valid range for reference input
AC mA/AC A	50 mA	3.000 mA (1 kHz)	0.9 to 1.1 × reference input value
		30.000 mA (1 kHz)	0.9 to 1.1 × reference input value
	500 mA	30.00 mA (1 kHz)	0.9 to 1.1 × reference input value
		30.000 mA (1 kHz)	0.9 to 1.1 × reference input value
	5 A	0.3000 A (1 kHz)	0.9 to 1.1 × reference input value
		3.0000 A (1 kHz)	0.9 to 1.1 × reference input value
	10 A	0.3000 A (1 kHz)	0.9 to 1.1 × reference input value
		10.000 A (1 kHz)	0.9 to 1.1 × reference input value
Capacitance	Open	OPEN	Open terminals
	10 nF	3.000 nF	0.9 to 1.1 × reference input value
		10.000 nF	0.9 to 1.1 × reference input value
	100 nF	10.00 nF	0.9 to 1.1 × reference input value
		100.00 nF	0.9 to 1.1 × reference input value
	1000 nF	100.0 nF	0.9 to 1.1 × reference input value
		1000.0 nF	0.9 to 1.1 × reference input value
	10 μF	10.000 μF	0.9 to 1.1 × reference input value
	100 μF	100.00 μF	0.9 to 1.1 × reference input value
	1000 μF	1000.0 μF	0.9 to 1.1 × reference input value
10 mF	10.000 mF	0.9 to 1.1 × reference input value	

6 Performance Tests and Calibration

Table 6-3 Valid adjustment reference input values

Function	Range	Reference input value	Valid range for reference input
Resistance ^[3]	Short	SHORT	Short Ω and COM terminals
	50 M Ω	OPEN	Open terminals
		10.000 M Ω	0.9 to 1.1 \times reference input value
	5 M Ω	3.000 M Ω	0.9 to 1.1 \times reference input value
	500 k Ω	300.00 k Ω	0.9 to 1.1 \times reference input value
	50 k Ω	30.000 k Ω	0.9 to 1.1 \times reference input value
	5 k Ω	3.0000 k Ω	0.9 to 1.1 \times reference input value
	500 Ω	300.00 Ω	0.9 to 1.1 \times reference input value
Diode	Diode	SHORT	Short Ω and COM terminals
	2 V	2.0000 V	0.9 to 1.1 \times reference input value
Temperature	K-type	0000.0 $^{\circ}\text{C}$	Provide 0 $^{\circ}\text{C}$ with ambient compensation

^[1] The minimum AC current output Fluke 5520A calibrator is 29.00 μA only. Be sure to set at least 30.00 μA for the calibration source of AC μA .

^[2] Both AC V positions must be calibrated individually.

^[3] Be sure to recalibrate the “Short” using the dual banana plug with copper wire after performing calibration for resistance.

Calibration from Front Panel

Calibration process

The following general procedure is the recommended method to complete a full instrument calibration.

- 1 Read and implement “[Test Considerations](#)” on page 142.
- 2 Perform the verification tests (refer to [Table 6-2](#) on page 145) to characterize the instrument.
- 3 Perform the calibration procedures (refer to “[Calibration procedures](#)” on page 164; read also “[Adjustment Considerations](#)” on page 158).
- 4 Secure the instrument after calibration.
- 5 Take note of the new security code (if it has been changed) and the calibration count in the instrument maintenance records.

NOTE

Make sure to quit the adjustment mode before switching off the instrument.

Calibration procedures





- 1 Turn the rotary switch to the function you wish to calibrate.
- 2 Unsecure the U1253B true RMS OLED multimeter (refer to [“Unsecuring the instrument for calibration”](#) on page 151).
- 3 After verifying that the security code you entered is correct, the instrument will display the reference input value of the next calibration item (refer to [Table 6-4](#) on page 167 for the list and sequence of all the calibration items) on the secondary display after briefly showing “PASS”.
 - For example, if the reference input of the next calibration item is shorting the input terminals, the secondary display will indicate “REF:+SH.ORT”.

NOTE

If you do not intend to perform the complete set of calibration items, you may press ▲ or ▼ to select the item you wish to calibrate.

- 4 Set up the indicated reference input and apply this input to the correct terminals of the U1253B handheld multimeter. For example:
 - If the required reference input is “SHORT”, use a shorting plug to short the two relevant terminals.
 - If the required reference input is “OPEN”, just leave the terminals open.
 - If the required reference input is a voltage, current, resistance, capacitance, or temperature value, set up the Fluke 5520A calibrator (or another device with equivalent standard of accuracy) to provide the necessary input.
- 5 With the required reference input applied to the correct terminals, press  to start the present calibration item.
- 6 During calibration, the primary display and bar-graph will indicate the uncalibrated reading, and the calibration

indicator, “CAL”, will appear on the upper left corner of the secondary display. If the reading is within the acceptable range, the word “PASS” will be shown momentarily, and then the instrument will proceed to the next calibration item. If the reading is out of the acceptable range, it will remain at the present calibration item after showing the error code for 3 seconds. In this case, you need to check whether the correct reference input has been applied. Refer to [Table 6-5](#) on page 172 for the meaning of the error codes.

- 7** Repeat step 4 and step 5 until all calibration items for that particular function have been completed.
- 8** Select another function to be calibrated. Repeat step 4 to step 7.
 - For a rotary switch position that hosts more than one function, for example,  , press  to go to the next function.
- 9** After calibrating all the functions, press  and  simultaneously to exit calibration mode.
- 10** Switch off the instrument and then switch it on again. The instrument will be back to normal measurement mode.

Refer to [Figure 6-7](#) on page 166.

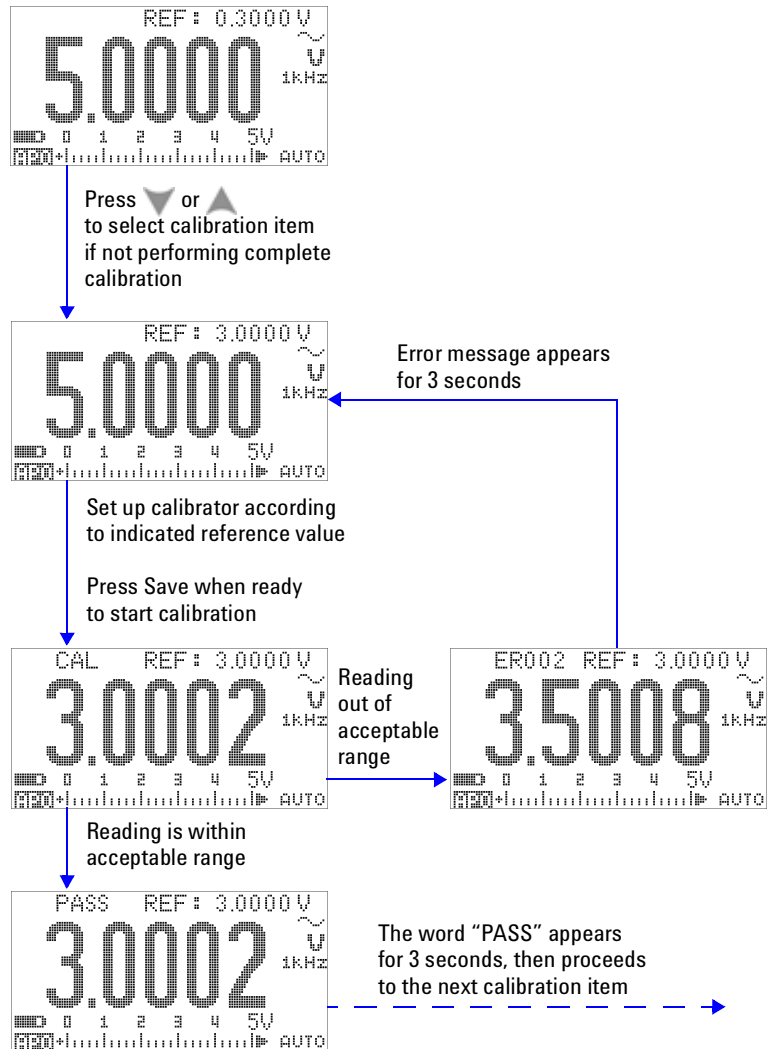





Figure 6-7 Typical calibration process flow

Table 6-4 List of calibration items

Function	Range	Calibration item ^[1]	Reference input
AC V (with rotary switch at  V and  V ^[2])	5 V	0.3000 V (1 kHz) 3.0000 V (1 kHz) 3.0000 V (10 kHz)	0.3 V, 1 kHz 3 V, 1 kHz 3 V, 10 kHz
	50 V	3.000 V (1 kHz) 30.000 V (1 kHz) 30.000 V (10 kHz)	3 V, 1 kHz 30 V, 1 kHz 30 V, 10 kHz
	500 V	30.00 V (1 kHz) 300.00 V (1 kHz) 300.00 V (10 kHz)	30 V, 1 kHz 300 V, 1 kHz 300 V, 10 kHz
	1000 V	30.0 V (1 kHz) 300.0 V (1 kHz) 300.0 V (10 kHz) (done for this function; change rotary switch position or press  to select the next function that requires calibration)	30 V, 1 kHz 300 V, 1 kHz 300 V, 10 kHz
DC V	Short	SHORT	Dual banana shorting plug with copper wire
	5 V	3.0000 V	3 V
	50 V	30.000 V	30 V
	500 V	300.00 V	300 V
	1000 V	1000.0 V (done)	1000 V
DC mV	Short	SHORT	Dual banana shorting plug with copper wire
	50 mV	30.000 mV	30 mV
	500 mV	300.00 mV	300 mV
	1000 mV	1000.0 mV (done)	1000 mV

6 Performance Tests and Calibration

Table 6-4 List of calibration items

Function	Range	Calibration item ^[1]	Reference input
AC mV	50 mV	3.000 mV (1 kHz)	3 mV, 1 kHz
		30.000 mV (1 kHz)	30 mV, 1 kHz
		30.000 mV (10 kHz)	30 mV, 10 kHz
500 mV	500 mV	30.00 mV (1 kHz)	30 mV, 1 kHz
		300.00 mV (1 kHz)	300 mV, 1 kHz
		300.00 mV (10 kHz)	300 mV, 10 kHz
1000 mV	1000 mV	300.0 mV (1 kHz)	300 mV, 1 kHz
		1000.0 mV (1 kHz)	1000 mV, 1 kHz
		1000.0 mV (10 kHz) (done)	1000 mV, 10 kHz
Resistance ^[4]	Short	SHORT	Dual banana shorting plug with copper wire
	50 MΩ	OPEN	Unplug all test leads or shorting plug, and leave the terminals open
		10.000 MΩ	10 MΩ
	5 MΩ	3.0000 MΩ	3 MΩ
	500 kΩ	300.00 kΩ	300 kΩ
	50 kΩ	30.000 kΩ	30 kΩ
	5 kΩ	3.0000 kΩ	3 kΩ
500 Ω	300.00 Ω (done)	300 Ω	
Diode	Short	SHORT	Dual banana shorting plug with copper wire
	2 V	2.0000 V (done)	2 V



Table 6-4 List of calibration items

Function	Range	Calibration item ^[1]	Reference input
Capacitance	Open	OPEN	Unplug all test leads or shorting plug, and leave the terminals open
	10 nF	3.000 nF 10.000 nF	3 nF 10 nF
	100 nF	10.00 nF 100.00 nF	10 nF 100 nF
	1000 nF	100.0 nF 1000.0 nF	100 nF 1000 nF
	10 μ F	10.000 μ F	10 μ F
	100 μ F	100.00 μ F	100 μ F
	1000 μ F	1000.0 μ F	1000 μ F
	10 mF	10.000 mF (done)	10 mF
Temperature	K-type	0000.0 $^{\circ}$ C (done)	0 $^{\circ}$ C
DC μ A	Open	OPEN	Unplug all test leads or shorting plug, and leave the terminals open
	500 μ A	300.00 μ A	300 μ A
	5000 μ A	3000.0 μ A (done)	3000 μ A
AC μ A	500 μ A	30.00 μ A (1 kHz) ^[3] 300.00 μ A (1 kHz)	30 μ A, 1 kHz 300 μ A, 1 kHz
	5000 μ A	300.0 μ A (1 kHz) 3000.0 μ A (1 kHz) (done)	300 μ A, 1 kHz 3000 μ A, 1 kHz

6 Performance Tests and Calibration

Table 6-4 List of calibration items

Function	Range	Calibration item ^[1]	Reference input
DC mA/DC A	Open for all ranges	OPEN	Unplug all test leads or shorting plug, and leave the terminals open
	50 mA	30.000 mA	30 mA
	500 mA	300.00 mA	300 mA
	Move the positive test lead from the μA.mA terminal to the A terminal.		
	Caution: Connect the calibrator to the multimeters A and COM terminals before applying 3 A and 10 A.		
	5 A	3.0000 A	3 A
	10 A	10.000 A (done)	10 A
AC mA/AC A	50 mA	3.000 mA (1 kHz) 30.000 mA (1 kHz)	3 mA, 1 kHz 30 mA, 1 kHz
	500 mA	30.00 mA (1 kHz) 300.00 mA (1 kHz)	30 mA, 1 kHz 300 mA, 1 kHz
	Move the positive test lead from the μA.mA terminal to the A terminal.		
	Caution: Connect the calibrator to the multimeters A and COM terminals before applying 3 A and 10 A.		
	5 A	0.3000 A (1 kHz) 3.0000 A (1 kHz)	0.3 A, 1 kHz 3 A, 1 kHz
	10 A	3.000 A (1 kHz) 10.000 A (1 kHz) (done)	3 A, 1 kHz 10 A, 1 kHz

[1] Press  or  to select the calibration item (if not performing the complete set of calibration). After successfully calibrating an item, the multimeter will automatically proceed to the next item.

[2] Both AC V positions must be calibrated individually.

[3] The minimum AC current output of the Fluke 5520A calibrator is 29.0 μ A, therefore, an output of at least 30.0 μ A must be set for the calibrator.



[4] Be sure to recalibrate the “Short” using the dual banana plug with copper wire after performing calibration for resistance.

Calibration count

The calibration count feature provides an independent “serialization” of your calibrations. With it, you can determine the number of times your instrument has been calibrated. By monitoring the calibration count, you can tell whether an unauthorized calibration has been performed. The value increments by one each time the instrument is calibrated.

The calibration count is stored in a nonvolatile EEPROM memory, the contents of which do not change even after the instrument is switched off or after a remote interface reset. Your U1253B true RMS OLED multimeter had been calibrated before leaving the factory. When you receive your multimeter, make sure to read the calibration count and record it for maintenance purpose.

The calibration count increases up to a maximum of 65535, after which it wraps around to 0. There is no way to program or reset the calibration count. It is an independent electronic “serialization” value.

To view the present calibration count, unsecure the instrument from the front panel (see [“Unsecuring the instrument for calibration”](#) on page 151), and then press  to view the calibration count. Press  again to exit the calibration count display.

Calibration error codes

Table 6-5 below lists the various error codes for the calibration process.

Table 6-5 Calibration error codes and their respective meanings

Error code	Description
ER200	Calibration error: Calibration mode is secured.
ER002	Calibration error: Security code invalid.
ER003	Calibration error: Serial number invalid.
ER004	Calibration error: Calibration aborted.
ER005	Calibration error: Value out of range.
ER006	Calibration error: Signal measurement out of range.
ER007	Calibration error: Frequency out of range.
ER008	EEPROM write failure.

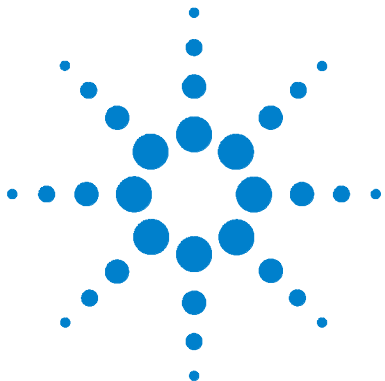

7 Specifications

DC Specifications	174
AC Specifications	177
AC+DC Specifications	179
Temperature and Capacitance Specifications	181
Temperature specifications	181
Capacitance specifications	182
Frequency Specifications	183
Frequency sensitivity during voltage measurement	183
Frequency sensitivity during current measurement	184
Frequency counter specifications	186
Peak hold (capturing changes)	187
Square wave output	187
Operating Specifications	188
General Specifications	191
Measurement Category	193
Measurement category definition	193

This chapter details the specifications of the U1253B true RMS OLED multimeter.



DC Specifications

These specifications are defined for measurements taken after at least one minute warm-up.

Table 7-1 DC accuracy \pm (% of reading + number of LSD)

Function	Range ^[10]	Resolution	Test current or burden voltage	Accuracy
Voltage ^[1]	50.000 mV	0.001 mV		0.05+50 ^[2]
	500.00 mV	0.01 mV		0.025+5
	1000.0 mV	0.1 mV		0.025+5
	5.0000 V	0.0001 V		0.025+5
	50.000 V	0.001 V		0.025+5
	500.00 V	0.01 V		0.030+5
	1000.0 V	0.1 V		0.030+5
Resistance ^{[11][15]}	500.00 Ω ^[3]	0.01 Ω	1.04 mA	0.05+10
	5.0000 k Ω ^[3]	0.0001 k Ω	416 μ A	0.05+5
	50.000 k Ω	0.001 k Ω	41.2 μ A	0.05+5
	500.00 k Ω	0.01 k Ω	4.12 μ A	0.05+5
	5.0000 M Ω	0.0001 M Ω	375 nA 10 M Ω	0.15+5
	50.000 M Ω ^[4]	0.001 M Ω	187 nA 10 M Ω	1.00+5
	500.00 M Ω ^[4]	0.01 M Ω	187 nA 10 M Ω	3.00+5, < 200 M 8.00+5, > 200 M
	500.00 nS ^[5]	0.01 nS	187 nA	1+10

Table 7-1 DC accuracy \pm (% of reading + number of LSD)

Function	Range ^[10]	Resolution	Test current or burden voltage	Accuracy
DC current	500.00 μ A	0.01 μ A	< 0.06 V (100 Ω)	0.05+5 ^[6]
	5000.0 μ A	0.1 μ A	0.6 V (100 Ω)	0.05+5 ^[6]
	50.000 mA	0.001 mA	0.09 V (1 Ω)	0.15+5 ^[6]
	440.00 mA	0.01 mA	0.9 V (1 Ω)	0.15+5 ^[6]
	5.0000 A	0.0001 A	0.2 V (0.01 Ω)	0.30+10
	10.000 A ^[7]	0.001 A	0.4 V (0.01 Ω)	0.30+5
Continuity ^[8]	500.00 Ω	0.01 Ω	1.04 mA	0.05+10
Diode test ^[9] [12][15]	3.0000 V	0.1 mV	1.04 mA	0.05+5

^[1] Input impedance: Refer to [Table 7-18](#).

^[2] The accuracy could be 0.05%+5; always use the Null function to zero out thermal effect (short test leads) before measuring the signal.

^[3] The accuracy of 500 Ω and 5 k Ω is specified after applying the Null function, which is used to subtract the test lead resistance and the thermal effect.

^[4] For the range of 50 M Ω /500 M Ω , the relative humidity is specified for < 60%.

^[5] The accuracy is specified for < 50 nS, after applying the Null function with open test lead.

^[6] Always use the Null function to zero out thermal effect with open test leads before measuring the signal. If Null function is not used, an additional 20 counts need to be added to the accuracy. Thermal effect could occur due to the following:

- Wrong operation — where the resistance, diode, or mV measurement function is used to measure high voltage signals within the range of 50 V to 1000 V.
- After battery-charging has completed.
- After measuring a current greater than 500 mA, it is recommended that the meter be left to cool down for twice the measurement time used.

^[7] Current can be measured up to 10 A continuously. An additional 0.5% needs to be added to the specified accuracy if the signal measured is in the range of 10 A to 20 A for 30 seconds maximum. After measuring a current of > 10 A, leave the meter to cool down (in switched OFF state) for twice the measurement time used, before using it again to make low-current measurement.

7 Specifications

[8] Instant continuity: built-in beeper will sound when resistance is less than 10.0 Ω .

[9] Built-in beeper will sound when the reading is below approximately 50 mV. Also, single-tone beeping for normal forward-biased diode or semiconductor junction with bias voltage between 0.3 V and 0.8 V.

[10] 2% over-range on all ranges except DC 1000 V.

[11] These specifications are defined for 2-wire ohms using Math Null. Without Math Null, add 0.2 Ω additional error.

[12] These specifications are defined for voltages measured at the input terminals only. The test current is typical. Variation in the current source will create some variation in voltage drop across a diode junction.

[13] These specifications are defined for the conditions that the test leads are open, and Math Null function is used.

[14] For total measurement accuracy, add temperature probe error.

[15] Maximum open voltage: <+4.2 V

AC Specifications

These specifications are defined for measurements of sine wave, taken after at least 1 minute warm-up.

Table 7-2 Accuracy specifications \pm (% of reading + number of LSD) for true RMS AC voltage

Range	Resolution	Accuracy for true RMS AC voltage ^{[2] [8][10]}				
		20 Hz to 45 Hz	45 Hz to 1 kHz	1 kHz to 10 kHz	10 kHz to 20 kHz	20 kHz to 100 kHz ^[1]
50.000 mV	0.001 mV	1.5+20	0.4+40	0.7+40	0.75+40	3.5+120
500.00 mV	0.01 mV	1.5+60	0.4+25	0.4+25	0.75+40	3.5+120
1000.0 mV	0.1 mV	1.5+60	0.4+25	0.4+25	0.75+40	3.5+120
5.0000 V	0.0001 V	1.5+60	0.4+25	0.6+25	1.5+40	3.5+120
50.000 V	0.001 V	1.5+60	0.4+25	0.4+25	1.5+40	3.5+120
500.00 V	0.01 V	1.5+60	0.4+25	0.4+25	1.5+40	3.5+120 ^[3]
1000.0 V	0.1 V	1.5+60	0.4+40	0.4+40	1.5+40 ^[3]	No spec.

Table 7-3 Accuracy specifications \pm (% of reading + number of LSD) for true RMS AC current

Range	Resolution	Accuracy for true RMS AC current ^{[8] [5]}			
		20 Hz to 45 Hz	45 Hz to 1 kHz	1 kHz to 20 kHz	20 kHz to 100 kHz ^[1]
500.00 μ A ^[4]	0.01 μ A	1.0+20	0.7+20	0.75+20	5+80
5000.0 μ A	0.1 μ A	1.0+20	0.7+20	0.75+20	5+80
50.000 mA	0.001 mA	1.0+20	0.7+20	0.75+20	5+80
440.00 mA	0.01 mA	1.0+20	0.7+20	1.5+20	5+80
5.0000 A	0.0001 A	1.5+20 ^[6]	0.7+20	3+60	No spec.
10.000 A	0.001 A	1.5+20 ^[6]	0.7+20	< 3 A / 5 kHz	No spec.

^[1] Additional error to be added for frequency > 20 kHz and signal input < 10% of range: 3 counts of LSD per kHz.

7 Specifications

- [2] Input impedance: Refer to [Table 7-18](#).
- [3] The input signal is lower than the product of 20000000V×Hz (product of voltage and frequency).
- [4] Input current > 35 μ Arms.
- [5] Current can be measured from 2.5 A up to 10 A continuously. An additional 0.5% needs to be added to the specified accuracy if the signal measured is in the range of 10 A to 20 A for 30 seconds maximum. After measuring a current of > 10 A, leave the meter to cool down (in switched OFF state) for twice the measurement time used, before using it again to make low-current measurement.
- [6] Input current < 3 Arms.
- [7] 2% over-range on all ranges except AC 1000 V.
- [8] These specifications are defined for signal input > 5% of range.
- [9] For 5 A and 10 A ranges, the frequency is verified for less than 5 kHz.
- [10] Crest factor \leq 3.0 at full scale, 5.0 at half scale except the 1000 mV and 1000 V ranges where it is 1.5 at full scale, 3.0 at half scale. For non-sinusoidal waveform, add 0.1% of reading \pm 0.3% of range.

AC+DC Specifications

These specifications are defined for measurements of sine wave, taken after at least 1 minute warm-up.

Table 7-4 Accuracy specifications \pm (% of reading + number of LSD) for AC+DC voltage

Range	Resolution	Accuracy for AC+DC voltage ^[2] ^[8]				
		30 Hz to 45 Hz	45 Hz to 1 kHz	1 kHz to 10 kHz	10 kHz to 20 kHz	20 kHz to 100 kHz ^[1]
50.000 mV	0.001 mV	1.5+80	0.4+60	0.7+60	0.8+60	3.5+220
500.00 mV	0.01 mV	1.5+65	0.4+30	0.4+30	0.8+45	3.5+125
1000.0 mV	0.1 mV	1.5+65	0.4+30	0.4+30	0.8+45	3.5+125
5.0000 V	0.0001 V	1.5+65	0.4+30	0.6+30	1.5+45	3.5+125
50.000 V	0.001 V	1.5+65	0.4+30	0.4+30	1.5+45	3.5+125
500.00 V	0.01 V	1.5+65	0.4+30	0.4+30	1.5+45	3.5+125 ^[3]
1000.0 V	0.1 V	1.5+65	0.4+45	0.4+45	1.5+45 ^[3]	No spec.

Table 7-5 Accuracy specifications \pm (% of reading + number of LSD) for AC+DC current

Range	Resolution	Accuracy for AC+DC current ^[5] ^[8]			Overload protection
		30 Hz to 45 Hz	45 Hz to 1 kHz	1 kHz to 20 kHz	
500.00 μ A ^[4]	0.01 μ A	1.1+25	0.8+25	0.8+25	440 mA
5000.0 μ A	0.1 μ A	1.1+25	0.8+25	0.8+25	10 \times 35 mm
50.000 mA	0.001 mA	1.2+25	0.9+25	0.9+25	AC/DC 1000 V
440.00 mA	0.01 mA	1.2+25	0.9+25	0.9+25	30 kA/fast-acting
5.0000 A	0.0001 A	1.8+30 ^[6]	0.9+30	3.3+70, < 3A / 5 kHz	11 A
10.000 A	0.001 A	1.8+30 ^[6]	0.9+25	3.3+70, < 3A / 5 kHz	

^[1] Additional error to be added for frequency > 20 kHz and signal input < 10% of range: 3 counts of LSD per kHz.

7 Specifications

- [2] Input impedance: Refer to [Table 7-18](#).
- [3] The input voltage is lower than 200 Vrms.
- [4] Input current > 35 μ Arms.
- [5] Current can be measured from 2.5 A up to 10 A continuously. An additional 0.5% needs to be added to the specified accuracy if the signal measured is in the range of 10 A to 20 A for 30 seconds maximum.. After measuring a current of > 10 A, leave the meter to cool down (in switched OFF state) for twice the measurement time used, before using it again to make low-current measurement.
- [6] Input current < 3 Arms.
- [7] 2% over-range on all ranges except AC 1000 V.
- [8] These specifications are defined for signal input > 5% of range.
- [9] For 5 A and 10 A ranges, the frequency is verified for less than 5 kHz.

Temperature and Capacitance Specifications

Temperature specifications

Table 7-6 Temperature specifications

Thermal type	Range	Resolution	Accuracy ^[1]
K	–200°C to –40°C	0.1°C	1% + 3°C
	–328°F to –40°F	0.1°F	1% + 5.4°F
	–40°C to 1372°C	0.1°C	1% + 1°C
	–40°F to 2502°F	0.1°F	1% + 1.8°F
J	–210°C to –40°C	0.1°C	1% + 3°C
	–346°F to –40°F	0.1°F	1% + 5.4°F
	–40°C to 1372°C	0.1°C	1% + 1°C
	–40°F to 2502°F	0.1°F	1% + 1.8°F

^[1] The accuracy is specified according to the following conditions:

- The accuracy does not include the tolerance of the thermocouple probe. The thermal sensor plugged into the meter should be placed in the operating environment for at least an hour prior to measurement.
- Use the Null function to reduce the thermal effect. Before using Null function, set the meter to no ambient compensation mode ( is indicated) and keep the thermocouple as close to the meter as possible. Avoid contact with any surface that has a different temperature from the ambient temperature.
- When measuring temperature with respect to any temperature calibrator, try to set both the calibrator and meter with external reference (without internal ambient compensation). If both calibrator and meter are set with internal reference (with internal ambient compensation), there may be a deviation between the readings of the calibrator and the meter, due to differences in ambient compensation between the two devices.

Capacitance specifications

Table 7-7 Capacitance specifications

Range	Resolution	Accuracy	Measurement rate at full scale	Maximum display
10.000 nF	0.001 nF	1%+8	4 times/second	11000 counts
100.00 nF	0.01 nF	1%+5		
1000.0 nF	0.1 nF			
10.000 μ F	0.001 μ F			
100.00 μ F	0.01 μ F			
1000.0 μ F	0.1 μ F			
10.000 mF	0.001 mF	3%+10		
100.00 mF	0.01 mF		0.1 time/second	
			0.01 time/second	

[1] Overload protection: 1000 Vrms for circuits with < 0.3 A short circuit.

[2] With film capacitor or better, use Null function to zero out residual.

Frequency Specifications

Table 7-8 Frequency specifications

Range	Resolution	Accuracy	Minimum Input Frequency ^[1]
99.999 Hz	0.001 Hz	0.02% + 3 ^[2]	1 Hz
999.99 Hz	0.01 Hz	0.02%+3 < 600 kHz	
9.9999 kHz	0.0001 kHz		
99.999 kHz	0.001 kHz		
999.99 kHz	0.01 kHz		

^[1] The input signal is lower than the product of 20000000V×Hz (product of voltage and frequency); overload protection: 1000 V.

^[2] For non-square wave signals, an additional 5 counts need to be added.

Frequency sensitivity during voltage measurement

Table 7-9 Frequency sensitivity and trigger level

Input range ^[1]	Minimum sensitivity (rms sine wave)		Trigger level for DC coupling	
	20 Hz to 200 kHz	> 200 kHz to 500 kHz	< 100 kHz	> 100 kHz to 500 kHz
50 mV	10 mV	25 mV	10 mV	25 mV
500 mV	70 mV	150 mV	70 mV	150 mV
1000 mV	120 mV	300 mV	120 mV	300 mV
5 V	0.3 V	1.2 V	0.6 V	1.5 V
50 V	3 V	5 V	6 V	15 V

Table 7-9 Frequency sensitivity and trigger level

Input range ^[1]	Minimum sensitivity (rms sine wave)		Trigger level for DC coupling	
	20 Hz to 200 kHz	> 200 kHz to 500 kHz	< 100 kHz	> 100 kHz to 500 kHz
500 V	30 V, < 100 kHz	No spec.	60 V	No spec.
1000 V	50 V, < 100 kHz	No spec.	120 V	No spec.

^[1] Maximum input for specified accuracy = 10 × range or 1000 V.

Frequency sensitivity during current measurement

Table 7-10 Sensitivity for current measurement

Input range	Minimum sensitivity (rms sine wave)
	20 Hz to 20 kHz
500 μA	100 μA
5000 μA	250 μA
50 mA	10 mA
440 mA	25 mA
5 A	1 A
10 A	2.5 A

^[1] For maximum input, please refer to AC current measurement.

^[2] The accuracy for duty cycle and pulse width is based on a 5 V square wave input to the DC 5 V range. For AC coupling, the duty cycle range can be measured within the range of 5% to 95% for signal frequency > 20 Hz.

Duty cycle ^[1] and pulse width ^[2]

Table 7-11 Accuracy for duty cycle

Mode	Range	Accuracy of full scale
DC coupling	0.01% to 99.99%	0.3% per kHz + 0.3%

Table 7-12 Accuracy for pulse width

Range	Resolution	Accuracy
500 ms	0.01 ms	0.2%+3
2000 ms	0.1 ms	0.2%+3

^[1] The accuracy for duty cycle and pulse width is based on a 5 V square wave input into the DC 5 V range. For AC coupling, the duty cycle range can be measured within 5% to 95% for signal frequency > 20 Hz.

^[2] Positive or negative pulse width must be greater than 10 μ s and the range of duty cycle should be considered. The range of pulse width is determined by the frequency of the signal.

Frequency counter specifications

Table 7-13 Frequency counter (divide 1) specifications

Range	Resolution	Accuracy	Sensitivity	Minimum input freq.
99.999 Hz	0.001 Hz	0.02%+3 ^[2]	100 mVrms	0.5 Hz
999.99 Hz	0.01 Hz	0.002%+5 < 985 kHz		
9.9999 kHz	0.0001 kHz			
99.999 kHz	0.001 kHz			
999.99 kHz	0.01 kHz		200 mVrms	

Table 7-14 Frequency counter (divide 100) specifications

Range	Resolution	Accuracy	Sensitivity	Minimum input freq.
9.9999 MHz	0.0001 MHz	0.002%+5	400 mVrms	1 MHz
99.999 MHz	0.001 MHz	< 20 MHz	600 mVrms	

^[1] The maximum measurement level is < 30 Vpp.

^[2] All frequency counters are susceptible to error when measuring low-voltage, low-frequency signals. Shielding inputs from picking up external noise is critical for minimizing measurement errors. For non-square wave signals, an additional 5 counts need to be added.

^[3] The minimum measurement frequency of low frequency is set by power-on option to speed up the measurement rate.

Peak hold (capturing changes)

Table 7-15 Peak hold specification

Signal width	Accuracy for DC mV/V/current
Single event > 1 ms	2%+400 for all ranges
Repetitive > 250 μ s	2%+1000 for all ranges

Square wave output

Table 7-16 Square wave output specifications

Output ^[1]	Range	Resolution	Accuracy
Frequency	0.5, 1, 2, 5, 6, 10, 15, 20, 25, 30, 40, 50, 60, 75, 80, 100, 120, 150, 200, 240, 300, 400, 480, 600, 800, 1200, 1600, 2400, 4800 Hz	0.01 Hz	0.005%+2
Duty cycle ^{[2][4]}	0.39% to 99.60%	0.390625%	0.4% of full scale ^[3]
Pulse width ^{[2][4]}	1/Frequency	Range/256	0.2 ms + (range/256)
Amplitude	Fixed: 0 to +2.8 V	0.1 V	0.2 V

^[1] Output impedance: 3.5 k Ω maximum.

^[2] The positive or negative pulse width must be greater than 50 μ s for adjusting the duty cycle or pulse width under different frequencies. Otherwise, the accuracy and range will differ from the definition.

^[3] For signal frequency greater than 1 kHz, an additional 0.1% per kHz is added to the accuracy.

^[4] The accuracy for duty cycle and pulse width is based on a 5 V square wave input without dividing signal.

Operating Specifications

Measurement rate (approximate)

Table 7-17 Measurement rate

Function	Times/second
AC V	7
AC V + dB	7
DC V (V or mV)	7
AC V (V or mV)	7
AC+DC V (V or mV)	2
Ω / nS	14
Diode	14
Capacitance	4 (< 100 μ F)
DC A (μ A, mA, or A)	7
AC A (μ A, mA, or A)	7
AC+DC A (μ A, mA, or A)	2
Temperature	6
Frequency	1 (> 10 Hz)
Duty cycle	0.5 (> 10 Hz)
Pulse width	0.5 (> 10 Hz)

Input Impedance

Table 7-18 Input Impedance

Function	Range	Input Impedance
DC Voltage ^[1]	50.000 mV	10.00 MΩ
	500.00 mV	10.00 MΩ
	1000.0 mV	10.00 MΩ
	5.0000 V	11.10 MΩ
	50.000 V	10.10 MΩ
	500.00 V	10.01 MΩ
	1000.0 V	10.001 MΩ
AC Voltage ^[2]	50.000 mV	10.00 MΩ
	500.00 mV	10.00 MΩ
	1000.0 mV	10.00 MΩ
	5.0000 V	10.00 MΩ
	50.000 V	10.00 MΩ
	500.00 V	10.00 MΩ
	1000.0 V	10.00 MΩ
AC + DC Voltage ^[2]	50.000 mV	10.00 MΩ
	500.00 mV	10.00 MΩ
	1000.0 mV	10.00 MΩ
	5.0000 V	11.10 MΩ 10 MΩ
	50.000 V	10.10 MΩ 10 MΩ
	500.00 V	10.01 MΩ 10MΩ
	1000.0 V	10.001 MΩ 10MΩ

7 Specifications

- [1] For 5 V to 1000 V range, the specified input impedance in parallel with 10 M Ω at dual display.
- [2] The specified input impedance (nominal) in parallel with < 100 pF.

General Specifications

Display

- Graphical Orange OLED (organic light-emitting diode) display with maximum reading of 51000 counts.
- Automatic polarity indication.

Power consumption

420 mVA maximum.

Operating environment

- Temperature: Full accuracy from $-20\text{ }^{\circ}\text{C}$ to $55\text{ }^{\circ}\text{C}$.
- Humidity: Full accuracy up to 80% R.H. (relative humidity) for temperature up to $35\text{ }^{\circ}\text{C}$, decreasing linearly to 50% R.H. at $55\text{ }^{\circ}\text{C}$.
- Altitude:
 - 0 to 2000 meters: in compliance with IEC 61010-1 2nd Edition CAT III, 1000 V/ CAT IV, 600 V.
 - 2000 to 3000 meters: in compliance with IEC 61010-1 2nd Edition CAT III, 1000 V/ CAT IV, 600 V.

Storage temperature

From $-40\text{ }^{\circ}\text{C}$ to $70\text{ }^{\circ}\text{C}$, with battery removed.

Measurement category

Category III 1000 V/ Category IV, 600 V Overvoltage Protection, Pollution Degree 2

Common Mode Rejection Ratio (CMRR)

More than 100 dB at DC, 50/60 Hz $\pm 0.1\%$ (1 k Ω unbalanced).

Normal Mode Rejection Ratio (NMRR)

More than 90 dB at 50/60 Hz \pm 0.1%.

Temperature coefficient

0.15 \times (specified accuracy) / $^{\circ}$ C (from -20 $^{\circ}$ C to 18 $^{\circ}$ C, or 28 $^{\circ}$ C to 55 $^{\circ}$ C).

Shock and vibration

Tested to IEC/EN 60068-2.

Dimensions (L \times W \times H)

203.5 \times 94.4 \times 59.0 mm (8.01 \times 3.71 \times 2.32 inches)

Weight

527 \pm 5 grams with battery

Battery type

- 7.2 V or 8.4 V Ni-MH Rechargeable battery
- 9 V Alkaline battery (ANSI/NEDA 1604A or IEC 6LR61)
- 9 V Carbon-zinc battery (ANSI/NEDA 1604D or IEC6F22)

Charging time

Less than **220 minutes**, in an environment of 10 $^{\circ}$ C to 30 $^{\circ}$ C. If the battery has been deep-discharged, a prolonged charging time is required to bring the battery back to full capacity.

Warranty

- 3 years for main unit.
- 3 months for standard accessories unless otherwise specified.

Measurement Category

The Agilent U1253B True RMS OLED Multimeter has a safety rating of CAT III 1000 V/ CAT IV, 600 V.

Measurement category definition

Measurement CAT I is for measurements performed on circuits not directly connected to the AC mains.. Examples are measurements on circuits not derived from the AC mains and specially protected (internal) mains-derived circuits.

Measurement CAT II are measurements performed on circuits directly connected to a low voltage installation. Examples are measurements on household appliances, portable tools, and similar equipment.

Measurement CAT III are measurements performed in the building installation. Examples are measurements on distribution boards, circuit-breakers, wiring, including cables, bus-bars, junction boxes, switches, socket outlets in the fixed installation, and equipment for industrial use, and some other equipment including stationary motors with permanent connection to the fixed installation.

Measurement CAT IV are measurements performed at the source of the low-voltage installation. Examples are electricity meters and measurements on primary over current protection devices and ripple control units.

www.agilent.com

Contact us

To obtain service, warranty or technical assistance, contact us at the following phone or fax numbers:

United States:

(tel) 800 829 4444 (fax) 800 829 4433

Canada:

(tel) 877 894 4414 (fax) 800 746 4866

China:

(tel) 800 810 0189 (fax) 800 820 2816

Europe:

(tel) 31 20 547 2111

Japan:

(tel) (81) 426 56 7832 (fax) (81) 426 56 7840

Korea:

(tel) (080) 769 0800 (fax) (080) 769 0900

Latin America:

(tel) (305) 269 7500

Taiwan:

(tel) 0800 047 866 (fax) 0800 286 331

Other Asia Pacific Countries:

(tel) (65) 6375 8100 (fax) (65) 6755 0042

Or visit Agilent World Wide Web at:

www.agilent.com/find/assist

Product specifications and descriptions in this document are subject to change without notice. Always refer to Agilent Web site for the latest revision.

© Agilent Technologies, Inc. , 2009

First Edition, December 1, 2009

U1253-90035



Agilent Technologies