

T591, Tantalum, Polymer Tantalum, 10 uF, 20%, 35 VDC, SMD, Polymer, Molded, Low ESR, 120 mOhms, 7343, Height Max = 3.1mm

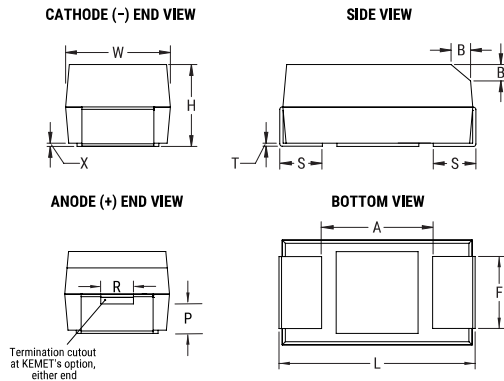

Dimensions	
Footprint	7343
L	7.3mm +/-0.3mm
W	4.3mm +/-0.3mm
H	2.8mm +/-0.3mm
T	0.13mm REF
S	1.3mm +/-0.3mm
F	2.4mm +/-0.1mm
A	3.8mm MIN
B	0.5mm +/-0.15mm
P	0.9mm REF
R	1mm REF
X	0.1mm +/-0.1mm

Packaging Specifications	
Weight:	434.83 mg
Packaging:	T&R, 178mm
Packaging Quantity:	500

General Information	
Supplier:	KEMET
Series:	T591
Dielectric:	Polymer Tantalum
Style:	SMD Chip
Description:	SMD, Polymer, Molded, Low ESR
Features:	Automotive
RoHS:	Yes
Termination:	Tin
Qualifications:	AEC-Q200 (Limited 500 Hrs 85C/85% RH/Ur)
AEC-Q200:	No
Shelf Life:	52 Weeks
MSL:	3

Specifications	
Capacitance:	10 uF
Capacitance Tolerance:	20%
Voltage DC:	35 VDC (105C), 23.45 VDC (125C)
Temperature Range:	-55/+125C
Rated Temperature:	105°C
Humidity:	85C, 85% RH, load, 500 Hours
Dissipation Factor:	10.00% 120Hz 25C
Failure Rate:	N/A
Resistance:	120 mOhms (100kHz 25C)
Ripple Current:	1369 mAmps (100kHz 45C), 1232.1 mAmps (85C), 342.3 mAmps (125C)
Leakage Current:	35 uA (5min 25C)

Statements of suitability for certain applications are based on our knowledge of typical operating conditions for such applications, but are not intended to constitute - and we specifically disclaim - any warranty concerning suitability for a specific customer application or use. This Information is intended for use only by customers who have the requisite experience and capability to determine the correct products for their application. Any technical advice inferred from this Information or otherwise provided by us with reference to the use of our products is given gratis, and we assume no obligation or liability for the advice given or results obtained.