

# Features

## Unregulated Converters

- High Isolation 2W Converter
- Approved for Medical Applications
- Custom Solutions Available
- 3kVDC and 4kVDC Isolation Options
- UL94V-0 Package Material
- Optional Continuous Short Circuit Protected
- Efficiency to 84%
- Suitable for IGBT Applications

**Description** The RKZ Series of 2W DC/DC Converters are certified to EN 60950-1 and to the medical standard EN-60601-1. This makes them suitable for high end industrial applications such as IGBT driver circuitry as well as standard medical applications. The RUZ converters are pin-compatible with the RK and RH converter series, offering a simple way to upgrade a 1W high isolation supply to 2W.

### Selection Guide

Part Number	4kV	Input Voltage (VDC)	Output Voltage (VDC)	Output Current (mA)	Efficiency (%)	Max Capacitive Load <sup>(1)</sup>
RKZ-xx05S*	(H)	5, 12	5	400	82-84	1200µF
RKZ-xx12S*	(H)	5, 12	12	168	82-84	680µF
RKZ-xx15S*	(H)	5, 12	15	132	82-84	680µF
RKZ-xx05D*	(H)	5, 12	±5	±200	70-82	±470µF
RKZ-xx12D*	(H)	5, 12	±12	±84	82-84	±220µF
RKZ-xx15D*	(H)	5, 12	±15	±66	82-84	±220µF
RKZ-xx1509D*	(H)	5, 12, 24	+15/-9	+67/-111	70-81	±330µF

xx = Input Voltage. Other input and output voltage combinations available on request.

\* add Suffix "P" for Continuous Short Circuit Protection, e.g. RKZ-0515D/P, e.g. RKZ-0515D/HP has 4kV Isolation and is Short Circuit Protected.

### Specifications (measured at T<sub>A</sub> = 25°C, nominal input voltage, full load and after warm-up)

Input Voltage Range		±10%	
Output Voltage Accuracy		±5%	
Line Voltage Regulation		1.2%/1% of V <sub>in</sub> typ.	
Load Voltage Regulation (10% to 100% load)	5V type	15% max.	
	Other types, RKZ-xx1509D	10% max.	
Output Ripple and Noise (20MHz limited)		150mVp-p max.	
Operating Frequency		35kHz min. / 50kHz typ. / 85kHz max.	
	RKZ-xx1509D	20kHz min. / 51kHz typ.	
Efficiency at Full Load		70% min. / 80% typ.	
Minimum Load = 0%		Specifications valid for 10% minimum load only.	
Isolation Voltage	(tested for 1 second)	3000VDC	
	(rated for 1 minute**)	1500VAC / 60Hz	
Isolation Voltage	H-Suffix (tested for 1 second)	4000VDC	
	H-Suffix (rated for 1 minute**)	2000VAC / 60Hz	
Isolation Capacitance		30pF min. / 110pF max.	
Isolation Resistance		15 GΩ min.	
Short Circuit Protection		1 sec	
Operating Temperature Range (free air convection, without derating)		-40°C to +90°C (see Graph)	
Storage Temperature Range		-55°C to +125°C	
Relative Humidity		95% RH	
Package Weight		2.8g	
Packing Quantity		25 pcs per Tube	
MTBF (+25°C)	Detailed Information see Application Notes chapter "MTBF"	using MIL-HDBK 217F	988 x 10 <sup>3</sup> hours
(+85°C)		using MIL-HDBK 217F	135 x 10 <sup>3</sup> hours

continued on next page

# ECONOLINE

## DC/DC-Converter

with 3 year Warranty

# RECOM

## 2 Watt

## SIP7

## Single & Dual Output



**EN-60950-1 Certified**  
**IEC/EN-60601-1 Certified\***  
 \* +15/-9 Version excluded

# RKZ

## Derating-Graph (Ambient Temperature)

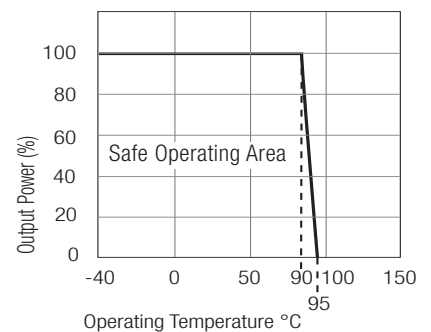

\*\*Any data referred to in this datasheet are of indicative nature and based on our practical experience only. For further details, please refer to our Application Notes.

Refer to Application Notes

## Specifications (measured at $T_A = 25^\circ\text{C}$ , nominal input voltage, full load and after warm-up)

### Certifications

EN General Safety  
EN Medical safety

Report: SPCLVD1109103  
Report: SPCMDD1205098-4

EN60950-1:2006 + A12:2011  
IEC/EN 60601-1:2006, 3rd Edition

### Notes

Note 1 Maximum capacitive load is defined as the capacitive load that will allow start up in under 1 second without damage to the converter.

## Typical Characteristics

### RKZ-xx05S

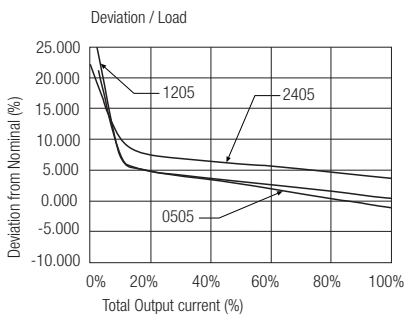
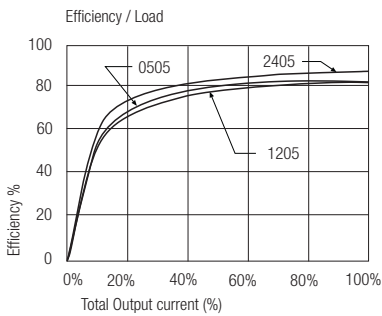

### RKZ-xx12S

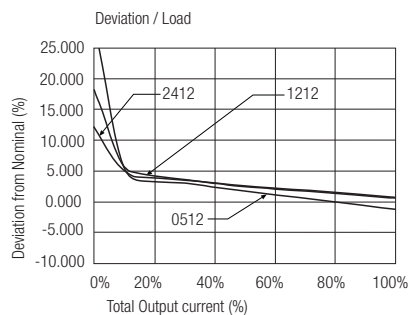
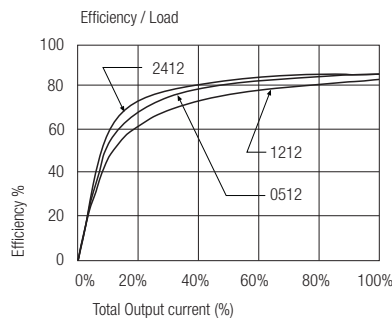

### RKZ-xx15S

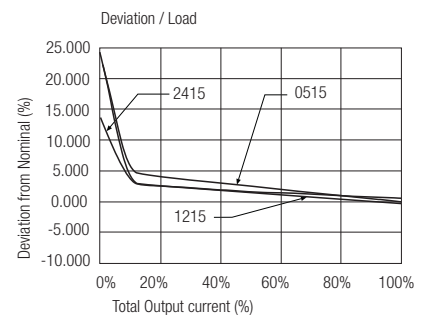
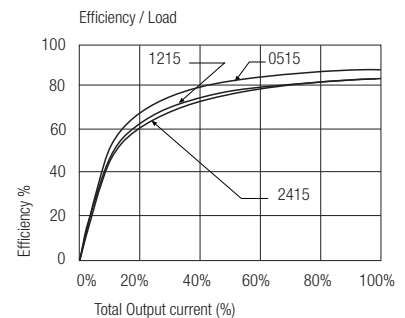

### RKZ-xx05D

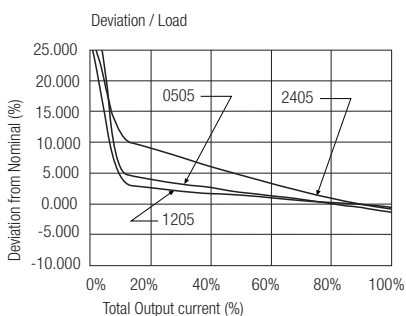
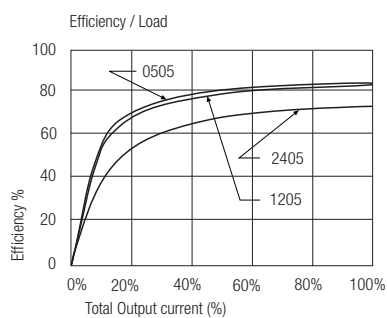

### RKZ-xx12D

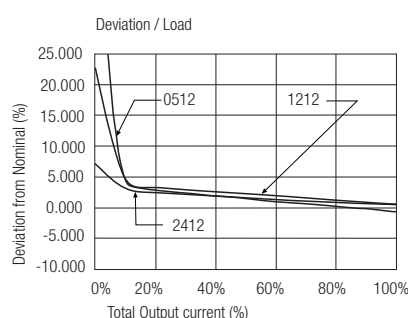
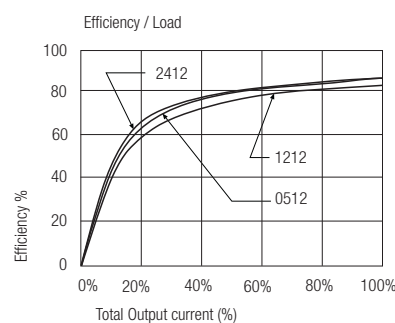

### RKZ-xx15D

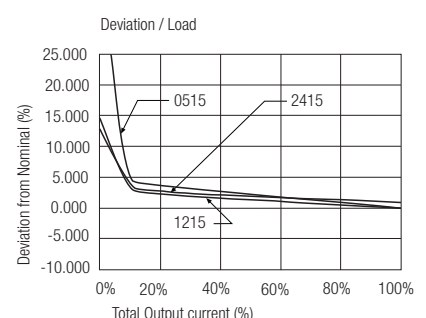
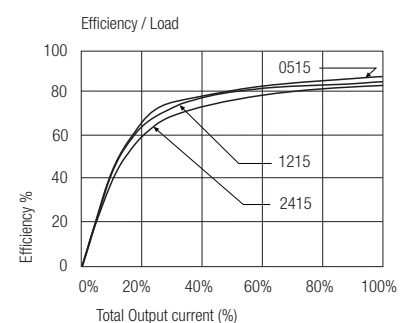

Application

**IGBT Application  
Circuit**

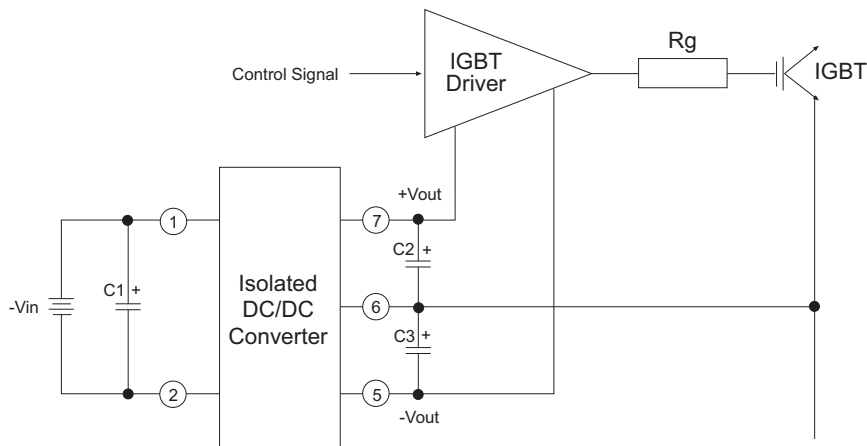

Package Style and Pinning (mm)

7 PIN SIP Package

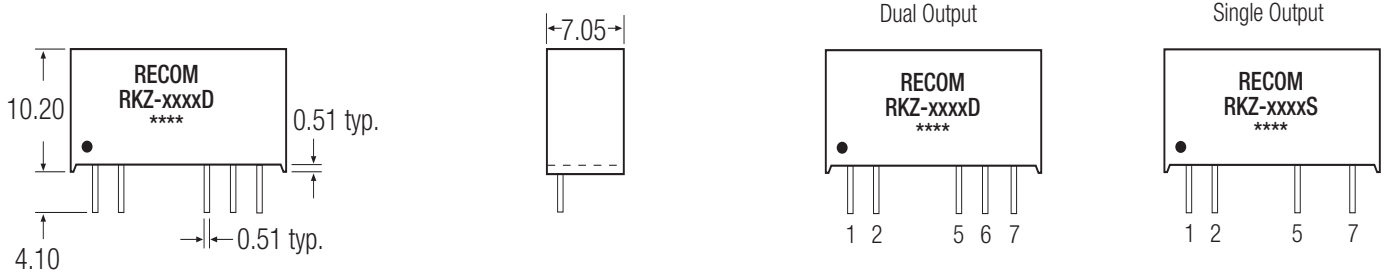

Recommended Footprint Details

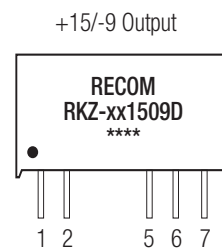
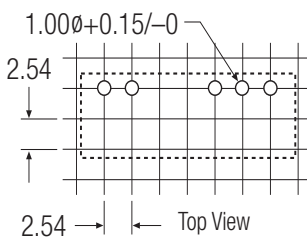
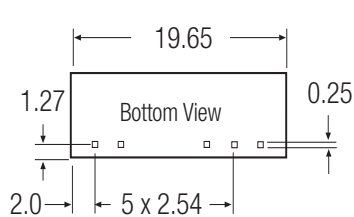

Pin Connections

Pin #	Single	Dual
1	+Vin	+Vin
2	-Vin	-Vin
5	-Vout	-Vout
6	No Pin	Com
7	+Vout	+Vout

NC = No Connection

XX.X ± 0.5 mm

XX.XX ± 0.25 mm