



ENGLISH

Datasheet

DC Axial Fan, 120 x 120 x 38.5mm, 178.5m/h, 6W, 12 V dc (OD1238 Series)

RS Stock number [619-6545](#)



RS Part Number	Speed (RPM)	Airflow (CFM)	Noise (db)	Volts (DC)	Voltage Range	Current (Amps)	Lead Type
6196545	2800	104	43	12	7.0~13.6	0.50	Wire
6196551	2800	104	43	12	7.0~13.6	0.50	Wire
6196567	2800	104	43	24	10~26	0.32	Wire
6196573	2800	104	43	24	10~26	0.32	Wire
6196589	2800	104	43	24	10~26	0.32	Wire
6196602	2800	104	43	48	28~55	0.20	Wire

*01: Indicates Tach Output, 5VTTL

Data Tolerance +/-10%

01A: Indicates Tach Output, Open Collector

20: Indicates Environmentally Protective Coating

Drawing(mm):

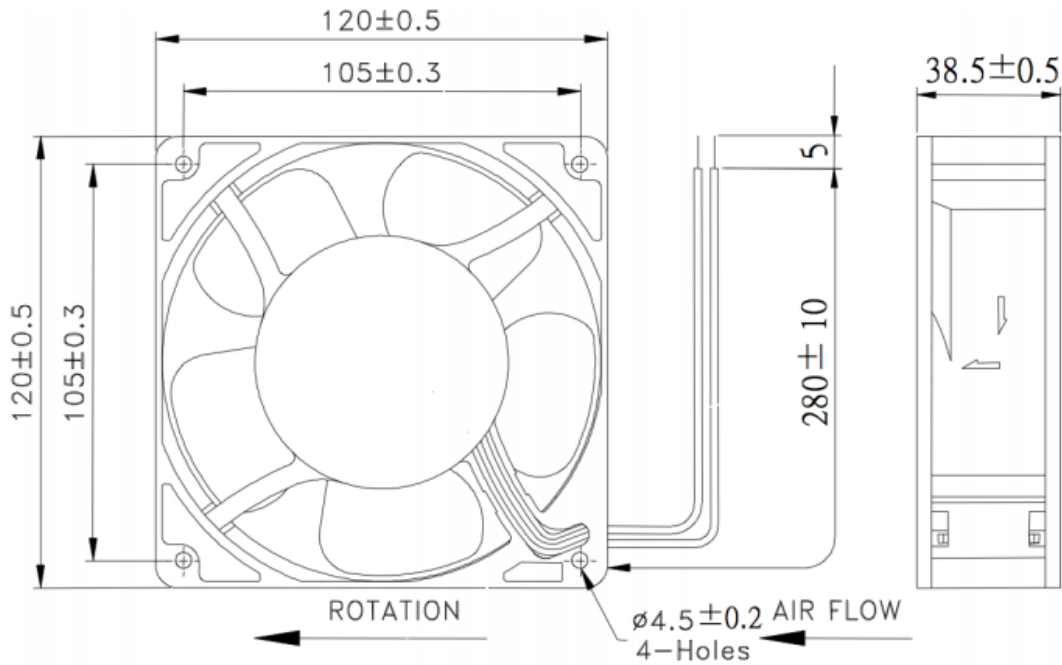

MOTOR

Brushless DC, polarity protected, locked rotor protected (current limited), auto restart

INSULATION RESISTANCE

Min. 10 M Ohm at 500VDC

LIFE EXPECTANCY (L10)

Ball Bearing 60,000 Hours

Operating Temperature

-10C ~ +70C

Safety Approvals

UL/CUL, TUV, CE

Frame and Impeller

PBT, UL94V-0 Thermoplastic

Available Options

Tachometer

Locked Rotor Alarm

Finger Guard: G109-15A, G109-15AB, G109-3

Plastic Guard: G120P

Wire Mesh Guard: WMG120M

Filter Kit: GRM120-30, GRM120-45